S P E C F I L E



Product Number : **PT-LW25H**

Product Name : LCD Projector

IDEHAL.ORG

Specifications

Main unit

Power supply		100–240 V AC, 50/60 Hz
Power consumption		297 W (0.47 W when STANDBY MODE set to ECO,* ¹ 8.6 W when STANDBY MODE set to NETWORK)
LCD panel	Panel size	15.0 mm (0.59 inches) diagonal (16:10 aspect ratio)
	Display method	Transparent LCD panel (× 3, R/G/B)
	Pixels	1,024,000 (1,280 × 800) × 3, total of 3,072,000 pixels
	Pixel configuration	Stripe
Lens		Manual zoom (1:1–1.2:1), manual focus F 2.10–2.25, f 19.11–22.94 mm
Throw ratio		1.5–1.8:1
Lamp		230 W UHM lamp
Screen size		0.76–7.62 m (30–300 inches) diagonally, 16:10 aspect ratio
Colors		Full color (16,777,216 colors)
Brightness* ²		2,500 lumens (LAMP MODE: HIGH)
Center-to-corner uniformity* ²		85%
Contrast* ²		3,000:1 (full on / full off) (LAMP MODE: HIGH, with iris on)
Resolution		1,280 × 800 pixels (Input signals that exceed this resolution will be converted to 1,280 × 800 pixels.)
Scanning frequency	RGB	fH: 15 kHz–100 kHz, fV: 50 Hz–100 Hz, dot clock: 140 MHz or lower (Signals above 140 MHz are downsampled.)
	YPbPr (YCbCr)	480i (525i): fH 15.75 kHz; fV 60 Hz, 576i (625i): fH 15.63 kHz; fV 50 Hz, 480p (525p): fH 31.50 kHz; fV 60 Hz, 576p (625p): fH 31.25 kHz; fV 50 Hz, 720 (750)/60p: fH 45.00 kHz; fV 60 Hz, 720 (750)/50p: fH 37.50 kHz; fV 50 Hz, 1080 (1125)/60i: fH 33.75 kHz; fV 60 Hz, 1080 (1125)/50i: fH 28.13 kHz; fV 50 Hz
	Video/S-Video	fH: 15.75 kHz, fV: 60 Hz [NTSC/NTSC4.43/PAL-M/PAL60] fH: 15.63 kHz, fV: 50 Hz [PAL/PAL-N/SECAM]
Optical axis shift		13:1 (fixed)
Keystone correction range		Vertical: ±30° (±20° with Real-Time Keystone)
Installation		Ceiling/desk, front/rear (menu selection)
Built-in speaker	Size	3.2 cm (1-1/4 inches) (round) × 1
	Output power	1 W (monaural)
Terminals	COMPUTER (RGB) 1 IN R, G, B	D-sub HD 15-pin (female) × 1 G: 0.7 Vp-p (1.0 Vp-p for sync on G), 75 ohms; B, R: 0.7 Vp-p, 75 ohms; HD/VD, SYNC: high impedance, TTL (positive/negative) NOTE: SYNC/HD and VD terminals do not accept tri-level sync signals.
	Y, Pb (Cb), Pr (Cr)	Y: 1.0 Vp-p (including sync signal); Pb (Cb), Pr (Cr): 0.7 Vp-p, 75 ohms
	S-Video	Y: 1.0 Vp-p; C: 0.286 Vp-p, 75 ohms NOTE: D-sub to S-Video adaptor cable ET-ADSV is required.
	COMPUTER (RGB) 2 IN / 1 OUT R, G, B	D-sub HD 15-pin (female) × 1 (input/output selectable using on-screen menu) G: 0.7 Vp-p (1.0 Vp-p for sync on G), 75 ohms; B, R: 0.7 Vp-p, 75 ohms; HD/VD, SYNC: high impedance, TTL (positive/negative) NOTE: SYNC/HD and VD terminals do not accept tri-level sync signals.
	VIDEO IN	RCA pin × 1, 1.0 Vp-p, 75 ohms
	COMPUTER AUDIO IN	M3 (L, R) × 1, 0.5 Vrms
	VIDEO/S-VIDEO AUDIO IN	RCA × 2 (L/R × 1), 0.5 Vrms
	SERIAL IN	D-sub 9-pin (male) × 1, for external control (RS-232C compliant)
	LAN	RJ-45 × 1, for network connection, 100Base-TX/10Base-T, compliant with PLink™

Power cord length	2.0 m (6 ft 7 in)
Cabinet materials	Molded plastic
Dimensions (W × H × D)	349 mm × 105 mm* ⁴ × 247 mm* ⁵ (13-3/4 × 4-5/32* ⁴ × 9-3/4* ⁵ inches)
Weight	Approximately 2.99 kg (6.6 lbs)
Operation noise	37.0 dB (LAMP MODE: HIGH), 34.1 dB (LAMP MODE: NORMAL), 29.0 dB (LAMP MODE: ECO)
Operating temperature	5–35 °C (41–95 °F)
Operating humidity	20%–80% (no condensation)
Remote control unit	
Power supply	3 V DC (R03/LR03/AAA type battery × 2)
Operation range* ⁶	Approximately 7 m (23 ft) when operated from directly in front of the signal receptor
Dimensions (W × H × D)	52 × 110 × 18 mm (2-1/16 × 4-11/32 × 23/32 inches)
Weight	Approx. 67 g (2.4 oz) (including batteries)
Supplied accessories	
	Power cord with security lock (× 1) (× 2 for PT-LW25HEA)
	Wireless remote control unit (× 1)
	Batteries for remote control (R03/AAA type × 2)
	VGA cable (× 1)
	Software CD-ROM (Logo Transfer Software, Multi Projector Monitoring and Control Software) (× 1)
	Filter cover (× 1)
Optional accessories	
Replacement lamp unit	ET-LAL100
Replacement filter unit	ET-RFL100
Ceiling mount bracket	ET-PKV100H (for high ceilings) ET-PKV100S (for low ceilings)
Bracket assembly	ET-PKL100B
D-sub to S-Video adaptor cable	ET-ADSV

Weights and dimensions shown are approximate. Specifications subject to change without notice.

*1 When the standby mode is set to eco, network functions such as power on over the LAN network will not operate. Also, only certain commands can be received for external control using the serial terminal.

*2 Measurement, measuring conditions, and method of notation all comply with ISO 21118 international standards.

*3 WUXGA resolution is supported only when the signals are compliant with VESA CVT-RB (Coordinated Video Timing-Reduced Blanking).

*4 With legs at shortest position.

*5 Protruding parts not included.

*6 Operation range differs depending on environments.

Dimensions

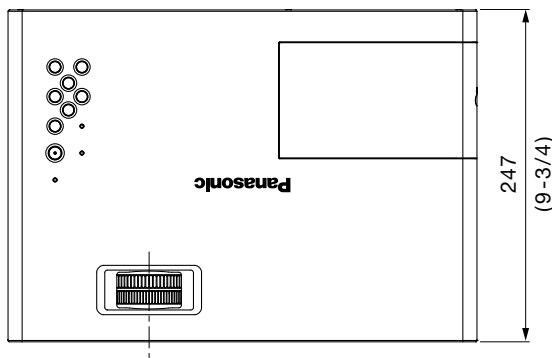

unit : mm (inch)

NOTE: This illustration is not drawn to scale.

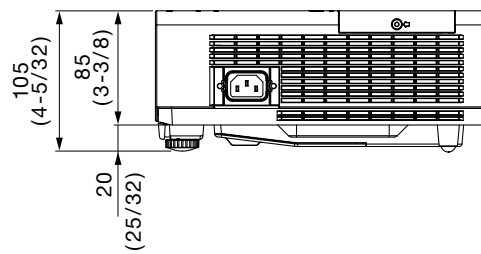
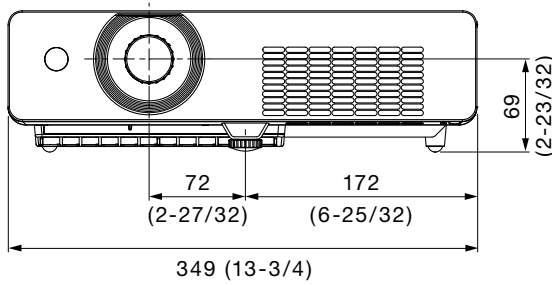

Terminals

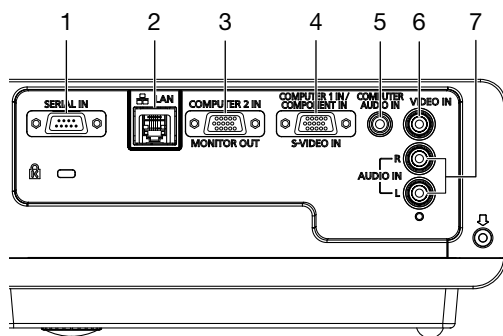

- 1 Serial input
- 2 LAN connector
- 3 Computer 2 input / computer 1 output
- 4 Computer 1 input
- 5 Audio input for computer
- 6 Video input
- 7 Audio input for video

Standard setting-up position

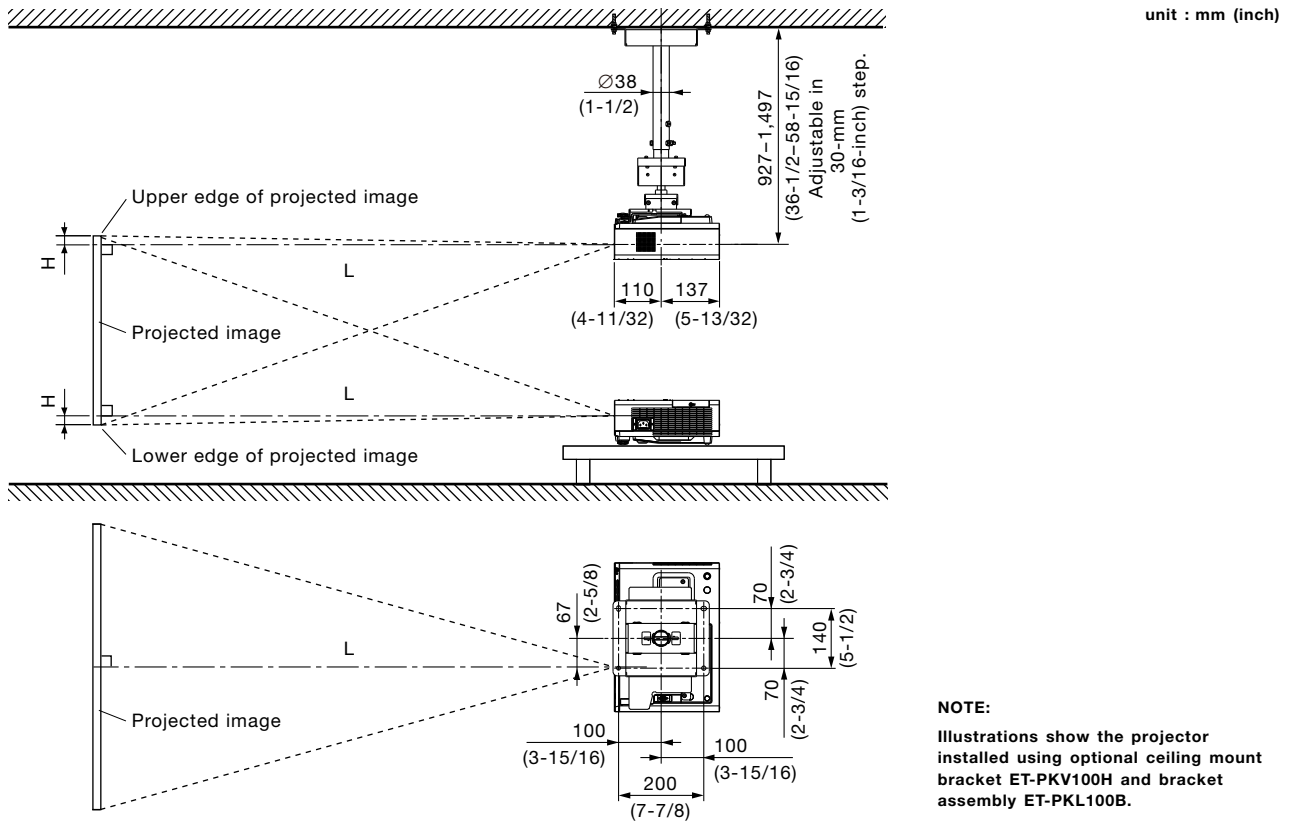

Caution:

- All construction work should be done by a qualified technician.
- When mounting to the ceiling, use the special mounting bracket. To prevent the projector from swaying or dropping, attach the wire that is included with the projector between the mounting bracket and the ceiling.

Projection distance for 16:10 aspect ratio screen

unit: meters (feet)

Projection size [diagonal]	Projection distance [L]		Height from the edge of screen to center of lens [H]
	Min [wide]	Max [telephoto]	
0.76 m / 30"	0.9 (3.1)	1.1 (3.7)	0.03 (0.10)
1.02 m / 40"	1.3 (4.2)	1.5 (5.0)	0.04 (0.13)
1.27 m / 50"	1.6 (5.2)	1.9 (6.3)	0.05 (0.16)
1.52 m / 60"	1.9 (6.3)	2.3 (7.5)	0.06 (0.20)
1.78 m / 70"	2.2 (7.3)	2.7 (8.8)	0.07 (0.23)
2.03 m / 80"	2.6 (8.4)	3.1 (10.1)	0.08 (0.26)
2.29 m / 90"	2.9 (9.4)	3.5 (11.3)	0.09 (0.30)
2.54 m / 100"	3.2 (10.5)	3.8 (12.6)	0.10 (0.33)
3.05 m / 120"	3.8 (12.6)	4.6 (15.1)	0.12 (0.39)
3.81 m / 150"	4.8 (15.8)	5.8 (18.9)	0.14 (0.46)
5.08 m / 200"	6.4 (21.1)	7.7 (25.3)	0.19 (0.62)
6.35 m / 250"	8.0 (26.3)	9.6 (31.6)	0.24 (0.79)
7.62 m / 300"	9.6 (31.6)	11.0* (36.1)*	0.29 (0.95)

* Lens performance cannot be guaranteed for projection sizes larger than 11.0 m (36.1 ft).

NOTE:

- The value for L (distance to screen) varies slightly depending on the zoom lens characteristics.
- At the shortest projection distance, the zoom lens characteristics may cause slight image distortion.

Projection distance for 16:9 aspect ratio screen

unit: meters (feet)

Projection size [diagonal]	Projection distance [L]		Height from the edge of screen to center of lens [H]
	Min [wide]	Max [telephoto]	
0.76 m / 30"	1.0 (3.2)	1.2 (3.8)	0.01 (0.03)
1.02 m / 40"	1.3 (4.3)	1.6 (5.1)	0.01 (0.03)
1.27 m / 50"	1.6 (5.4)	2.0 (6.4)	0.02 (0.07)
1.52 m / 60"	2.0 (6.4)	2.4 (7.7)	0.02 (0.07)
1.78 m / 70"	2.3 (7.5)	2.8 (9.0)	0.02 (0.07)
2.03 m / 80"	2.6 (8.6)	3.2 (10.3)	0.02 (0.07)
2.29 m / 90"	3.0 (9.7)	3.5 (11.6)	0.03 (0.10)
2.54 m / 100"	3.3 (10.8)	3.9 (12.9)	0.03 (0.10)
3.05 m / 120"	3.9 (13.0)	4.7 (15.6)	0.04 (0.13)
3.81 m / 150"	4.9 (16.2)	5.9 (19.5)	0.04 (0.13)
5.08 m / 200"	6.6 (21.6)	7.9 (26.0)	0.06 (0.20)
6.35 m / 250"	8.3 (27.1)	9.9 (32.5)	0.07 (0.23)
7.62 m / 300"	9.9 (32.5)	11.0* (36.1)*	0.09 (0.30)

* Lens performance cannot be guaranteed for projection sizes larger than 11.0 m (36.1 ft).

NOTE:

- The value for L (distance to screen) varies slightly depending on the zoom lens characteristics.
- At the shortest projection distance, the zoom lens characteristics may cause slight image distortion.

Calculation of the projection distance

For a screen size different from the above, use the equation below to calculate the projection distance.

Aspect ratio 16:10

minimum $L (m) = (\text{diagonal screen size in inches}) \times 0.0322 - 0.0233$

maximum $L (m) = (\text{diagonal screen size in inches}) \times 0.0386 - 0.0237$

Aspect ratio 16:9

minimum $L (m) = (\text{diagonal screen size in inches}) \times 0.0331 - 0.0233$

maximum $L (m) = (\text{diagonal screen size in inches}) \times 0.0397 - 0.0237$

NOTE:

Distances calculated with the above equations will include a slight error.

Installable angle

Install the projector at an angle within the range shown below.

• **Vertical direction**

The projector may be installed at a vertical angle of 30°.

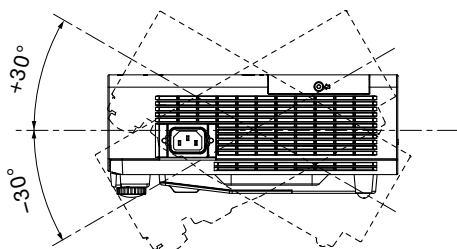

• **Horizontal direction**

The projector may be installed at a horizontal angle of 20°.

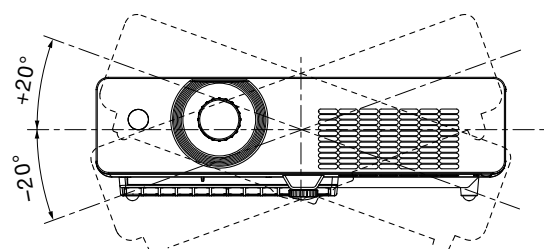

List of compatible signals

The signals that can be input to this projector are shown in the table below. Horizontal scanning frequencies of 15 kHz to 100 kHz, vertical scanning frequencies of 50 Hz to 100 Hz, and a dot clock of 140 MHz maximum can be input.

NOTE: The native resolution of this projector is 1,280 × 800 pixels. If the display resolution of the input signal is different from the native resolution, image compression or expansion will be used to convert the input signal to a level within the native resolution.

Display mode	Display resolution (dots)*1	Scanning frequency H (kHz)	V (kHz)	Dot clock frequency (MHz)	Format
NTSC/NTSC4.43/PAL-M/PAL60	720 × 480i	15.7	59.9	–	VIDEO/S-VIDEO*2
PAL/PAL-N/SECAM	720 × 576i	15.6	50.0	–	
480i (525i)	640 × 480i	15.7	59.9	12.3	YPbPr/RGB
576i (625i)	768 × 576i	15.6	50.0	14.8	
480p (525p)	640 × 480	31.5	59.9	25.2	
576p (625p)	768 × 575	31.3	50.0	29.5	
720p	1280 × 720	45.0	60.0	74.3	
		37.5	50.0	74.3	
1035i	1920 × 1035i	33.8	60.0	74.3	
1080i	1920 × 1080i	33.8	60.0	74.3	
		28.1	50.0	74.3	
VGA	640 × 400	31.5	70.1	25.2	RGB
	640 × 480	31.5	59.9	25.2	
		37.5	75.0	31.5	
		37.9	72.8	31.5	
		37.9	74.4	31.5	
		43.3	85.0	36.0	
	720 × 400	31.5	70.1	28.3	
MAC LC13	640 × 480	35.0	66.6	31.3	
MAC13		35.0	66.7	30.2	
SVGA	800 × 600	32.7	51.1	32.7	
		34.5	55.4	36.4	
		35.2	56.3	36.0	
		37.9	60.3	40.0	
		37.9	61.0	40.0	
		38.0	60.5	40.1	
		38.6	60.3	38.6	
		46.9	75.0	49.5	
		48.1	72.2	50.0	
		53.7	85.1	56.3	
MAC16	832 × 624	49.7	74.6	57.3	
XGA	1024 × 768	44.0	54.6	59.1	
		46.9	58.2	63.0	
		47.0	58.3	61.7	
		48.4	60.0	65.0	
		48.5	60.0	65.2	
		58.0	72.0	74.7	
		60.0	75.0	78.8	
		60.3	74.9	79.3	
		61.0	75.7	81.0	
		62.0	77.1	84.3	
		63.5	79.4	83.4	
		56.5	70.1	75.0	
		68.7	85.0	94.5	
	1024 × 768i	36.0	87.2	47.3	
		35.5	87.0	44.9	
MAC19	1024 × 768	60.2	75.1	80.0	

*1 The "i" appearing after the resolution indicates an interlaced signal.

*2 A D-sub to S-Video adaptor cable (ET-ADSV) is required for S-Video signal input.

Display mode	Display resolution (dots)*1	Scanning frequency		Dot clock frequency (MHz)	Format
		H (kHz)	V (kHz)		
WXGA	1280 × 768	47.8	59.9	79.5	RGB
		60.3	74.9	102.3	
		68.6	84.8	117.5	
	1280 × 800	41.2	50.0	68.6	
		49.6	60.1	79.4	
		49.7	59.8	83.5	
		56.0	70.0	95.0	
		57.6	72.0	97.8	
		58.2	70.0	98.9	
		60.0	72.0	102.8	
		62.8	74.9	106.5	
	1360 × 768	63.9	60.0	108.0	
		71.5	84.8	122.5	
		47.7	60.0	86.7	
		56.2	72.0	86.7	
1366 × 768	48.4	60.0	100.1		
1376 × 768	48.4	60.0	86.7		
MAC21	1152 × 870	68.7	75.1	100.0	
SXGA	1152 × 900	61.2	65.2	92.0	
		71.4	75.6	105.1	
		61.9	66.0	94.5	
	1280 × 960	60.0	60.0	108.0	
		62.5	58.6	108.0	
	1280 × 1024	63.3	60.0	107.3	
		63.7	60.0	109.5	
		63.9	60.0	108.0	
		71.7	67.2	117.0	
		81.1	76.1	135.0	
		64.0	60.2	108.1	
		80.0	75.0	135.0	
		63.4	60.0	111.5	
		77.0	72.0	130.1	
		63.8	60.2	109.5	
1280 × 1024i	91.1	85.0	157.5		
	50.0	86.0	80.0		
	50.0	94.0	80.0		
MAC	1280 × 960	46.4	86.7	78.4	
		75.0	75.1	126.0	
SXGA+	1400 × 1050	80.0	75.1	135.2	
		64.0	60.2	108.0	
WXGA+	1440 × 900	65.4	60.1	122.9	
		65.1	59.9	122.4	
		55.9	59.9	106.5	
UXGA	1600 × 1200	74.9	60.0	161.9	
		75.0	60.0	162.0	
		81.3	65.0	175.5	
		87.5	70.0	189.0	
WSXGA+	1680 × 1050	93.8	75.0	202.5	
		65.3	60.0	146.3	
WUXGA	1920 × 1200	74.0	59.9	154.0	
		74.6	59.9	193.3	

*1 The "i" appearing after the resolution indicates an interlaced signal.

Serial connector

The serial connector complies with RS-232C. To control the projector from a personal computer, commands must be input through communication software, based on the format and satisfying the communication conditions shown below.

Pin assignments and signal names

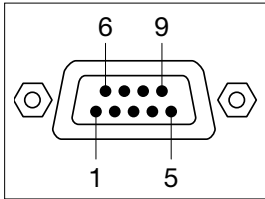

D-sub 9-pin (male)
Serial input

No.	Signal name	Description	No.	Signal name	Description
1	-	NC	6	-	NC
2	RXD	Receive data	7	-	NC
3	TXD	Send data	8	-	NC
4	-	NC	9	-	NC
5	GND	Ground			

Communication conditions (factory setting)

Signal level	RS-232C-compliant
Synchronization method	Start-stop synchronization
Baud rate	19,200 bps
Parity	None

Character length	8 bits
Stop bit	1 bit
X parameter	None
S parameter	None

Basic format

Transmission from the computer begins with STX, then command, parameter, and ETX are sent in this order. Add parameters according to the details of control.

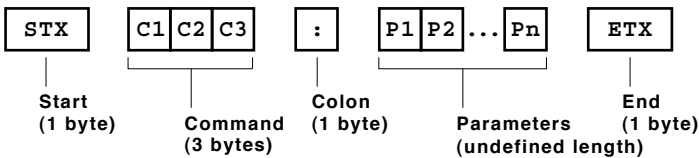

NOTE: When sending commands without parameters, a colon (:) is not necessary.

Basic format with sub-commands

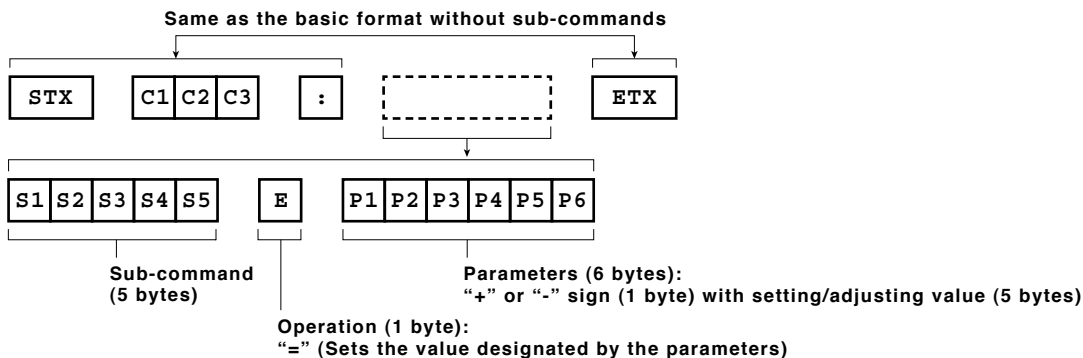

NOTE: When sending sub-commands that require no parameters, operation (E) and parameters are not necessary.

CAUTION

- It may not be possible to send or receive commands for about 10 to 60 seconds when the lamp is first turned on. If this occurs, wait for 60 seconds, then try sending or receiving again.
- When sending multiple commands, be sure to wait for at least 0.5 second after receiving a response from the projector before sending the next command.
- Additional time is sometimes required for response due to processing inside the projector. Set the time-out period for command response to 10 seconds or more.

Cable specifications

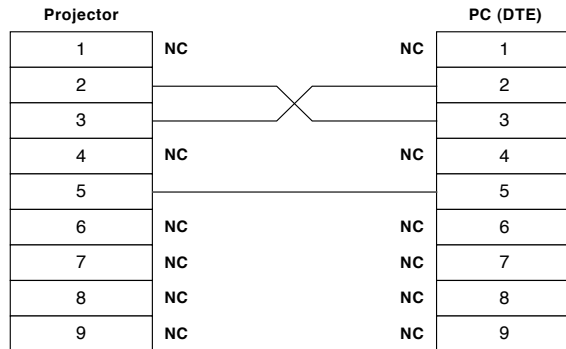

Control commands

Command: <Parameter>	Function	Callback: <Parameter>	Parameter value	
			Min	Max
PON*1/*2	Power on (standby mode on)	PON	-	-
POF*1	Power off (standby mode off)	POF	-	-
AVL:<p1>	Volume control	AVL:<p1>	0	63
IIS:<input signal>	Input signal selection	IIS:<input signal>	-	-
OFZ:<off on>	Freeze	OFZ:<off on>	0	1
VPM:STD	Picture mode: Standard	VPM:STD	-	-
VPM:DYN	Picture mode: Dynamic	VPM:DYN	-	-
VPM:CIN	Picture mode: Cinema	VPM:CIN	-	-
VPM:REA	Picture mode: Real	VPM:REA	-	-
VPM:BBD	Picture mode: Blackboard	VPM:BBD	-	-
VPM: CBD	Picture mode: Colorboard	VPM: CBD	-	-
VPM:IM1	Picture mode: Image 1	VPM:IM1	-	-
VPM:IM2	Picture mode: Image 2	VPM:IM2	-	-
VPM:IM3	Picture mode: Image 3	VPM:IM3	-	-
VPM:IM4	Picture mode: Image 4	VPM:IM4	-	-
AUU	Volume up	AUU	-	-
AUD	Volume down	AUD	-	-
OSH*1	AV mute	OSH	-	-
DZU	Digital zoom: Enlargement	DZU	-	-
DZD	Digital zoom: Reduction	DZD	-	-

*1 Do not send PON, POF, or OSH commands continuously in a short period of time. Doing so may burst the lamp or shorten the lamp replacement cycle.

*2 These commands are effective when the standby mode is set to eco. (Other commands are not effective.)

Status request commands

Command	Description	Callback <Parameter>
QPW	Standby power status	<power condition>
Q\$S	Lamp status	<lamp condition>
QIN	Input signal status	<input signal>
QAV	Volume adjustment value	<p1>
QPM	Picture mode status	Standard
		Dynamic
		Cinema
		Real
		Blackboard
		Colorboard
		Image 1
		Image 2
Image 3		
Image 4		
QFZ	Freeze status	<off on>
Q\$L	Lamp run time	<acctch>
QSH	AV mute function status	<off_on>

NOTE: If a wrong command is received, the projector will send an ER401 command to the computer.

Parameter format

Parameter format	Size (Byte)	Definition
<p1>	3 (1 or 2 bytes also possible when under control)	Decimal without signs: 0 to 999 (000, 001, 002...999) Decimal with signs: -99 to +99 (-99...-01, +00, +01, +02...+99) Callback from the projector is 3 Byte.
<off on>	1	0 = off, 1 = on
<input signal>	3	RG1 = computer 1, RG2 = computer 2, VID = video, SVD = S-Video
<power condition>	3	000 = power off (standby mode off), 001 = power on (standby mode on)
<lamp condition>	1	0 = standby, 1 = lamp on under control, 2 = lamp on, 3 = lamp off under control
<acctch>	4	Decimal without signs: 0000-9999 hours

NOTE: If a wrong command is received, the projector will send an ER401 command to the computer.

Command example

To set the volume to +30, send the command as shown below.

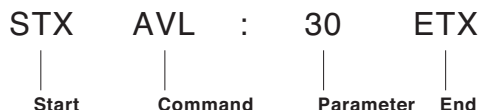

NOTE: When sending commands without parameters, a colon (:) is not necessary.

Notes on projector placement and operation

The projector uses a high-wattage lamp that becomes very hot during operation. Please observe the following precautions.

1. Never place objects on top of the projector while it is operating.
2. Make sure there is the unobstructed space as shown below or more around the projector's exhaust openings. In addition to this space, also ensure that there is a sufficient work space for removing and installing the lamp, filter and other parts.
3. Make sure that nothing blocks the projector's air intake and exhaust openings. Also, install the projector so that cool or hot air from other air conditioning equipment does not flow directly toward the projector's air intake or exhaust openings.
4. Do not install the projector in an enclosed space. If it is necessary to install it in an enclosed space, add a separate ventilation system. If ventilation is insufficient, hot air will accumulate at the intake opening. This may cause the projector's protective circuit to interrupt projector operation.

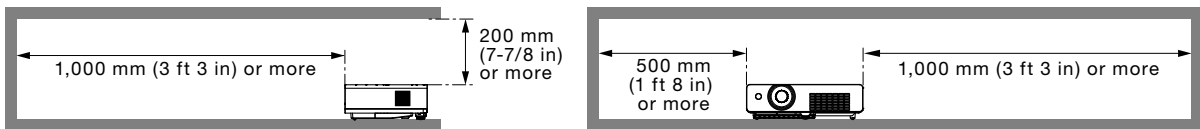

Direction of air intake and exhaust

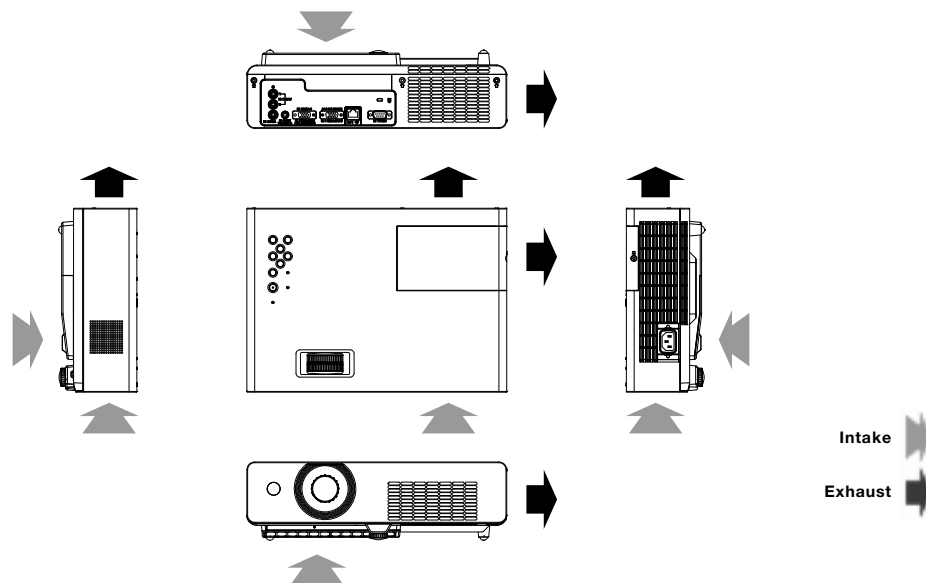

Operating the projector continuously

1. If the projector is to be operated continuously 6 hours or more, lamp replacement cycle duration becomes shorter.
2. The lamp replacement cycle duration becomes shorter if the projector is operated repeatedly for short periods (one hour or less).

Weights and dimensions shown are approximate. Specifications and appearance are subject to change without notice. Product availability differs depending on region and country. This product may be subject to export control regulations.

PJLink is a registered trademark, or a trademark application has been filed, in Japan, the United States, and other countries and regions. All other trademarks are the property of their respective trademark owners.