



---

**S P E C F I L E**

---

Product Number : **PT-TW350**

Product Name : LCD Projectors

IDEHAL.ORG

Specifications

Main unit

Power supply	AC100–240V 3.5A 50/60 Hz
Power consumption	300W 6W when Standby mode set to Normal, 0.5W when Standby mode set to Eco*1
LCD panel	Panel size 15.0 mm (0.59 inches) diagonal (16:10 aspect ratio)
	Display method Transparent LCD panel (× 3, R/G/B)
	Drive method Active matrix method
	Pixels 1,024,000 (1,280 × 800) × 3, total of 3,072,000 pixels
	Pixel configuration Stripe
Lens	Fixed zoom, manual focus F1.8 f 6.08mm
Throw ratio	0.46:1
Lamp	230 W UHM lamp
Lamp/Filter*2 Replacement Cycle	Normal: 5,000hrs / Eco1: 6,000hrs / Eco2: 10,000hrs
Screen size	50–100 inches (1.27–2.54 m) diagonally, 16:10 aspect ratio
Colors	Full color (16,777,216 colors)
Brightness*3	3,300 lumens (lamp power: normal)
Center-to-corner uniformity*3	80%
Contrast*3	16,000:1 (all white/all black, Image mode:Dynamic, Lamp control: Normal, Iris: On)
Resolution	1,280 × 800 pixels (Input signals that exceed this resolution will be converted to 1,280 × 800 pixels.)
Optical axis shift	7.25:1(fixed)
Keystone correction range	Vertical: ±15°, horizontal: ±15°
Installation	Ceiling/floor, front/rear (menu selection)
Built-in speaker	Output power 10 W (monaural) × 1
Terminals	HDMI IN HDMI 19-pin × 1, HDCP and Deep Color compatible Audio signal: linear PCM (sampling frequencies: 48 kHz, 44.1 kHz, 32 kHz)
	COMPUTER (RGB) 1 IN D-sub HD 15-pin (female) × 1 R, G, B R, G, B: 0.7 Vp-p, 75 ohms; HD/VD, SYNC: high impedance, TTL (positive/negative automatic)
	Y, Pb (Cb), Pr (Cr) Y: 1.0 Vp-p (including sync signal), 75 ohms Pb (Cb), Pr (Cr): 0.7 Vp-p, 75 ohms
	S-VIDEO Y: 1.0 Vp-p; C: 0.286 Vp-p, 75 ohms <b>NOTE: D-Sub -S video conversion cable (ET-ADSV) is required.</b>
	COMPUTER (RGB) 2 IN D-sub HD 15-pin (female) × 1 R, G, B R, G, B: 0.7 Vp-p, 75 ohms; HD/VD, SYNC: TTL (positive/negative automatic)
	MONITOR OUT D-sub HD 15-pin (female) × 1 R, G, B R, G, B: 0.7 Vp-p, 75 ohms; HD/VD, SYNC: TTL (positive/negative polarity compatible)
	VIDEO IN Pin jack × 1, 1.0 Vp-p, 75 ohms
	AUDIO IN 1 M3 (L, R) × 1, 0.5 Vrms
	AUDIO IN 2 Pin jack × 2 (L, R x 1), 0.5 Vrms
	AUDIO OUT M3 (L, R) × 1 (monitor out: 0–2.0 Vrms, variable)
	SERIAL IN D-sub 9-pin (female) × 1, for external control (RS-232C compliant)
	LAN RJ-45 × 1, for network connection, compliant with PLink™, 100Base-TX/10Base-T
	USB USB A (type A) connector × 1, for Memory Viewer/Wireless Module (Out put 5V MAX 500mA) USB B (type B) connector × 1, for USB Display

LCD Projectors

Power cord length	3 m (9 ft 10 in)
Cabinet materials	Molded plastic
Dimensions (W × H × D)	335 × 134.1** × 329 mm (13-3/16 × 5-1/4** × 12-15/16 inches)
Weight**	Approx. 3.9 kg (8.6 lbs)
Operation noise**	37 dB (Lamp power: Normal), 33 dB (Lamp power: Eco1) 28 dB (Lamp power: Eco2)
Operating temperature	5°C–40°C (41°F–104°F) [at less than 1,400 m (4,593 ft.) ;[High land]:[off] 5°C–35°C (41°F–95°F) [at 1,400 m to 2,700 m (4,593 ft. to 8,858 ft.);[High land]:[on 1 ] 5°C–30°C (41°F–86°F) [at 2,700 m to 3,000 m (8,858 ft. to 9,843 ft.);[High land]:[on 2 ]
Operating humidity	20%–80% (no condensation)

**Remote control unit**

Power supply	3 V DC (R03/LR03/AAA type battery × 2)
Operation range**	Approx. 5 m (16 ft 5 in) when operated from directly in front of the signal receptor
Dimensions (W × H × D)	44 × 105 × 20.5 mm (1-23/32 × 4-1/8 × 13/16 inches)
Weight	Approx. 63 g (2.22 oz) (including batteries)

**Supplied accessories**

- Power cord (Number and size of cords depends on region)
- Wireless remote control unit (× 1)
- Batteries for remote control (R03/LR03/AAA type × 2)
- Computer signal cable[VGA cable] 1.5 m [4 ft 11 in] (× 1)
- Software CD-ROM (Instruction Manual, Multi Monitoring and Control Software) (× 1)

**Optional accessories**

Ceiling Mount Bracket	ET-PKL100H (for high ceilings)
Ceiling Mount Bracket	ET-PKL100S (for low ceilings)
Projector Mount Bracket	ET-PKL430B
D-SUB - S-Video conversion cable	ET-ADSV
Replacement Lamp Unit	ET-LAL500
Replacement Filter Unit	ET-RFL300
Wireless Module	ET-WML100

**Power cord**

(One set is two cords)  
(K2CT3YY00080 × 1)  
(K2CM3YY00040 × 1)

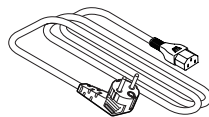
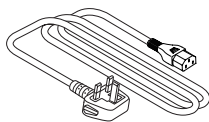

(U Model only × 1)  
(K2CG3YY00185)

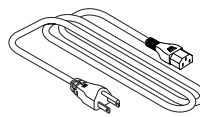

(D Model only × 1)  
(K2CZ3YY00062)

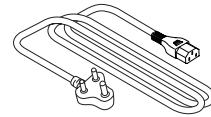

Weights and dimensions shown are approximate. Specifications subject to change without notice.

- \*1 When the Standby mode is set to Eco, network functions such as power on over the LAN network will not operate. Also, only certain commands can be received for external control using the serial terminal.
- \*2 Usage environment affects the duration of filter.
- \*3 Measurement, measuring conditions, and method of notation all comply with ISO 21118 international standards.
- \*4 With legs at shortest position.
- \*5 Average value. May differ depending on models.
- \*6 Operation range differs depending on environments.

**Dimensions**

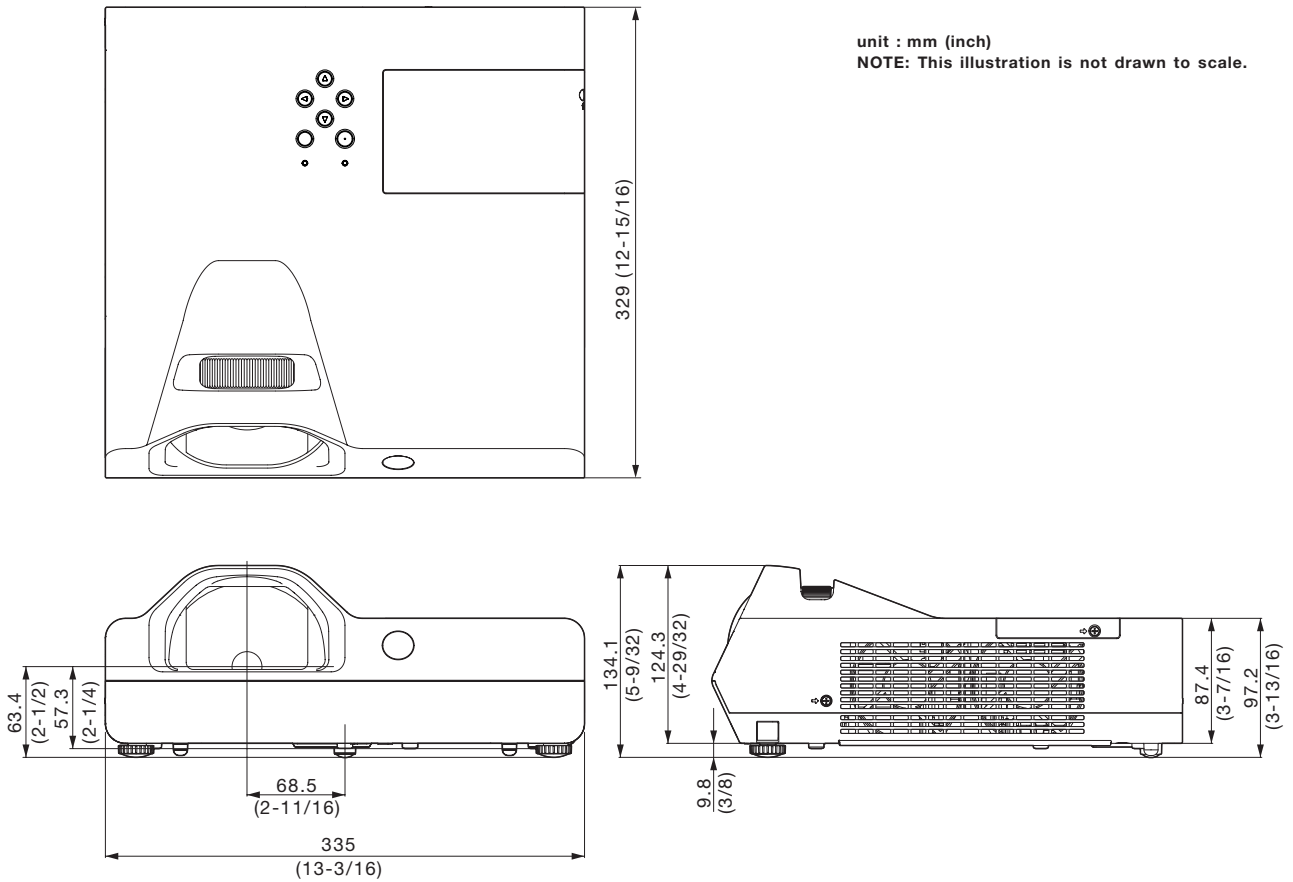

**Terminals**

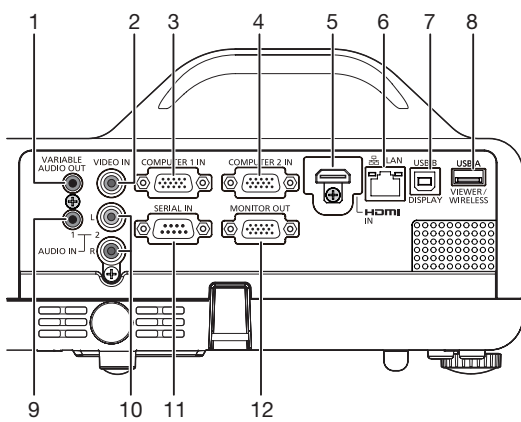

- 1 Audio output
- 2 Video input
- 3 Computer 1 input
- 4 Computer 2 input
- 5 HDMI input
- 6 LAN connector
- 7 USB B connector
- 8 USB A connector
- 9 Audio input 1
- 10 Audio input 2
- 11 Serial input
- 12 Monitor output

IDEHAL.ORG

Standard setting-up position

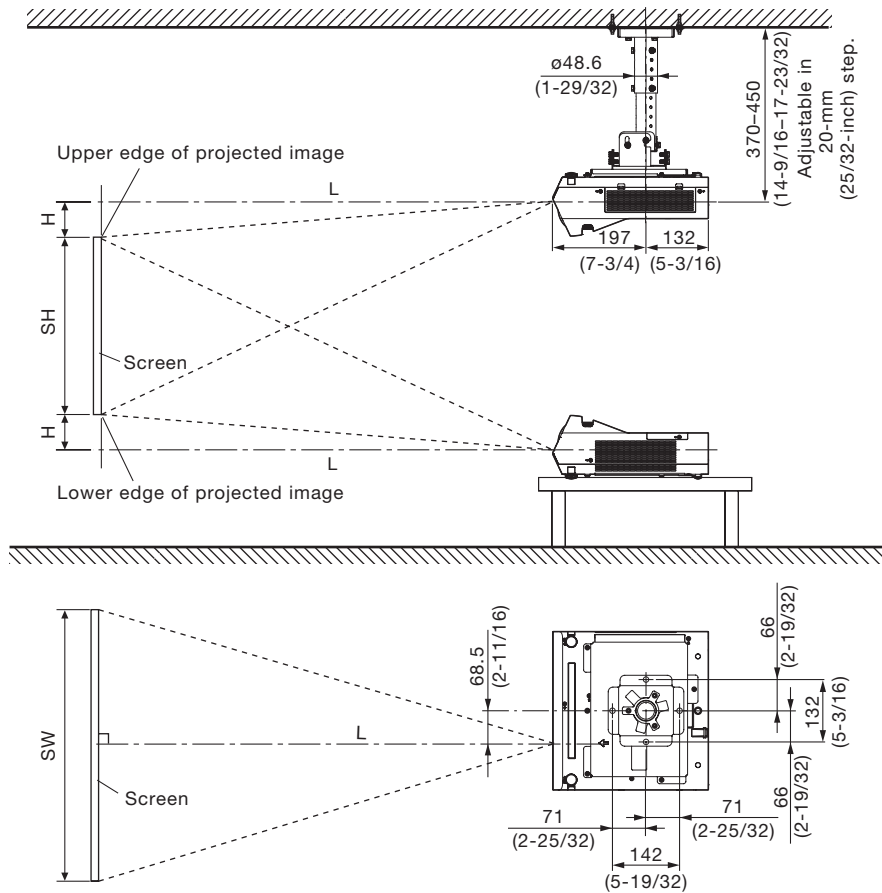

NOTE:

Illustrations show the projector installed using optional Ceiling Mount Bracket ET-PKL100H and Projector Mount Bracket ET-PKL430B. This illustration is not drawn to scale.

unit : mm (inch)

Caution:

- All construction work should be done by a qualified technician.
- When mounting to the ceiling, use the special mounting bracket. Furthermore, in order to prevent it from falling down from the ceiling, use the supplied wire on the Projector Mount Bracket.

Projection distance for 16:10 aspect ratio screen

unit: meters (feet)

Projection size [diagonal]	Projection distance [L]	Height from the edge of screen to center of lens [H]
1.27 m / 50"	0.48 (1.59)	0.11 (0.35)
1.52 m / 60"	0.59 (1.93)	0.13 (0.42)
1.78 m / 70"	0.69 (2.27)	0.15 (0.49)
2.03 m / 80"	0.80 (2.61)	0.17 (0.57)
2.29 m / 90"	0.90 (2.95)	0.19 (0.64)
2.54 m / 100"	1.00 (3.29)	0.22 (0.71)

**Projection distance for 16:9 aspect ratio screen**

unit: meters (feet)

Projection size [diagonal]	Projection distance [L]	Height from the edge of screen to center of lens [H]
1.27 m / 50"	0.50 (1.63)	0.15 (0.48)
1.52 m / 60"	0.60 (1.98)	0.17 (0.57)
1.78 m / 70"	0.71 (2.33)	0.20 (0.67)
2.03 m / 80"	0.82 (2.69)	0.23 (0.76)
2.29 m / 90"	0.92 (3.03)	0.26 (0.86)
2.54 m / 100"	1.03 (3.38)	0.29 (0.95)

**Projection distance for 4:3 aspect ratio screen**

unit: meters (feet)

Projection size [diagonal]	Projection distance [L]	Height from the edge of screen to center of lens [H]
1.27 m / 50"	0.55 (1.82)	0.11 (0.35)
1.52 m / 60"	0.67 (2.20)	0.13 (0.42)
1.78 m / 70"	0.79 (2.59)	0.15 (0.49)
2.03 m / 80"	0.91 (2.97)	0.17 (0.57)
2.29 m / 90"	1.02 (3.36)	0.19 (0.64)
2.54 m / 100"	1.14 (3.74)	0.22 (0.71)

**Calculation of the projection distance**

For a screen size different from the above, use the equation below to calculate the projection distance.

Aspect ratio 16:10

$$L (m) = (\text{diagonal screen size in inches}) \times 0.0104 - 0.0339$$

Aspect ratio 16:9

$$L (m) = (\text{diagonal screen size in inches}) \times 0.0106 - 0.0339$$

Aspect ratio 4:3

$$L (m) = (\text{diagonal screen size in inches}) \times 0.0117 - 0.0339$$

**NOTE:**

Distances calculated with the above equations will include a slight error.

**List of compatible signals**

The signals that can be input to this projector are shown in the table below. Horizontal scanning frequencies of 15 kHz to 91 kHz, vertical scanning frequencies of 24 Hz to 85 Hz, and a dot clock of 162 MHz maximum can be input.

**NOTE:** The native resolution of this projector is 1,280 × 800 pixels. If the display resolution of the input signal is different from the native resolution, image compression or expansion will be used to convert the input signal to a level within the native resolution.

Display mode	Display resolution (dots)*1	Scanning frequency		Dot clock frequency (MHz)	Format
		H (kHz)	V (Hz)		
NTSC/NTSC4.43/PAL60/PAL-M	720 × 480i	15.7	59.9	–	S-VIDEO/VIDEO
PAL/PAL-N/SECAM	720 × 576i	15.6	50.0	–	
480i(525i)	720 × 480i	15.7	59.9	13.5	YCbCr/RGB
576i(625i)	720 × 576i	15.6	50.0	13.5	
480i(525i)	720(1440) × 480i*2	15.7	59.9	27.0	HDMI
576i(625i)	720(1440) × 576i*2	15.6	50.0	27.0	
480p(525p)	720 × 483	31.5	59.9	27.0	HDMI/ YPbPr(YCbCr)/RGB
576p(625p)	720 × 576	31.3	50.0	27.0	
720(750)/60p	1280 × 720	45.0	60.0	74.3	
720(750)/50p		37.5	50.0	74.3	
1080(1125)/60i*3	1920 × 1080i	33.8	60.0	74.3	
1080(1125)/50i		28.1	50.0	74.3	
1080(1125)/24p	1920 × 1080	27.0	24.0	74.3	
1080(1125)/24sF	1920 × 1080i	27.0	48.0	74.3	
1080(1125)/25p	1920 × 1080	28.1	25.0	74.3	
1080(1125)/30p		33.8	30.0	74.3	
1080(1125)/60p		67.5	60.0	148.5	HDMI/RGB
1080(1125)/50p		56.3	50.0	148.5	
VGA	640 × 480	31.5	59.9	25.2	
		35.0	66.7	30.2	
		37.9	72.8	31.5	
		37.5	75.0	31.5	
		43.3	85.0	36.0	
SVGA	800 × 600	35.2	56.3	36.0	
		37.9	60.3	40.0	
		48.1	72.2	50.0	
		46.9	75.0	49.5	
		53.7	85.1	56.3	
MAC16	832 × 624	49.7	74.6	57.3	HDMI/RGB
XGA	1024 × 768	48.4	60.0	65.0	
		56.5	70.1	75.0	
		60.0	75.0	78.8	
		68.7	85.0	94.5	
1152 × 864	1152 × 864	67.5	75.0	108.0	HDMI/RGB
MAC21	1152 × 870	68.7	75.1	100.0	
1280 × 720	1280 × 720	37.1	49.8	60.5	
		44.8	59.9	74.5	

\*1 The “i” appearing after the resolution indicates an interlaced signal.

\*2 Only compatible with dot clock frequency of 27 MHz (pixel repetition signal)

Display mode	Display resolution (dots)*1	Scanning frequency		Dot clock frequency (MHz)	Format
		H (kHz)	V (Hz)		
1280 × 768	1280 × 768	47.8	59.9	79.5	HDMI/RGB
		60.3	74.9	102.3	
		68.6	84.8	117.5	
1280 × 800	1280 × 800	41.3	50.0	68.0	
		49.7	59.8	83.5	
		62.8	74.9	106.5	
		71.6	84.9	122.5	
1280 × 960	1280 × 960	60.0	60.0	108.0	
SXGA	1280 × 1024	64.0	60.0	108.0	
		80.0	75.0	135.0	
		91.1	85.0	157.5	
1366 × 768	1366 × 768	39.6	49.9	69.0	
		47.7	59.8	85.5	
1400 × 1050	1400 × 1050	65.3	60.0	121.8	
		82.3	74.9	156.0	
1440 × 900	1440 × 900	55.9	59.9	106.5	
1600 × 900	1600 × 900	55.9	60.0	119.0	
	1600 × 900*2	60.0	60.0	108.0	
UXGA	1600 × 1200	75.0	60.0	162.0	
1680 × 1050	1680 × 1050	65.3	60.0	146.3	
1920 × 1080	1920 × 1080*2	66.6	59.9	138.5	
WUXGA	1920 × 1200*2	74.0	60.0	154.0	

\*1 The "i" appearing after the resolution indicates an interlaced signal.

\*2 VESA CVT-RB (Reduced Blanking)-compliant.

Weights and dimensions shown are approximate. Specifications and appearance are subject to change without notice. Product availability differs depending on region and country. This product may be subject to export control regulations.

HDMI, the HDMI logo and High-Definition Multimedia Interface are trademarks or registered trademarks of HDMI Licensing LLC in the United States and other countries.

PJLink is a registered trademark, or a trademark application has been filed, in Japan, the United States, and other countries and regions. All other trademarks are the property of their respective trademark owners.