S P E C F I L E

Product Number : PT-**LX300**

Product Name : DLP™ Projector

Specifications

Main unit

Power supply		100–240 V AC, 50/60 Hz
Power consumption		218 W (0.5 W when STANDBY MODE set to ECO* ¹ , 6.0 W when STANDBY MODE set to NORMAL.* ²)
DLP™ chip	Panel size	14.0 mm (0.55 inches) diagonal (4:3 aspect ratio)
	Display method	DLP™ chip × 1, DLP™ system
	Pixels	786,432 (1,024 × 768) pixels
Lens		Manual zoom 1.1× (1.95–2.15:1 throw ratio), manual focus, F 2.41–2.53, f 21.8–24 mm
Lamp		190 W UHM lamp × 1
Screen size		0.76–7.62 m (30–300 inches), 4:3 aspect ratio
Brightness* ³		3,000 lumens (LAMP POWER: NORMAL, COLOR MODE: DYNAMIC)
Center-to-corner uniformity* ³		80%
Contrast* ³		4,000:1 (full on/off, LAMP POWER: NORMAL, input signal: RGB, Color mode: Dynamic)
Resolution		1,024 x 768 pixels (Input signals that exceed this resolution will be converted to 1,024 x 768 pixels.)
Scanning frequency	HDMI	f _H : 15 kHz–91.1 kHz, f _V : 24 Hz–85.1 Hz, dot clock 25–162 MHz
	RGB	f _H : 15 kHz–91.1 kHz, f _V : 24 Hz–85.1 Hz, dot clock: 162 MHz or lower
	YPbPr (YCbCr)	525i (480i): f _H 15.75 kHz; f _V 60 Hz, 625i (576i): f _H 15.63 kHz; f _V 50 Hz, 525p (480p): f _H 31.50 kHz; f _V 60 Hz, 625p (576p): f _H 31.25 kHz; f _V 50 Hz, 750 (720)/60p: f _H 45.00 kHz; f _V 60 Hz, 750 (720)/50p: f _H 37.50 kHz; f _V 50 Hz, 1125 (1080)/60i: f _H 33.75 kHz; f _V 60 Hz, 1125 (1080)/50i: f _H 28.13 kHz; f _V 50 Hz, 1125 (1080)/24p: f _H 27.00 kHz; f _V 24 Hz, 1125 (1080)/60p: f _H 67.50 kHz; f _V 60 Hz, 1125 (1080)/50p: f _H 56.25 kHz; f _V 50 Hz
	Video/S-Video	f _H : 15.75 kHz, f _V : 60 Hz [NTSC/NTSC4.43/PAL-M/PAL60] f _H : 15.63 kHz, f _V : 50 Hz [PAL/PAL-N/SECAM]
Optical axis shift		10:–1.5
Keystone correction range		Vertical: ±40° (manual)
Installation		Ceiling/floor, front/rear
Terminals	HDMI IN	HDMI 19-pin × 1 (Deep Color, compatible with HDCP) 525i(480i)* ⁴ , 625i(576i)* ⁴ , 525p (480p), 625p (576p), 750 (720)/60p, 750 (720)/50p, 1125 (1080)/60i, 1125 (1080)/50i, 1125 (1080)/24p, 1125 (1080)/60p, 1125 (1080)/50p, VESA CVT-RB compliant VGA (640 × 480) – UXGA (1,600 × 1,200), Audio signal: linear PCM (sampling frequencies: 48 kHz, 44.1 kHz, 32 kHz)
	COMPUTER (RGB) IN	
	R, G, B	D-sub HD 15-pin (female) × 1, G: 0.7 Vp-p (1.0 Vp-p for sync on G), 75 ohms; B, R: 0.7 Vp-p, 75 ohms; HD/VD, SYNC: high impedance, TTL (positive/negative)
	Y, Pb (Cb), Pr (Cr)	Y: 1.0 Vp-p (including sync signal); Pb (Cb), Pr (Cr): 0.7 Vp-p, 75 ohms
	VIDEO IN	Pin jack × 1, 1.0 Vp-p, 75 ohms
	MONITOR OUT	D-sub HD 15-pin (female) × 1
	AUDIO IN	Mini jack × 1 (monaural), 0.5 Vrms
	AUDIO OUT	Mini jack × 1 (monitor out: 0– 2.0 Vrms, variable)
	SERIAL IN	Mini DIN 3-pin (female) × 1 for external control (RS-232C compliant)
Built-in speaker		2 W (monaural)
Power cord length		1.8 m (5 ft 11 in) (2.0m (6 ft 7 in) for PT-LX300U)
Cabinet materials		Molded plastic (PC)

Dimensions (W × H × D)	286 mm × 100.6 mm* ⁵ × 192 mm (11-1/4 × 3-31/32* ⁵ × 7-9/16 inches)
Weight	Approx. 2.3 kg (5.1 lbs)
Operation noise* ³	34 dB (LAMP POWER: NORMAL), 29 dB (LAMP POWER: ECO)
Operating temperature	5°C – 40°C (41°F – 104°F) [Less than 750 m (2,500 ft) above sea level]; 5°C – 35°C (41°F – 95°F) [750 – 1,500 m (2,500 – 5,000 ft) above sea level]; 5°C – 30°C (41°F – 86°F) [1,500 – 3,000 m (5,000 – 10,000 ft) above sea level]
Operating humidity	20%–80% (no condensation)

Remote control unit

Power supply	3 V DC (Lithium coin cell battery x 1)
Operation range* ⁶	Approx. 8 m (26 ft 3 in) when operated from directly in front of the signal receptor
Dimensions (W × H × D)	40.6 × 86.5 × 7.2 mm (1-19/32 × 3-13/32 × 9/32 inches)
Weight	Approx. 23 g (0.8 oz) (including battery)

Supplied accessories

Power cord (× 1) (× 2 for PT-LX300EA)
Wireless remote control unit (× 1)
Battery for remote control (CR2025 type × 1)
Computer cable (for VGA) (× 1)

Optional accessories

Ceiling mount bracket	ET-PKV100H (for high ceilings) ET-PKV100S (for low ceilings)
Attachment for ceiling mount bracket	ET-PKL300B
Replacement lamp unit	ET-LAL320
Serial conversion cable	ET-ADRS

Weights and dimensions shown are approximate. Specifications and appearance are subject to change without notice.

*1 When [VGA Out (Standby)] / [In Standby Mode (Audio)] are all set to [Off].

*2 When [VGA Out (Standby)] / [In Standby Mode (Audio)] are all set to [On].

*3 Measurement, measuring conditions, and method of notation all comply with ISO 21118 international standards.

*4 Only compatible with dot clock frequency of 27 MHz (pixel repetition signal)

*5 With legs at shortest position.

*6 Operation range differs depending on environments.

Dimensions

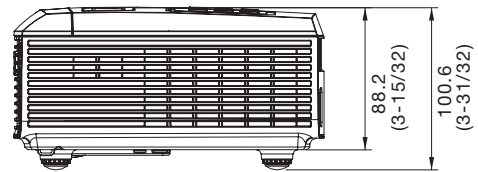
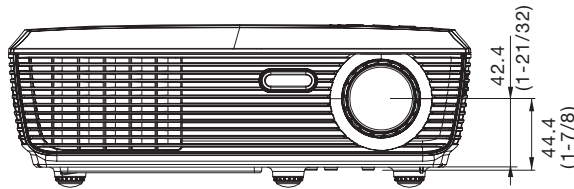
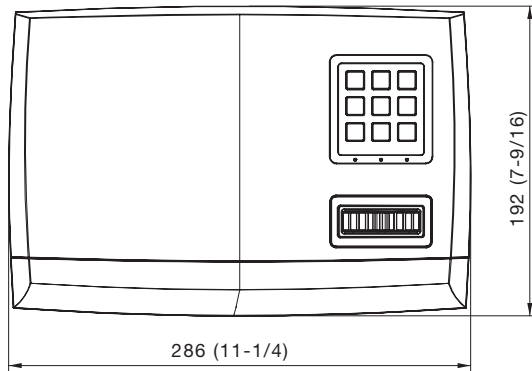

unit : mm (inch)

NOTE: This illustration is not drawn to scale.

Terminals

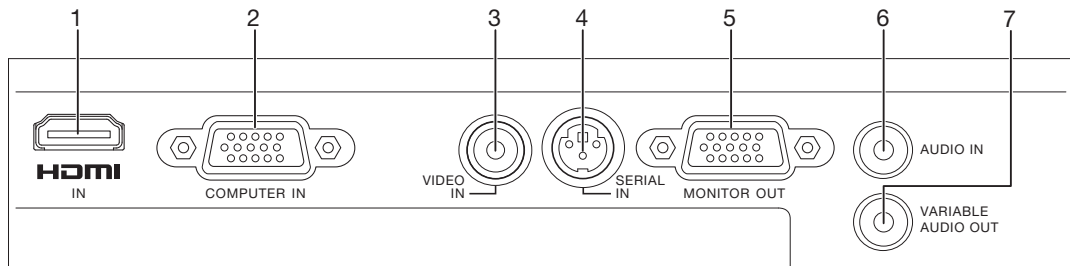

- 1 HDMI input
- 2 Computer input
- 3 Video input
- 4 Serial input
- 5 Monitor output
- 6 Audio input
- 7 Audio output

Standard setting-up position

unit : mm (inch)

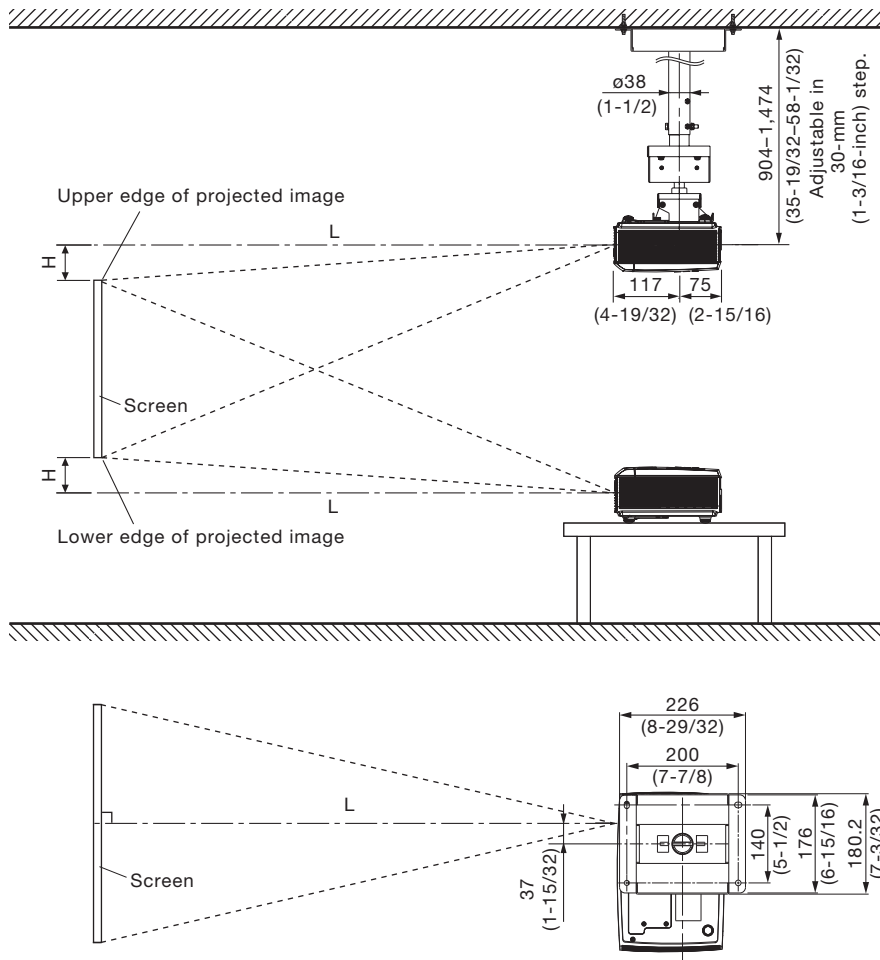

NOTE:

Illustrations show the projector installed using optional ceiling mount bracket ET-PKV100H and attachment ET-PKL300B.

This illustration is not drawn to scale.

Caution:

- All construction work should be done by a qualified technician.
- When mounting to the ceiling, use the special mounting bracket. Furthermore, in order to prevent it from falling down from the ceiling, use the supplied wire on the mounting bracket.

Projection distance for 4:3 aspect ratio screen

unit: meters (feet)

Projection size [diagonal]	Projection distance [L]		Height from the edge of screen to center of lens [H]
	Min [wide]	Max [telephoto]	
0.76 m / 30"	1.2 (3.9)	1.3 (4.3)	-0.07 (-0.23)
1.02 m / 40"	1.6 (5.2)	1.7 (5.6)	-0.09 (-0.30)
1.27 m / 50"	2.0 (6.6)	2.2 (7.2)	-0.11 (-0.36)
1.52 m / 60"	2.4 (7.9)	2.6 (8.5)	-0.14 (-0.46)
1.78 m / 70"	2.8 (9.2)	3.1 (10.2)	-0.16 (-0.52)
2.03 m / 80"	3.2 (10.5)	3.5 (11.5)	-0.18 (-0.59)
2.29 m / 90"	3.6 (11.8)	3.9 (12.8)	-0.21 (-0.69)
2.54 m / 100"	4.0 (13.1)	4.4 (14.4)	-0.23 (-0.75)
3.05 m / 120"	4.8 (15.7)	5.2 (17.1)	-0.27 (-0.89)
3.81 m / 150"	5.9 (19.4)	6.6 (21.7)	-0.34 (-1.12)
5.08 m / 200"	7.9 (25.9)	8.7 (28.5)	-0.46 (-1.51)
6.35 m / 250"	9.9 (32.5)	10.9 (35.8)	-0.57 (-1.87)
7.62 m / 300"	11.9 (39.0)	13.1 (43.0)	-0.69 (-2.26)

NOTE:

- The value for L (distance to screen) varies slightly depending on the zoom lens characteristics.
- At the shortest projection distance, the zoom lens characteristics may cause slight image distortion.

Calculation of the projection distance

For a screen size different from the above, use the equation below to calculate the projection distance.

Aspect ratio 4:3

minimum L (m) = (diagonal screen size in inches) × 0.03962 – 0

maximum L (m) = (diagonal screen size in inches) × 0.04369 – 0

NOTE:

Distances calculated with the above equations will include a slight error.

Installable angle

Install the projector at an angle within the range shown below.

• **Vertical direction**

The projector may be installed at a vertical angle of 20°.

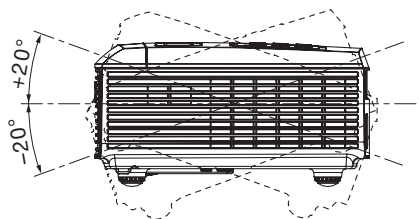

• **Horizontal direction**

The projector may be installed at a horizontal angle of 20°.

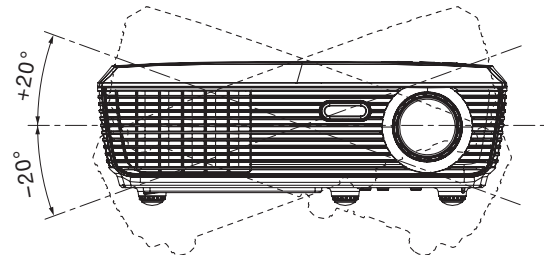

List of compatible signals

The signals that can be input to this projector are shown in the table below.

Display mode	Display resolution (dots) ¹	Scanning frequency		Dot clock frequency (MHz)	Format
		H (kHz)	V (Hz)		
NTSC/NTSC4.43/PAL-M/PAL60	720 × 480i	15.7	59.9	–	VIDEO/S-VIDEO
PAL/PAL-N/SECAM	720 × 576i	15.6	50.0	–	
525i (480i)	720 × 480i	15.7	59.9	27.0	HDMI
		15.7	59.9	13.5	YCbCr
625i (576i)	720 × 576i	15.6	50.0	27.0	HDMI
		15.6	50.0	13.5	YCbCr
525p (480p)	720 × 483	31.5	59.9	27.0	HDMI/YPbPr
625p (576p)	720 × 576	31.3	50.0	27.0	
750(720)/60p	1280 × 720	45.0	60.0	74.3	
750(720)/50p		37.5	50.0	74.3	
1125(1080)/60i	1920 × 1080i	33.8	60.0	74.3	
1125(1080)/50i		28.1	50.0	74.3	
1125(1080)/24p	1920 × 1080	27.0	24.0	74.3	
1125(1080)/60p		67.5	60.0	148.5	
1125(1080)/50p		56.3	50.0	148.5	
VGA	640 × 480	31.5	59.9	25.2	HDMI/RGB
		35.0	66.7	30.2	
		37.5	75.0	31.5	
		37.9	72.8	31.5	
		43.3	85.0	36.0	
SVGA	800 × 600	35.1	56.3	36.0	
		37.9	60.3	40.0	
		46.9	75.0	49.5	
		48.1	72.2	50.0	
		53.7	85.1	56.3	
MAC16	832 × 624	49.7	74.6	57.3	
XGA	1024 × 768	48.4	60.0	65.0	
		56.5	70.1	75.0	
		60.0	75.0	78.8	
		68.7	85.0	94.5	
WXGA	1280 × 720	44.8	60.0	74.5	
	1280 × 768	47.8	59.9	79.5	
	1280 × 768	60.3	74.9	102.3	
	1280 × 800	49.7	59.8	83.5	
	1366 × 768	47.7	59.8	84.8	
MAC21	1152 × 870	68.7	75.1	100.0	
MSXGA	1280 × 960	60.0	60.0	108.0	
		75.2	75.0	130.0	
SXGA	1280 × 1024	64.0	60.0	108.0	
		80.0	75.0	135.0	
		91.2	85.0	157.5	
SXGA+	1400 × 1050	65.3	60.0	121.8	
UXGA	1600 × 1200	75.0	60.0	162.0	

*1 The “i” appearing after the resolution indicates an interlaced signal.

Serial connector

The serial connector complies with RS-232C. To control the projector from a personal computer, commands must be input through communication software, based on the format and satisfying the communication conditions shown below.

Pin assignments and signal names

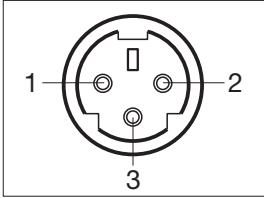

Mini DIN 3-pin (female)

Pin No.	Signal name	I/O
1	TXD	OUT
2	RXD	IN
3	GND	GND

Communication conditions (factory setting)

Signal level	RS-232C-compliant
Synchronization method	Start-stop synchronization
Baud rate	19,200 bps
Parity	None

Character length	8 bits
Stop bit	1 bit
X parameter	None
S parameter	None

Basic format

Transmission from the computer begins with STX, then command, parameter, and ETX are sent in this order. Add parameters according to the details of control.

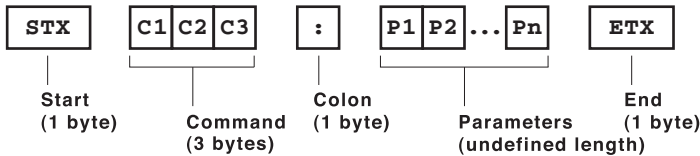

NOTE: When sending commands without parameters, a colon (:) is not necessary.

Basic format with sub-commands

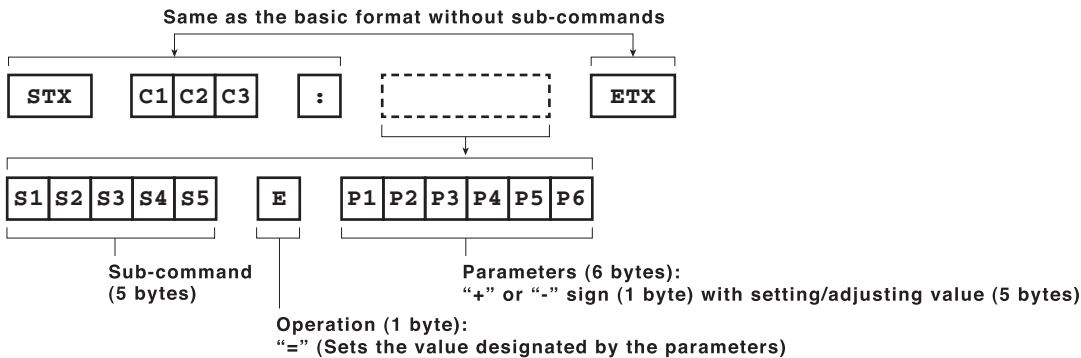

NOTE: When sending sub-commands that require no parameters, operation (E) and parameters are not necessary.

CAUTION

- It may not be possible to send or receive commands for about 10 to 60 seconds when the lamp is first turned on. If this occurs, wait for 60 seconds, then try sending or receiving again.
- When sending multiple commands, be sure to wait for at least 0.5 second after receiving a response from the projector before sending the next command.
- Additional time is sometimes required for response due to processing inside the projector. Set the time-out period for command response to 10 seconds or more.

Cable specifications

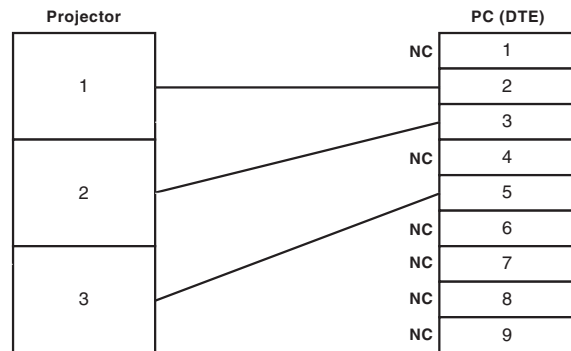

Control commands

Command : Parameter	Function		Callback
PON	POWER (STANDBY)	Standby power on	PON
POF		Standby power off	POF
IIS : HD1	INPUT SELECT	HDMI	IIS : HD1
IIS : RG		Computer	IIS : RG
IIS : VID		Video	IIS : VID
OSH : 0	AV MUTE	AV mute off	OSH : 0
OSH : 1		AV mute on	OSH : 1

- * Do not send PON, POF or OSH commands continuously in a short period of time. Doing so may burst the lamp or shorten the lamp replacement cycle.
- * When a command that cannot be executed during standby mode is sent, the projector will send an ER401 command in reply.

Status request commands

Command:Parameter	Function	Callback	Description
QPW	Main power status	000	Standby
		001	On
Q\$S	Lamp on status	0	Standby
		1	Lamp on control in progress
		2	Lamp on
		3	Lamp off control in progress
QSH	AV mute function status	0	Off
		1	On
QIN	Input signal status	HD1	HDMI
		RG	Computer
		VID	Video
QVX : RTMI 0	Projector run time	p1p2p3p4p5	0000h-9999h
Q\$L	Lamp run time	p1p2p3p4	0000h-9999h
QTM : 0	Temperature status	p1p2p3p4 / p5p6p7p8 (**)	p0 = Internal temperature

*1 p1p2p3p4: Celsius (°C), p5p6p7p8: Fahrenheit (°F)

NOTE: If a wrong command is received, the projector will send an ER401 or ER402 command to the computer.

Command example

To set the AV mute function off, send the command as shown below.

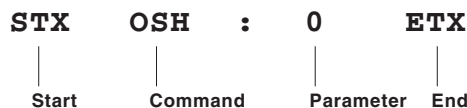

NOTE: When sending commands without parameters, a colon (:) is not necessary.

Notes on projector placement and operation

The projector uses a high-wattage lamp that becomes very hot during operation. Please observe the following precautions.

1. Never place objects on top of the projector while it is operating.
2. Make sure there is the unobstructed space as shown below or more around the projector's exhaust openings. In addition to this space, also ensure that there is a sufficient work space for removing and installing the lamp, filter and other parts.
3. Make sure that nothing blocks the projector's air intake and exhaust openings. Also, install the projector so that cool or hot air from other air conditioning equipment does not flow directly toward the projector's air intake or exhaust openings.
4. Do not install the projector in an enclosed space. If it is necessary to install it in an enclosed space, add a separate ventilation system. If ventilation is insufficient, hot air will accumulate at the intake opening. This may cause the projector's protective circuit to interrupt projector operation.

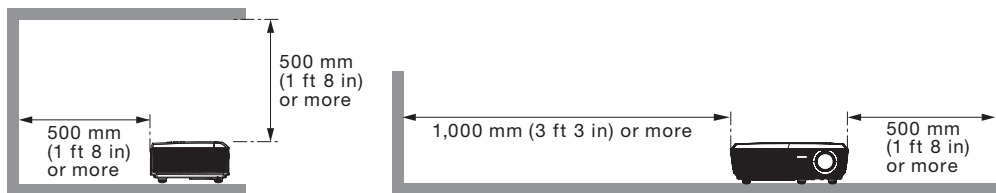

Direction of air intake and exhaust

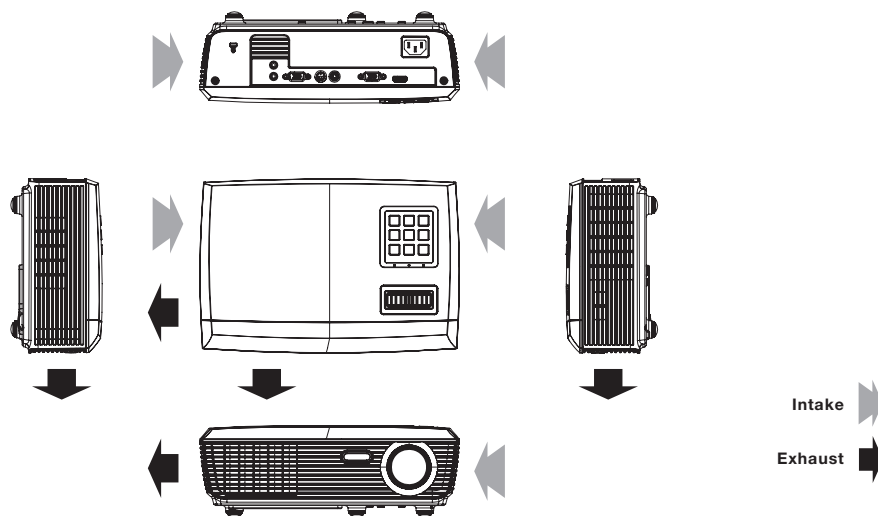

Operating the projector continuously

1. If the projector is to be operated continuously 22 hours or more, lamp replacement cycle duration becomes shorter.
2. The lamp replacement cycle duration becomes shorter if the projector is operated repeatedly for short periods (one hour or less).

Weights and dimensions shown are approximate. Specifications and appearance are subject to change without notice. Product availability differs depending on region and country. This product may be subject to export control regulations.

All other trademarks are the property of their respective trademark owners.