

Panasonic®

Operating Instructions IP Proprietary Telephone

Model No. **KX-NT400**



Thank you for purchasing an IP Proprietary Telephone (IP-PT).
Please read this manual carefully before using this product and save this manual for future use.
For more details, please refer to the manuals of the PBX.



SD Logo is
a trademark.

Introduction

Feature Highlights

Color LCD Touch Screen

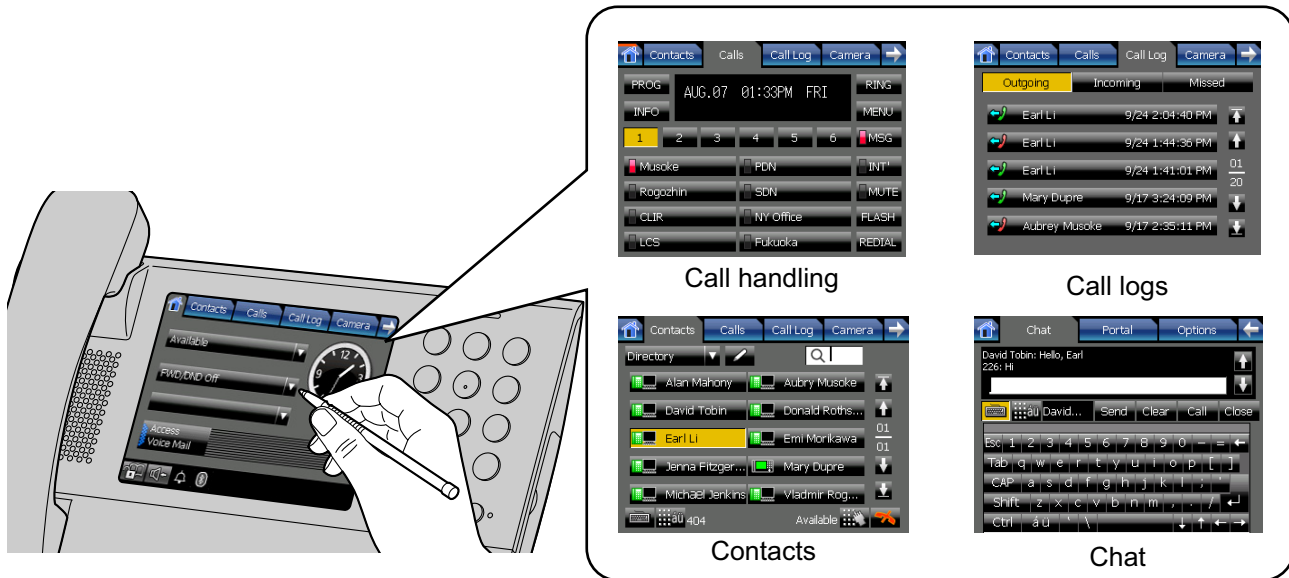

The large, color LCD touch screen provides a simple interface for operating the KX-NT400. You can assign commonly used phone numbers and functions to flexible keys for easy access. You can also check messages, missed calls, and more simply by pressing buttons on the screen. The touch screen also provides an intuitive interface for managing contacts and call logs.

Interact Efficiently with Other Users

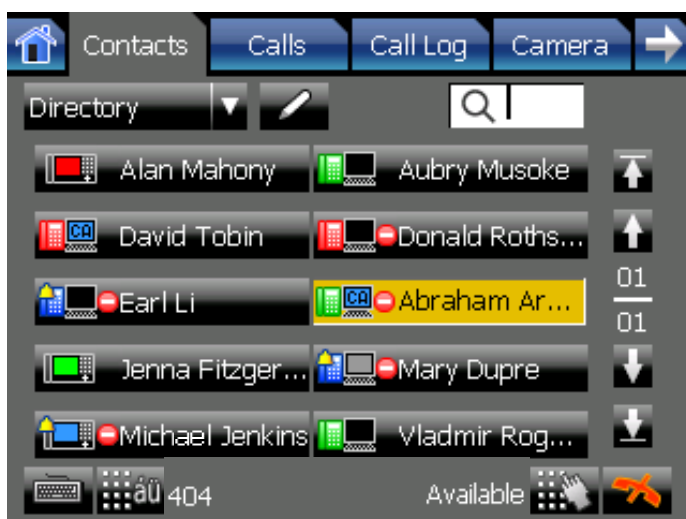

The KX-NT400 provides features that support interacting and working efficiently with other users. The following are examples of these features.

- Set a presence status, such as "**Available**" or "**In Conference**", that can be viewed by other users.
- View the state of other users' telephones.
- Establish a text chat session with other users.

Network Camera Integration



The KX-NT400 can display video feeds from Panasonic Network Cameras (e.g., KX-HCM/BB-HCM/BL-C series). You can register up to 20 cameras. If a registered camera is connected to a doorphone, whenever you make a call to or receive a call from that doorphone, the video feed is automatically displayed on the KX-NT400. In addition, you can register camera information with a contact, and view the camera's video feed when talking to the contact.

Portal



You can view intranet Web pages on the KX-NT400 via the portal (Web browser). This can be useful for accessing resources such as company news or an employee directory. You can also make calls directly from an intranet Web page that contains links to telephone numbers.

Data Import and Export to SD Memory Card

The KX-NT400 contains an SD memory card slot so that you can back up the KX-NT400's data to an SD memory card. You can back up information such as your personal contacts, chat log, and settings. If you switch phones or data is lost from the KX-NT400, you can recover your data from the SD memory card.

System Diagram

The figure below illustrates an example network setup using the KX-NT400.

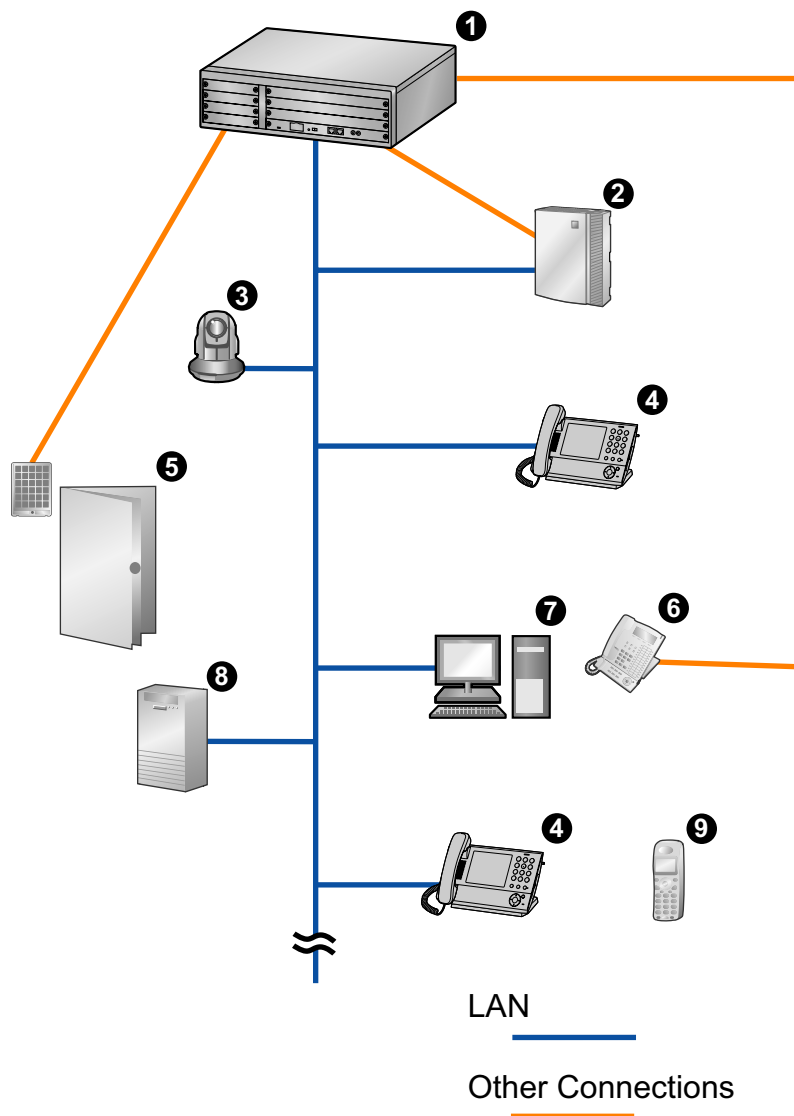

- ❶ Panasonic KX-NCP Series PBX
- ❷ Voice Processing System
- ❸ Panasonic Network Camera
- ❹ Panasonic KX-NT400
- ❺ Doorphone and Door Opener
- ❻ Proprietary Telephone or Single Line Telephone
- ❼ PC Running CA Client
- ❽ Web Server
- ❾ Portable Station

IMPORTANT

- If a PC that has Communication Assistant (CA) installed is connected to the KX-NT400, do not set the extension number in CA to the same extension number that is assigned to the KX-NT400.

Notice

- When a portable station is configured to share an extension number with the KX-NT400, to apply the configuration you must restart the KX-NT400.

Other Information

Included Documentation

Operating Instructions (this document)

Describes how to connect, use, program, and maintain the unit.

Note

- The contents and design of the software are subject to change without notice.

Trademarks

- The Bluetooth® word mark and logos are owned by the Bluetooth SIG, Inc. and any use of such marks by Panasonic Corporation is under license.
- All other trademarks identified herein are the property of their respective owners.

MPEG-4 Visual License

- This product is licensed under the MPEG-4 Visual patent portfolio license for the personal and non-commercial use of a consumer for (i) encoding video in compliance with the MPEG-4 Visual Standard ("MPEG-4 Video") and/or (ii) decoding MPEG-4 Video that was encoded by a consumer engaged in a personal and non-commercial activity and/or was obtained from a video provider licensed by MPEG LA to provide MPEG-4 Video. No license is granted or shall be implied for any other use. Additional information including that relating to promotional, internal, and commercial uses and licensing may be obtained from MPEG LA, LLC. See <http://www.mpegla.com>.

JPEG License

- The software of this product is based in part on the work of the Independent JPEG Group.

Fugue License

- This unit uses the "Fugue" flash file system by Kyoto Software Research Corporation. Fugue © 1999 - 2008 Kyoto Software Research, Inc. All rights reserved. You may not modify, decompile, disassemble, or reverse engineer the software.

Firmware Notice

- The firmware of the KX-NT400 is protected by copyright laws and international treaty provisions, and all other applicable laws. It can not be reverse engineered, decompiled, or disassembled.

For Future Reference

Record the information in the space below for future reference.

Note

- The serial number of this product may be found on the label affixed to the side of the unit. You should note the serial number of this unit in the space provided and retain this manual as a permanent record of your purchase to aid in identification in the event of theft.

MODEL NO.	_____
SERIAL NO.	_____
DATE OF PURCHASE	_____
NAME OF DEALER	_____
DEALER'S ADDRESS	_____ _____ _____
DEALER'S TEL. NO.	_____

For Your Safety

To reduce the risk of injury, loss of life, electric shock, fire, malfunction, and damage to equipment or property, always observe the following safety precautions.

Explanation of symbols

The following symbols are used to classify and describe the level of hazard and injury caused when the denotation is disregarded and improper use is performed.



WARNING

Denotes a potential hazard that could result in serious injury or death.



CAUTION

Denotes a hazard that could result in minor injury or damage to the unit or other equipment.

The following symbols are used to classify and describe the type of instructions to be observed.



This symbol is used to alert users to a specific operating procedure that must not be performed.









This symbol is used to alert users to a specific operating procedure that must be followed in order to operate the unit safely.





WARNING



General Safety

-  Do not disassemble this unit. Dangerous electrical shock could result. The unit must only be disassembled and repaired by qualified service technicians.
-  Never attempt to insert wires, pins, etc. into the vents or other holes of this unit.
-  To prevent possible fire or electric shock, do not expose this unit to rain or moisture.
-  If damage to the unit exposes any internal parts, immediately disconnect the cable or cord. If the power is supplied from the network to the IP-PT [Power-over-Ethernet], disconnect the Ethernet cable. Otherwise, disconnect the AC adaptor cord. Then return this unit to a service center.
-  This handset earpiece is magnetized and may retain small ferrous objects.
-  The use of excessive sound volume through earphone, headphones, or headsets may cause hearing loss.
-  Disconnect this unit from power outlet/the Ethernet cable if it emits smoke, an abnormal smell, or makes unusual noise. These conditions can cause fire or electric shock. Confirm that smoke has stopped and contact an authorized service center.

Installation

-  Do not use this unit near water, for example, near a bathtub, washbowl or sink. Damp basements should also be avoided.
-  The unit should only be connected to a power supply of the type described in the Operating Instructions or as shown on the label on the unit.

Placement

-  Care should be taken so that objects do not fall onto, and liquids are not spilled into, the unit. Do not subject this unit to excessive smoke, dust, moisture, mechanical vibration, shock, or direct sunlight.
-  Do not place heavy objects on top of this unit.



Place this unit on a flat surface.



Allow 10 cm (3 ¹⁵/₁₆ in) clearance around the unit for proper ventilation.



CAUTION



Keep the unit away from heating appliances and devices that generate electrical noise, such as fluorescent lamps, motors and televisions. These noise sources can interfere with the performance of the unit. It also should not be placed in rooms where the temperature is less than 5 °C (41 °F) or greater than 40 °C (104 °F).



Do not press or rub the LCD touch screen with too much force. A light touch is enough for the LCD touch screen to respond.



Wipe the unit with a soft cloth. Do not clean the unit with abrasive powders or with chemical agents such as benzene or thinner.



The SD memory card and the handset hook pose a choking hazard. Keep the SD memory card and the handset hook out of reach of children.



When left unused for a long period of time, disconnect the unit from the AC outlet. When the unit receives power from a PoE power supply, disconnect the LAN cable.

Notice

- If the unit does not operate properly, disconnect the AC adaptor cord and LAN cable and then connect again.
- If you are having problems making calls, disconnect the Ethernet cable and connect a known working IP-PT. If the known working IP-PT operates properly, have the defective IP-PT repaired by an authorized Panasonic factory service center. If the known working IP-PT does not operate properly, check the PBX and the Ethernet cable.
- Under power failure conditions, the IP-PT may not operate. Please ensure that a separate telephone, not dependent on local power, is available for use in remote sites in case of emergency.
- If an error message is shown on the unit's display, consult the network administrator.

- Use only the correct Panasonic handset.

Data Security

We recommend observing the security precautions described in this section, in order to prevent the following:

- loss, disclosure, falsification, or theft of user information
- unauthorized use of the unit
- interference or suspension of use caused by an unauthorized party

We cannot be responsible for damages resulting from the misuse of this product.

User information is defined as the following:

- Contacts' names, phone numbers, and IP addresses
- Call logs

Preventing Data Loss

- Keep a copy of all important data (such as contact lists) in case the machine malfunctions and data cannot be recovered.
- Use a personal computer to make periodic backups of recordings stored on the SD memory card.

Preventing Data Disclosure

- Do not leave the unit or SD memory card in a location where it can be accessed or removed without authorization.
- Store backups in a secure location.
- Do not store sensitive personal information in the unit.
- In the following situations, initialize the unit (see "Data Maintenance" on page 166), and remove the SD memory card from the unit.
 - Before disposing of the unit
 - Before handing the unit over to a third party
 - Before having the unit serviced
- Make sure the unit is serviced by only a certified technician.
- The confidentiality of the information on the SD memory card becomes the responsibility of the customer. To prevent data leakage, render the SD Memory Card physically unusable before disposal.
- When user information is sent from the KX-NT400 to a PC or other external device, the confidentiality of that information becomes the responsibility of the customer. Before disposing of the PC or other external device, ensure that data cannot be

retrieved from it by formatting the hard disk and/or rendering it physically unusable.

Preventing Data Disclosure Over the Network

- To ensure the security of private conversations, only connect the unit to a secure network.
- To prevent unauthorized access, only connect the unit to a network that is properly managed.
- Make sure all personal computers that are connected to the unit employ up-to-date security measures.

For Bluetooth® Headset Users

Medical:

Consult the manufacturer of any personal medical devices, such as pacemakers or hearing aids, to determine if they are adequately shielded from external RF (radio frequency) energy (the product operates in the frequency range of 2.4000 GHz to 2.4835 GHz and the power output is 2.5 mW [max.]). Do not use the product in health care facilities if any regulations posted in the area instruct you not to do so. Hospitals or health care facilities may be using equipment that could be sensitive to external RF energy.

Additional Information

Important Safety Instructions

When using this unit, basic safety precautions, including those below, should always be followed to reduce the risk of fire, electric shock and injury to persons.

1. Read and understand all instructions.
2. Follow all warnings and instructions marked on this unit.
3. Unplug this unit from the AC outlet before cleaning. Do not use liquid or aerosol cleaners. Clean with a damp cloth.
4. Do not use the unit near water, for example, near a bathtub, kitchen sink, or laundry tub, in a wet basement, or near a swimming pool.
5. Place this unit on a flat surface. Serious damage and/or injury may result if the unit falls.
6. The unit should never be placed near or over a radiator or other heat source.
7. This unit should be operated only from the type of power source indicated on the unit label. If you are not sure of the type of power supply to your home, consult your dealer or local power company.
8. Do not allow anything to rest on the power cord. Do not locate this unit where the cord may be stepped on or tripped on.
9. To reduce the risk of fire or electric shock, do not overload AC outlets and extension cords.
10. Do not insert objects of any kind into this unit through openings, as they may touch dangerous voltage points or short out parts that could result in a risk of fire or electric shock. Never spill liquid of any kind on the unit.
11. To reduce the risk of electric shock, do not disassemble this unit. Only qualified personnel should service this unit. Opening or removing covers may expose you to dangerous voltages or other risks. Incorrect reassembly can cause electric shock.
12. Unplug this unit from the AC outlet and have the unit serviced by qualified service personnel in the following cases:
 - A. When the power supply cord or plug is damaged or frayed.
 - B. If liquid has been spilled on the unit.
 - C. If the unit has been exposed to rain or water.
 - D. If the unit does not work normally by following the manual. Adjust only controls covered by the manual. Improper adjustment may require repair by an authorized service center.

E. If the unit has been dropped, or damaged.

F. If the unit's performance deteriorates.

13. Avoid using a telephone (other than a cordless type) during an electrical storm. There is a remote risk of electric shock from lightning.
14. Do not use the telephone in the vicinity of a gas leak to report the leak.

SAVE THESE INSTRUCTIONS

FCC and Other Information

This equipment has been tested and found to comply with the limits for a Class B digital device, pursuant to Part 15 of the FCC Rules. These limits are designed to provide reasonable protection against harmful interference in a residential installation. This equipment generates, uses, and can radiate radio frequency energy and, if not installed and used in accordance with the instructions, may cause harmful interference to radio communications. However, there is no guarantee that interference will not occur in a particular installation. If this equipment does cause harmful interference to radio or television reception, which can be determined by turning the equipment off and on, the user is encouraged to try to correct the interference by one or more of the following measures:

- Reorient or relocate the receiving antenna.
- Increase the separation between the equipment and receiver.
- Connect the equipment into an outlet on a circuit different from that to which the receiver is connected.
- Consult the dealer or an experienced radio/TV technician for help.

CAUTION

Any changes or modifications not expressly approved by the party responsible for compliance could void the user's authority to operate this device.

FCC Declaration of Conformity

Trade Name: Panasonic
 Model Number: KX-NT400
 Responsible Party:
 Panasonic Corporation of North America
 One Panasonic Way
 Secaucus, NJ 07094 U.S.A.
 Telephone No.: 1-800-211-PANA (7262)

This device complies with Part 15 of the FCC Rules.

Operation is subject to the following two conditions:
 (1) This device may not cause harmful interference, and
 (2) this device must accept any interference received, including interference that may cause undesired operation.

This equipment complies with Part 68 of the FCC rules and the requirements adopted by the ACTA. On the bottom of the cabinet of this equipment is a label that contains, among other information, the following product identifier:

US:ACJKXNANKX-NT400

If requested, this number must be provided to the telephone company.

If this equipment causes harm to the telephone network, the telephone company will notify you in advance that temporary discontinuance of service may be required. But if advance notice isn't practical, the telephone company will notify the customer as soon as possible. Also, you will be advised of your right to file a complaint with the FCC if you believe it is necessary.

The telephone company may make changes in its facilities, equipment, operations or procedures that could affect the operation of the equipment. If this happens the telephone company will provide advance notice in order for you to make necessary modifications to maintain uninterrupted service.

If trouble is experienced with this equipment, for repair or warranty information, please contact:
 Panasonic Service and Technology Company-BTS Center
 415 Horizon Drive Bldg. 300 Ste. 350-B
 Suwanee, GA 30024-3186

If the equipment is causing harm to the telephone network, the telephone company may request that you disconnect the equipment until the problem is resolved.

Connection to party line service is subject to state tariffs. Contact the state public utility commission, public service commission or corporation commission for information.

If your home has specially wired alarm equipment connected to the telephone line, ensure the installation of this equipment does not disable your alarm equipment. If you have questions about what will disable alarm equipment, consult your telephone company or a qualified installer.

WHEN PROGRAMMING EMERGENCY NUMBERS AND (OR) MAKING TEST CALLS TO EMERGENCY NUMBERS:

- a. Remain on the line and briefly explain to the dispatcher the reason for the call.
- b. Perform such activities in the off-peak hours, such as early morning or late evenings.

This equipment is hearing aid compatible.

This unit features a Bluetooth Module slot that can be used to wirelessly connect a Bluetooth headset to the unit.

Radio Frequency Exposure Requirements

(When an optional Bluetooth Module is installed)
 This product complies with FCC radiation exposure limits set forth for an uncontrolled environment. To comply with FCC RF exposure requirements, it must be installed and operated in accordance with provided instructions. The unit requires minimum 20 cm (8 in) spacing must be provided between antennas and all person's body (excluding extremities of hands, wrists and feet) during wireless modes of operation. This transmitter must not be colocated or operated in conjunction with any other antenna or transmitter.

Compliance with TIA-1083 standard



Telephone handsets identified with this logo have reduced noise and interference when used with T-Coil equipped hearing aids and cochlear implants.

Table of Contents

Before Operating the Telephone	17
Accessory Information	17
Location of Controls	18
Operation Board Angle Adjustment	23
Hooking the Handset	25
Screens & Soft Buttons	27
Navigation	27
HOME Screen	29
Contacts Screen	32
Calls Screen	37
Calls Screen in Line Buttons Mode	37
Calls Screen in Call List Mode	40
Call Log Screen	47
Camera Screen	49
Chat Screen	52
Portal Screen	54
Feature Key Screen	55
Options Screen	57
Basic Operations	58
Confirming Your Extension Number	58
Going off- and on-hook	58
Adjusting the Volume	58
Basic Screen Operations	59
Entering Text	60
Basic Feature Operation	62
Making Calls	62
Making a Call	62
Making a Call from the Contact List	63
Dialing by Using Call Logs	65
Redialing the Last Number You Dialed (Redial, Last Number)	66
One-touch Dialing	66
Receiving Calls	67
Receiving a Call	67
Redirecting Calls	68
During a Conversation	69
Holding a Call	69
Receiving a Second Call (Answering Call Waiting)	70
Talking to Two Parties Alternately (Call Splitting)	71
Transferring a Call (Call Transfer)	71
Mute	72
Recording Calls (Two-way Recording)	72
Conference Call (Multiple Party Conversation)	73
Making a Conference Call	73
Removing a Participant from the Conference	74
Leaving a Conference (Unattended Conference)	74
Locking Operations (Application Lock)	75
Checking Messages	76
Checking New Messages	76
Accessing Voice Mail	77
Checking Missed Calls	78
Presence Status Setting	78



Call Forwarding/Do Not Disturb	79
Advanced Feature Operation	81
Network Camera	81
Selecting Cameras to View	81
Zooming In and Out	81
Adjusting the Angle of the Camera	82
Opening Doors	82
Full-Screen Mode	82
Chat	83
Making a Call to a Chat Participant	83
Portal (Web Browser)	84
Selecting a URL to Access	84
Going Back to Your Homepage	84
Making Calls from the Portal	84
Other Feature Operations	86
When the Dialed Line is Busy or There is No Answer	86
Sending a Call Waiting Notification (Call Waiting)	86
Leaving a Message Waiting Indication	86
Leaving a Voice Message	86
Reserving a Busy Line (Automatic Callback Busy)	87
Joining an Existing Conversation (Executive Busy Override)	87
Overriding Do Not Disturb (DND Override)	87
If a Host PBX is Connected	88
Accessing External Services (External Feature Access [EFA])	88
PBX Feature List	89
Customizing the Telephone	108
Contact List	108
Adding a New Contact	108
Adding a Contact from a Call Log	108
Adding a Contact from the PBX	109
Adding a Contact from an LDAP Directory	109
Editing a Contact	109
Deleting a Contact	109
Details for Contacts	109
User Options	113
Password Settings	113
Display Settings	113
Dial Number Settings	114
Language Settings	115
Directory List Select Settings	115
IP Camera Settings	116
IP Camera Selection Buttons Settings	117
Portal Settings	117
Presence Settings	118
Administrator Options	121
LDAP Server Settings	121
Dial Modification Settings	122
PT Programming	125
Customizing the Flexible Buttons	133
Entering Characters	145

Installation and Settings	147
Connections	147
Wall Mounting	150
Bluetooth Headset Connections	153
Installation	153
Bluetooth Headset Operation	155
Setting Up the KX-NT400	157
Accessing the Start-up Settings	157
Language Settings	159
IP Address Settings	159
IP Port Settings	160
Quality of Service (QoS) Settings	161
Maintenance	162
Firmware Version Update	163
Setting Initialize	165
Firmware Version	165
Error Log	166
Maintaining the KX-NT400	166
Data Maintenance	166
Initializing the KX-NT400	168
Restarting the KX-NT400	168
Cleaning the KX-NT400	169
Appendix	170
Specifications	170
Programming Items	171
User Options	171
Administrator Options	176
Firmware Version Update	180
SD Memory Cards	181
Important Information	181
Compatible SD Memory Cards	181
Inserting and Removing SD Memory Cards	181
Write Protection (LOCK)	181
Formatting SD Memory Cards	182
Troubleshooting	183
Common Issues and Solutions	183
Error Messages	192
Error Codes	193
Index.....	197

Before Operating the Telephone

Accessory Information

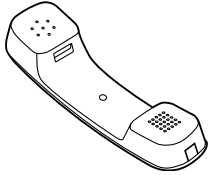
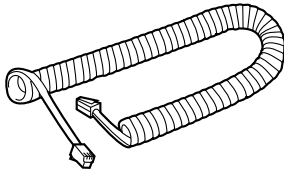
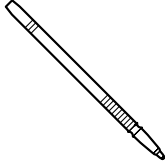
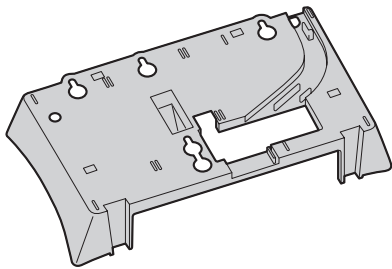
Included Accessories^{*1}

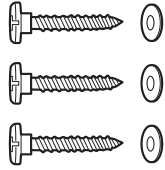
Handset (1)	Handset Cord (1)
	
Stylus Pen (1)	Wall Mounting Adaptor (1)
	
Screws for Adaptor (2)	Screws and Washers for Wall (3 each)
	

^{*1} For extra orders for the accessories, call toll-free: 1-800-332-5368.

Optional Accessories

AC Adaptor	KX-A420 (PSLP1662)
Bluetooth Module	KX-NT307 (PSLP1528)
Headset	KX-TCA86/KX-TCA92

Location of Controls

Front View

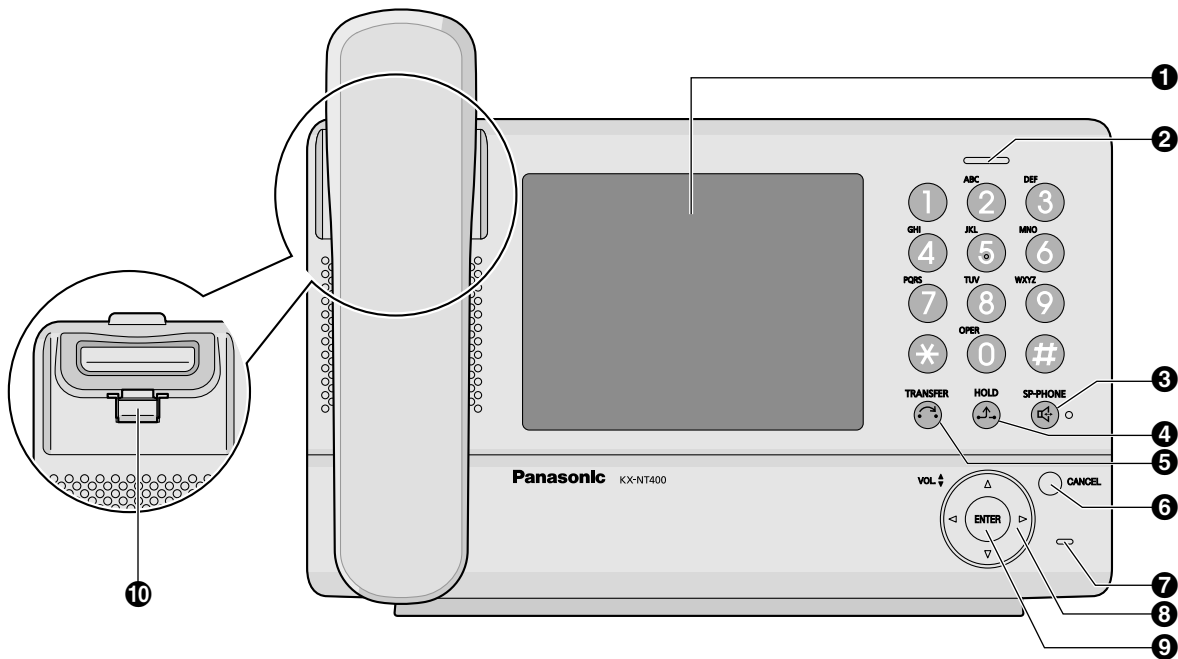

1 LCD (Liquid Crystal Display)

2 Message/Ringer Lamp

When you receive an intercom call, the lamp flashes green, and on an outside call, the lamp flashes red. When someone has left you a message, the lamp stays on red.

3 SP-PHONE (Speakerphone)

Used for performing hands-free operations. When the SP-PHONE is used, the lamp next to the SP-PHONE button turns red.

4 HOLD

Used to put a call on hold.

5 TRANSFER

Used to transfer a call to another party.

6 CANCEL

Used to cancel the selected item.

7 MIC

Used for hands-free conversation.

8 Navigator Key

Used to adjust the volume or select desired items.

9 ENTER

Used to assign the selected item.

10 Handset Hook

Keeps the handset stable when the KX-NT400 is mounted on a wall. For details, see "To Lock the Handset Hook when the KX-NT400 is Wall Mounted (Page 25)".

Right Side View

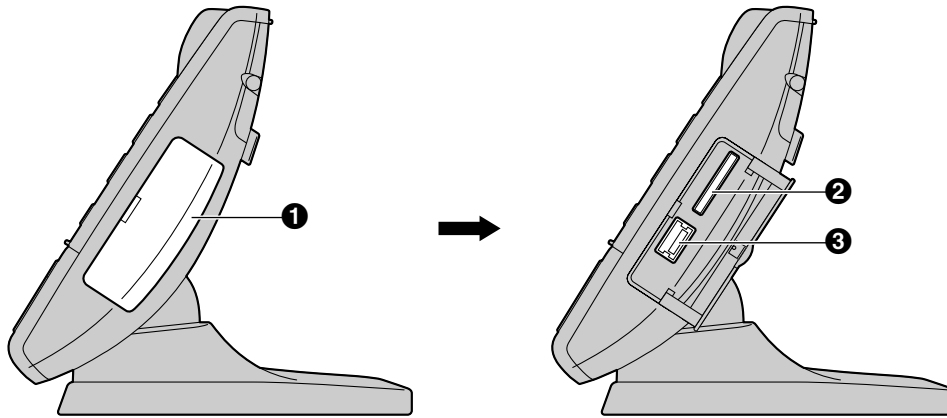

❶ Side Cover

❷ SD Memory Card Slot

Used to insert an SD memory card. SD memory cards are used to backup and restore personal settings and data. For details, see "SD Memory Cards (Page 181)".

❸ USB Port

Used to connect a USB keyboard.

Left Side View

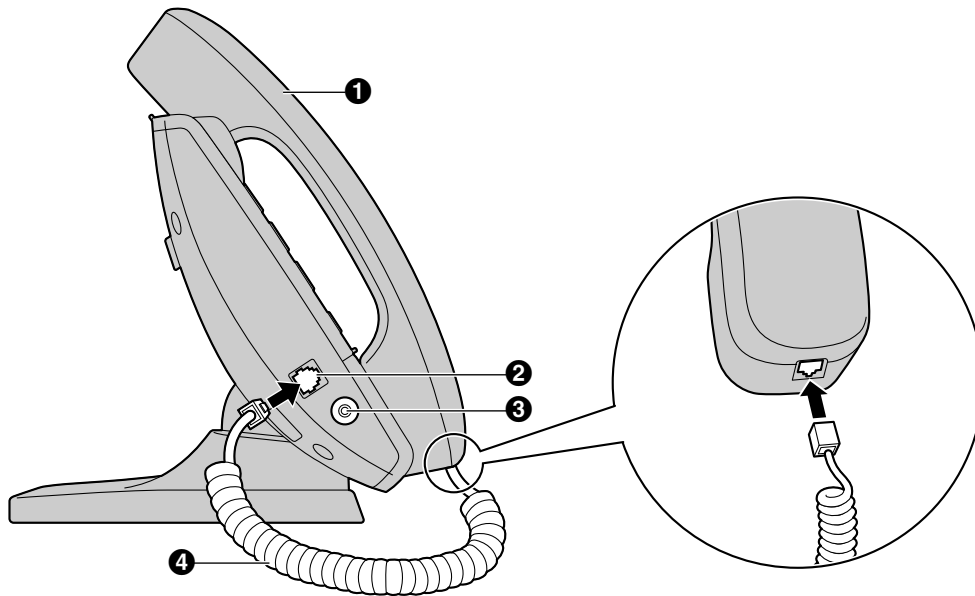

- ❶ Handset
- ❷ Handset Jack
- ❸ Headset Jack
- ❹ Handset Cord

For details, see "Connections (Page 147)".

Back View

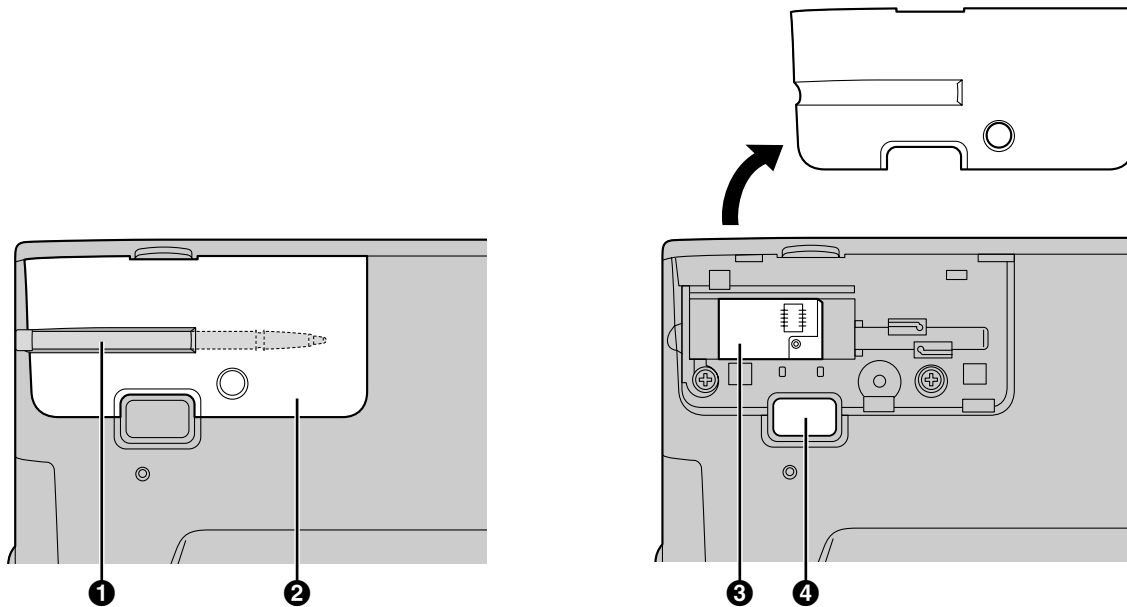

- ❶ Stylus Pen**
Used to press buttons on the LCD.
- ❷ Back Cover**
- ❸ Bluetooth Module Socket**
For details, see "Bluetooth Headset Connections (Page 153)".
- ❹ Operation Board Angle Adjust Button**
Used to adjust the angle of the operation board.
For details, see "Operation Board Angle Adjustment (Page 23)".

Bottom View

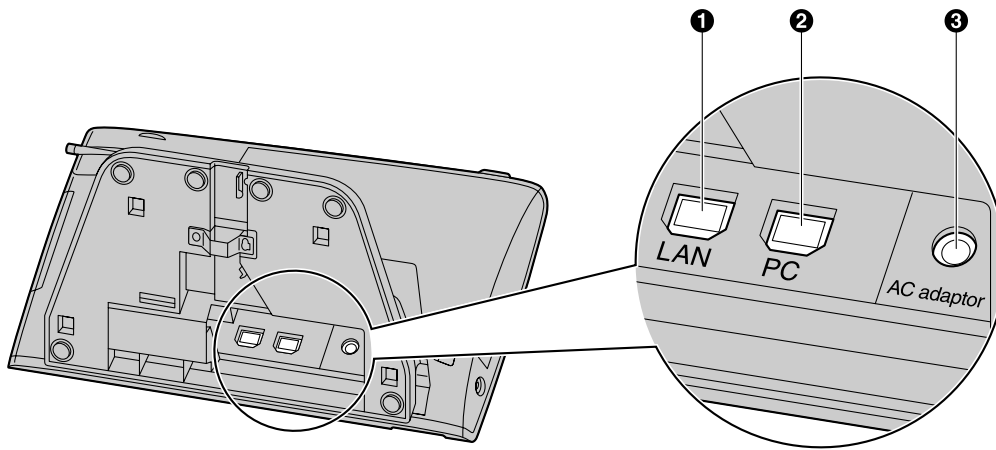

❶ LAN Port

❷ PC Port

❸ DC Jack

For details, see "Connections (Page 147)".

Operation Board Angle Adjustment

The angle of the operation board can be set to one of seven angles (level 1 = 30°, level 7 = 60°).

IMPORTANT

- When you use the KX-NT400 first time, before adjusting the angle of the operation board, press and hold the angle adjustment button, lift the operation board until you hear the lock click, and then release the button.

CAUTION

- Hold the operation board until it is secured at the desired angle.
- Make sure you do not pinch your fingers when raising or lowering the operation board.
- Do not squeeze the LCD touch screen when adjusting the operation board; applying too much pressure will damage the screen.

To raise:

1. Hold the base of the unit with one hand.
2. Gently lift the operation board one level at a time to the desired angle.

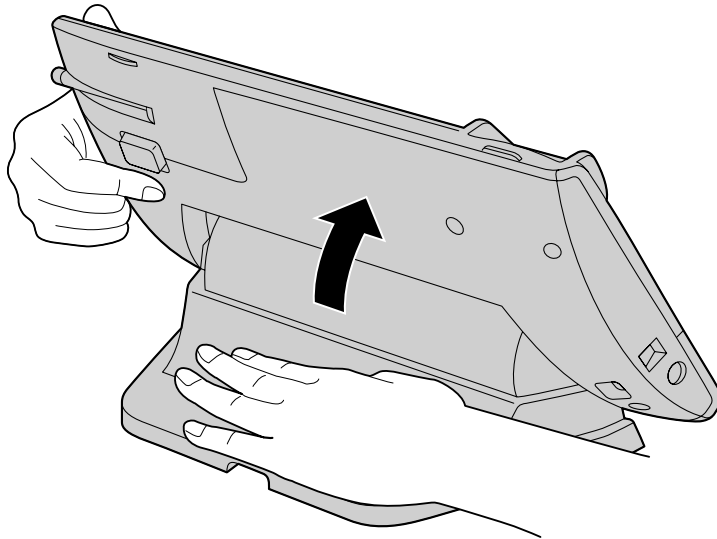

To lower:

1. Hold down the button as shown in the illustration below.
2. Hold the base of the unit with one hand.
3. Slightly lift the operation board to disengage the lock.

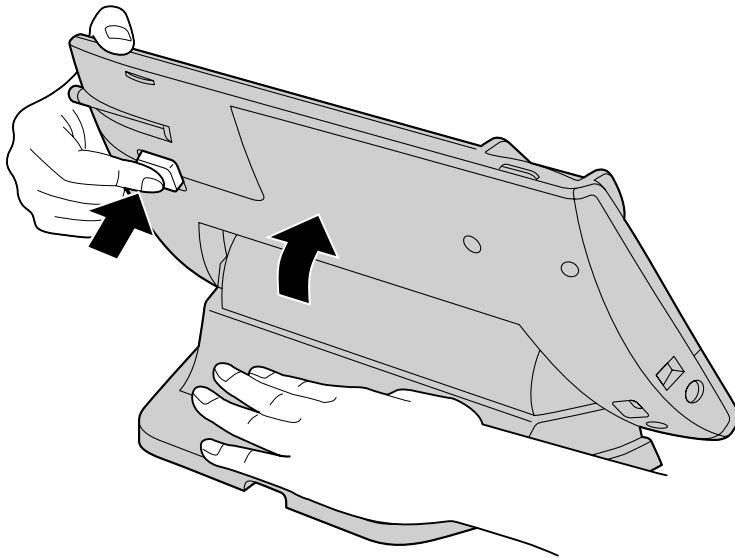

4. While holding down the button, tilt the board to the desired angle and then release the button.

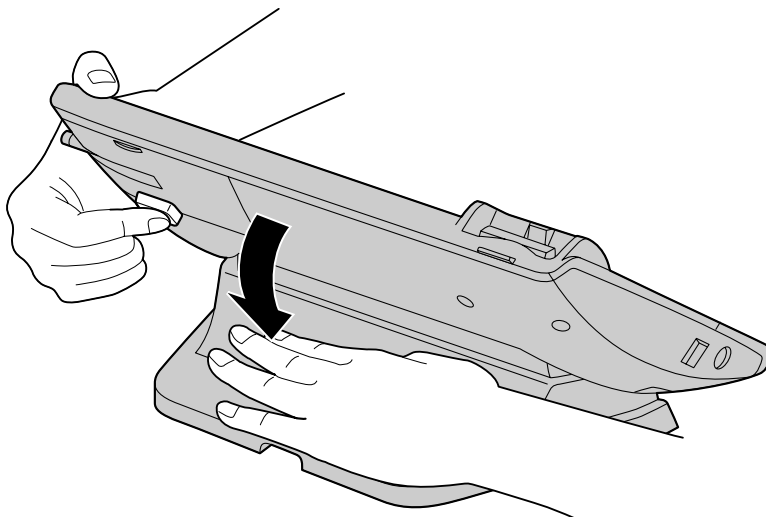

Hooking the Handset

You can hook the handset with following operations.

To Hook the Handset During a Conversation

1. Hook the handset over the top edge of the unit.

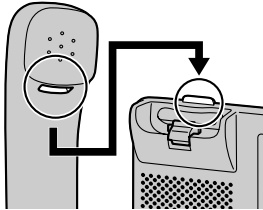

To Lock the Handset Hook when the KX-NT400 is Wall Mounted

1. Remove the handset hook from the slot.

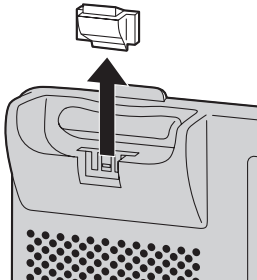

2. Turn it up-side-down.

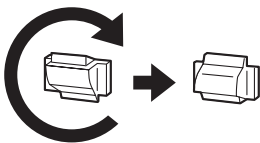

3. Slide the handset hook back into the slot until it locks.

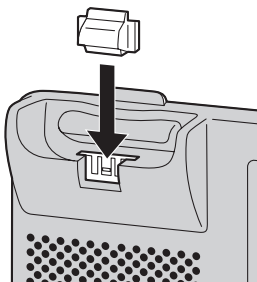

4. Handset is safely hooked when it is in the cradle.

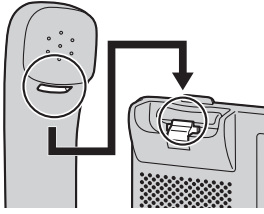

Screens & Soft Buttons

This section explains all of the buttons and icons that appear on each of the screens.





Navigation





You can navigate among the various screens on the KX-NT400 by using the tabs along the top screen.



Navigation details

1 Tabs and controls

Soft Button or Icon	Description
	Display the HOME screen (Page 29). If the Calls screen is set to Line Buttons mode (the default mode), an orange line appears on this tab when you have new missed calls.  <ul style="list-style-type: none"> • Checking Missed Calls (Page 78) • Calls Screen (Page 37)
	Display the Contacts screen (Page 32).
	Display the Calls screen (Page 37).
	Display the Call Log screen (Page 47).

Soft Button or Icon	Description
	Display the Camera screen (Page 49).
	Display the Chat screen (Page 52).
	Display the Portal screen (Page 54).
	Display the Options screen (Page 57).
	Display additional tabs.

HOME Screen

On the **HOME** screen, you can perform the following operations:

- Checking New Messages (Page 76)
- Checking Missed Calls (Page 78)
- Accessing Voice Mail (Page 77)
- Presence Status Setting (Page 78)
- Call Forwarding/Do Not Disturb (Page 79)
- Locking Operations (Application Lock) (Page 75)
- Auto answer (Page 67)
- Redialing the Last Number You Dialed (Redial, Last Number) (Page 66) (*Call List mode only*)
- Adjusting the Volume (Page 58)

The following screen shows the appearance of the **HOME** screen when the **Calls** screen is set to Line Buttons mode.



If the **Calls** screen is set to Call List mode, additional buttons are displayed on the **HOME** screen.

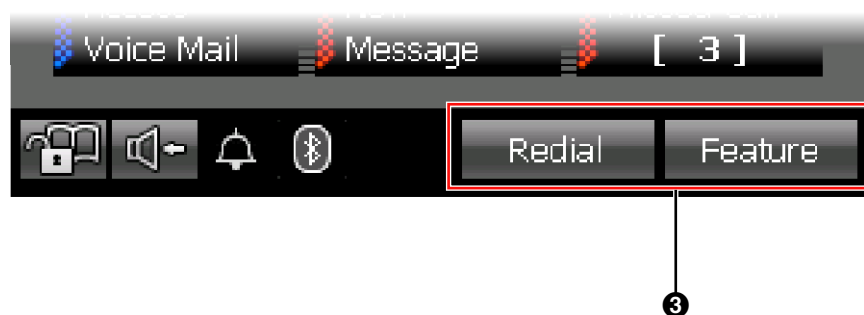







Note















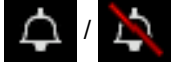

- For details about the **Calls** screen's modes, see "Calls Screen (Page 37)".

HOME Screen Details



1 Presence and messages

Soft Button or Icon	Description
	<p>Change your presence status.</p>  <ul style="list-style-type: none"> • Presence Status Setting (Page 78)
	<p>Change your Call Forwarding settings and Do Not Disturb (DND) settings.</p>  <ul style="list-style-type: none"> • Call Forwarding/Do Not Disturb (Page 79)
	<p>Access the Voice Mail service. This button appears if you have set the voice mail system's extension number.</p>  <ul style="list-style-type: none"> • Accessing Voice Mail (Page 77)
	<p>Check new messages. This button appears only when there is a new message.</p>  <ul style="list-style-type: none"> • Checking New Messages (Page 76)
	<p>Display the missed call log. This button appears only when there is a new missed call.</p>  <ul style="list-style-type: none"> • Checking Missed Calls (Page 78)
	<p>Displays the current time.</p> <p>Note If the Calls screen is set to Call List mode, the date is displayed beneath the clock. For details about the Calls screen, see "Calls Screen (Page 37)".</p>

2 Miscellaneous controls

Soft Button or Icon	Description
	<p>Lock/Unlock access to all screens except the HOME, Calls, and Feature Key screens.</p> <p>: Access to screens is locked.</p> <p>: Access to screens is unlocked.</p> <p></p> <ul style="list-style-type: none"> Locking Operations (Application Lock) (Page 75)
	<p>Turn on/off Auto Answer (receiving an incoming call in hands-free mode).</p> <p>: Auto Answer is turned on.</p> <p>: Auto Answer is turned off.</p> <p></p> <ul style="list-style-type: none"> Receiving a Call (Page 67)
	<p>Indicates the ringer status.</p> <p>: The ringer is turned on.</p> <p>: The ringer is turned off.</p> <p></p> <ul style="list-style-type: none"> Adjusting the Volume (Page 58)
	<p>Indicates the Bluetooth connection status.</p> <p>: Communicating with module</p> <p>: Linking</p> <p>: Talking/Playing the background music</p> <p>When a Bluetooth Module is not installed, these icons do not appear on the screen.</p> <p></p> <ul style="list-style-type: none"> Bluetooth Headset Connections (Page 153)

3 Buttons available in Call List mode

Soft Button or Icon	Description
	<p>Redial the last number you dialed.</p> <p></p> <ul style="list-style-type: none"> Redialing the Last Number You Dialed (Redial, Last Number) (Page 66)
	<p>Display the Feature Key screen (Page 55).</p>

Contacts Screen

On the **Contacts** screen, you can view and make calls to contacts in your local directory and contacts stored on an LDAP directory.

The following operations are available on this screen:

- Making a Call from the Contact List (Page 63)
- Starting a Chat Session (Page 83)
- Adding a New Contact (Page 108)
- Editing a Contact (Page 109)
- Deleting a Contact (Page 109)

Local Directory









LDAP Directory

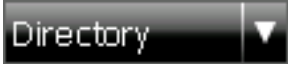





Contacts Screen Details

1 Local directory operations

Soft Button or Icon	Description
	<p>Select Directory to display the contacts stored in the local directory.</p> <p>To switch to the LDAP directory, press the directory selection list, and select LDAP Search.</p> <p></p> <ul style="list-style-type: none"> • Making a Call from the Local Directory (Page 63)
	<p>Add a new contact to your personal contacts.</p> <p></p> <ul style="list-style-type: none"> • Adding a New Contact (Page 108) • Adding a Contact from the PBX (Page 109)
	<p>Search the local directory for a contact.</p> <p></p> <ul style="list-style-type: none"> • Making a Call from the Local Directory (Page 63)







2 Contact list entries

Soft Button or Icon	Description
	<p>Shows the status of the contact's telephone. Also, you can make a call, start a chat, or edit the information about the contact.</p> <p></p> <ul style="list-style-type: none"> • Making a Call from the Local Directory (Page 63) • Chat (Page 83) • Telephone status icons (Page 33) • Details for Contacts (Page 109)
	<p>Scroll the list on the screen.</p>
	<p>Scroll to the top/bottom of the list on the screen.</p>



Telephone status icons







The icons for each directory entry indicate the status of each extension's telephone.

For extensions using KX-NT400

Icon	Phone Status	Presence Status (Absent Message)
	Idle	Presence status not set (Available)
		Presence status On or DND for internal call
	Busy	Presence status not set (Available)
		Presence status On or DND for internal call
	Ringing	Presence status not set (Available)
		Presence status On or DND for internal call

For extensions logged in to Communication Assistant (CA)







Icon	Phone Status	Absent Message
	Idle	Absent message not set (Available)
		Absent message On or DND for internal call
		Automatic absent message is set or DND for internal call

Icon	Phone Status	Absent Message
	Busy	Absent message not set (Available)
		Absent message On or DND for internal call
		Automatic absent message is set or DND for internal call
	Ringing	Absent message not set (Available)
		Absent message On or DND for internal call
		Automatic absent message is set or DND for internal call
No Icon	The line is not connected	





Note







- The status of CA users connected through CA Server is not displayed. For details, consult your administrator.

For other extensions







Icon	Phone Status	Absent Message
	Idle	Absent message not set (Available)
		Absent message On or DND for internal call
	Busy	Absent message not set (Available)
		Absent message On or DND for internal call
	Ringing	Absent message not set (Available)
		Absent message On or DND for internal call
No Icon	The line is not connected	

③ Contact summary information



Soft Button or Icon	Description
	<p>Display/hide the soft keyboard.</p> <p>: The soft keyboard is not displayed.</p> <p>: The soft keyboard is displayed.</p> <p></p> <ul style="list-style-type: none"> Using the Soft Keyboard (Page 60)

Soft Button or Icon	Description
	Switch the character table used for entering characters with the dial keys.  <ul style="list-style-type: none"> Entering Characters (Page 145)
	Shows information for the selected contact: <ul style="list-style-type: none"> Phone number Presence status
	Display the Dial window for pre-dialing.  <ul style="list-style-type: none"> Making a Call (Page 62)
	Disconnect the current call.

④ LDAP directory operations

Soft Button or Icon	Description
	Select LDAP Search to display a contact list stored in LDAP servers. To switch to the local directory, press the directory selection list, and select Directory .  <ul style="list-style-type: none"> Making a Call from the LDAP Directory (Page 64)
	Display the LDAP Server Select screen.
	Search the LDAP directory for a contact.  <ul style="list-style-type: none"> Making a Call from the LDAP Directory (Page 64)
	Display the Advanced screen, from which you can perform an advanced search.  <ul style="list-style-type: none"> Making a Call from the LDAP Directory (Page 64)

5 LDAP contact list entries

Soft Button or Icon	Description
	<p>Shows the contact's name and registered phone number. Also, you can make a call to and display detailed information for the selected contact.</p>  <ul style="list-style-type: none">• Making a Call from the LDAP Directory (Page 64)• Adding a Contact from an LDAP Directory (Page 109)

Calls Screen

When you start a conversation or you answer a call, the **Calls** screen appears.

On the **Calls** screen, you can use PBX call handling features.

There are 2 modes for operating the **Calls** screen:

- **Line Buttons Mode**
In this mode, the **Calls** screen is similar to a conventional IP proprietary telephone (IP-PT). This mode lets you easily access flexible keys, which you can customize freely. This is the default mode.
See "Calls Screen in Line Buttons Mode (Page 37)".
- **Call List Mode**
In this mode, your active calls are displayed in a list, and the available functions are displayed as buttons.
See "Calls Screen in Call List Mode (Page 40)".

For details about changing the mode, see "Display Settings (Page 113)".

Calls Screen in Line Buttons Mode

Line Buttons mode lets you easily access flexible keys. You can customize the flexible keys to access frequently used functions and destinations. For details, see "Customizing the Flexible Buttons (Page 133)".

Additionally, to use the Call Waiting Caller ID (Visual Caller ID) function, use Line Buttons mode.



Calls Screen in Line Buttons Mode Details

1 Soft buttons

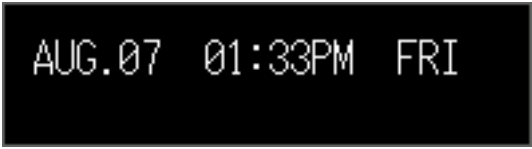

Soft Button or Icon	Description
	<p>Soft buttons. Use these buttons for feature key operations. The buttons change according to current operation.</p>

Soft Button or Icon	Description
	Sub-display. Displays messages related to the current operation.





② Feature key page selection





Soft Button or Icon	Description
	Change the feature key page.

③ Feature keys

Soft Button or Icon	Description
	You can customize the flexible buttons by assigning functions to them.  <ul style="list-style-type: none"> • Customizing the Flexible Buttons (Page 133)

④ Function buttons

Soft Button or Icon	Description
	Used to leave a message waiting indication or call back the party who left the message waiting indication. When you have a message waiting indication, this button's light blinks red.  <ul style="list-style-type: none"> • Checking Message Waiting (Page 76) • Leaving a Message Waiting Indication (Page 86)
	Used to make or receive intercom calls. When you have seized the intercom line, this button's light lights green.
	Used to mute the microphone during a conversation. When mute is active, this button's light blinks red.  <ul style="list-style-type: none"> • Mute (Page 72)

Soft Button or Icon	Description
	<p>Used to disconnect the current call and make another call without hanging up. You can also use this button to access external features, if any are available.</p>  <ul style="list-style-type: none">• Accessing External Services (External Feature Access [EFA]) (Page 88)
	<p>Used to redial the last outside phone number that you dialed.</p>  <ul style="list-style-type: none">• Redialing the Last Number You Dialed (Redial, Last Number) (Page 66)

Calls Screen in Call List Mode

Call List mode displays a list of all calls that you are currently handling. Call handling functions that are available for the currently selected call are displayed beneath the list. The buttons change depending on the status of the selected call.

Note

- To display the **Calls** screen in Call List mode, see "Display Settings (Page 113)".













Calls Screen in Call List Mode Details

1 Current call display

Soft Button or Icon	Description
	<p>Display information about the current calls. Each entry shows the following information:</p> <ul style="list-style-type: none"> For Outgoing Calls <ul style="list-style-type: none"> Call status icon The dialed number or name when available Duration of call For Incoming Calls <ul style="list-style-type: none"> Call status icon Number of the caller (up to 16 digits) or name when available Group name of the caller when available Duration of call <p> <ul style="list-style-type: none"> Call status icons (Page 41) During a Conversation (Page 69) </p>

Soft Button or Icon	Description
	Scroll the list on the screen.

Call status icons



Icon	Call Status
	Off-hook
	Outgoing call
	Incoming call
	Active call
	Call on hold
	Call in a conference call (Conference is established)
	Busy
	Do not disturb
	Parked call
	No valid call (Reorder tone is heard)



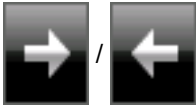

② Call operations

Note





- The buttons in area ② change according to the selected call. When there is no available operation for the selected call, no buttons are displayed.

Common



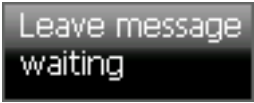

Soft Button or Icon	Description
	Display the next/previous page for available operations.
	Hang up the call.

Soft Button or Icon	Description
	<p>Mute/unmute outgoing voice and sound.</p> <p> : Outgoing voice and sound is muted.</p> <p> : Outgoing voice and sound is not muted.</p> <p></p> <ul style="list-style-type: none"> • Mute (Page 72)



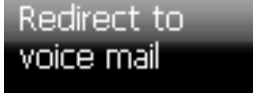

For outgoing calls



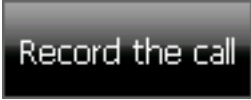

Soft Button or Icon	Description
	<p>Leave a notification that you called to the called extension. This button appears only for internal calls.</p> <p></p> <ul style="list-style-type: none"> • Leaving a Message Waiting Indication (Page 86)
	<p>Leave a message using the voice mail service. This button appears only for internal calls.</p> <p></p> <ul style="list-style-type: none"> • Leaving a Voice Message (Page 86)

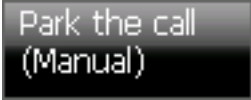
For incoming calls

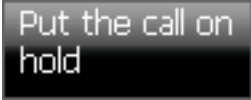

Soft Button or Icon	Description
	<p>Answer the selected call.</p>
	<p>Redirect the selected call to a preset extension.</p> <p></p> <ul style="list-style-type: none"> • Redirecting Calls (Page 68)
	<p>Redirect the selected call to your voice mailbox.</p> <p></p> <ul style="list-style-type: none"> • Redirecting Calls (Page 68)

For active calls





Soft Button or Icon	Description
	<p>Record the current call to voice mail. This feature requires a Panasonic Voice Processing System.</p>  <ul style="list-style-type: none"> Recording Calls (Two-way Recording) (Page 72)
	<p>Stop recording the current call.</p>  <ul style="list-style-type: none"> Recording Calls (Two-way Recording) (Page 72)
	<p>Invite a third party and establish a conference call.</p>  <ul style="list-style-type: none"> Conference Call (Multiple Party Conversation) (Page 73)
	<p>Park the call in an idle parking zone.</p>  <ul style="list-style-type: none"> Holding a Call in a System Parking Zone (Call Park) (Page 70)
	<p>Park the call in a specified parking zone.</p>  <ul style="list-style-type: none"> Holding a Call in a System Parking Zone (Call Park) (Page 70)
	<p>Transfer the call.</p>  <ul style="list-style-type: none"> Transferring a Call (Call Transfer) (Page 71)
	<p>Transfer the call to an extension's voice mail.</p>  <ul style="list-style-type: none"> Transferring a Call (Call Transfer) (Page 71)
	<p>Put the call on hold.</p>  <ul style="list-style-type: none"> Holding a call at your extension (Call Hold) (Page 69)

Soft Button or Icon	Description
	<p>Use External Feature Access (EFA) to access special features offered by a host PBX or a telephone company.</p>  <ul style="list-style-type: none"> • Accessing External Services (External Feature Access [EFA]) (Page 88)
	<p>Switch the call on hold and the current call.</p>  <ul style="list-style-type: none"> • Talking to Two Parties Alternately (Call Splitting) (Page 71)









For calls on hold

Soft Button or Icon	Description
	<p>Retrieve the selected call on hold.</p>  <ul style="list-style-type: none"> • Holding a Call (Page 69)

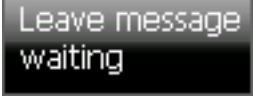

For calls in a conference call

Soft Button or Icon	Description
	<p>Invite a third party and establish a conference call.</p>  <ul style="list-style-type: none"> • Making a Conference Call (Page 73)
	<p>Remove the selected participant from the conference.</p>  <ul style="list-style-type: none"> • Removing a Participant from the Conference (Page 74)



For busy calls

Soft Button or Icon	Description
	<p>You can receive a callback ringing notification from an extension when it becomes available. This button appears only for internal calls.</p>  <ul style="list-style-type: none"> Reserving a Busy Line (Automatic Callback Busy) (Page 87)
	<p>Send the called extension a call waiting signal. This button appears only for internal calls.</p>  <ul style="list-style-type: none"> Sending a Call Waiting Notification (Call Waiting) (Page 86)
	<p>Leave a notification that you called at the called extension. This button appears only for internal calls.</p>  <ul style="list-style-type: none"> Leaving a Message Waiting Indication (Page 86)
	<p>Override the selected call. The call will shift to conference mode. This button appears only for internal calls.</p>  <ul style="list-style-type: none"> Joining an Existing Conversation (Executive Busy Override) (Page 87)

For Do Not Disturb calls

Soft Button or Icon	Description
	<p>Override Do Not Disturb.</p>  <ul style="list-style-type: none"> Overriding Do Not Disturb (DND Override) (Page 87)

For parked calls

Soft Button or Icon	Description
 A rectangular button with a dark gradient background and the text "Unpark the call" in white.	Retrieve the selected parked call.  <ul style="list-style-type: none">• Holding a Call in a System Parking Zone (Call Park) (Page 70)

Call Log Screen

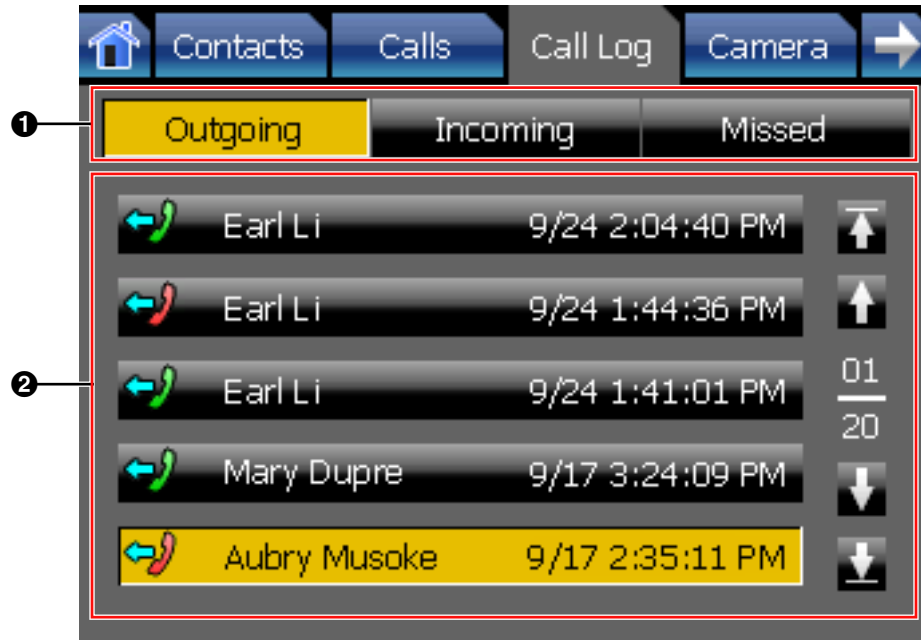

On the **Call Log** screen, you can view a list of your outgoing, incoming, and missed calls. The following operations are available on this screen:

- Dialing by Using Call Logs (Page 65)
- Adding a Contact from a Call Log (Page 108)







Call Log Screen Details



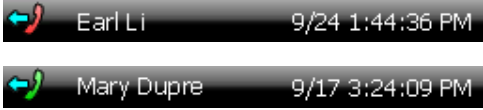



1 Call log selection

Soft Button or Icon	Description
	Display the Outgoing call log.
	Display the Incoming call log.
	Display the Missed call log.

2 Call log entries

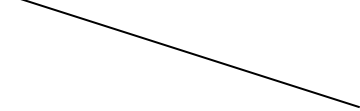
Soft Button or Icon	Description
	<p>Display the status icon, caller's name, and timestamp of the call. You can make a call, add the party to the local directory, display the caller's picture, and display detailed information.</p> <p></p> <ul style="list-style-type: none"> • Call log icons (Page 48) • Dialing by Using Call Logs (Page 65) • Adding a Contact from a Call Log (Page 108)
	<p>Scroll the log list on the screen.</p>
	<p>Scroll to the top/bottom of the log list on the screen.</p>

Call log icons

Icon		
Outgoing	Incoming	Missed
 Outgoing Answered Call	 Incoming Received Call	
 Outgoing Unanswered Call	 Incoming Missed Call	 Incoming Missed Call

Camera Screen



On the **Camera** screen, you can perform operations related to cameras.

- Network Camera (Page 81)





Camera Screen Details















1 Camera display









Soft Button or Icon	Description
	<p>Shows the selected camera's video feed.</p> <p></p> <ul style="list-style-type: none"> • Adjusting the Angle of the Camera (Page 82)

2 Camera selection buttons

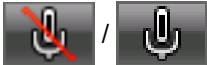
Soft Button or Icon	Description
	<p>Quick-access button for registered cameras. The name you registered for the camera is displayed on the button (e.g., "Back Door", "Front").</p> <p></p> <ul style="list-style-type: none"> • Selecting Cameras to View (Page 81) • IP Camera Settings (Page 116)

3 Camera operation

Soft Button or Icon	Description
	<p>Select a camera to display.</p> <p></p> <ul style="list-style-type: none"> • Selecting Cameras to View (Page 81) • IP Camera Settings (Page 116)
	<p>Choose a preset viewing angle for the selected camera.</p> <p></p> <ul style="list-style-type: none"> • Adjusting the Angle of the Camera (Page 82)
	<p>Zoom in the view.</p> <p></p> <ul style="list-style-type: none"> • Zooming In and Out (Page 81)
	<p>Zoom out the view.</p> <p></p> <ul style="list-style-type: none"> • Zooming In and Out (Page 81)
	<p>Show/hide the pan and tilt buttons on the camera view.</p> <p></p> <ul style="list-style-type: none"> • Adjusting the Angle of the Camera (Page 82)
	<p>Switch to full-screen mode.</p> <p></p> <ul style="list-style-type: none"> • Full-Screen Mode (Page 82)
	<p>Pan-scan the view.</p> <p></p> <ul style="list-style-type: none"> • Adjusting the Angle of the Camera (Page 82)

Soft Button or Icon	Description
	<p>Tilt-scan the view.</p>  <ul style="list-style-type: none"> Adjusting the Angle of the Camera (Page 82)
	<p>Mute/unmute outgoing voice and sound from the KX-NT400.</p>  : Outgoing voice and sound is muted.  : Outgoing voice and sound is not muted.  <ul style="list-style-type: none"> Mute (Page 72)
	<p>During a conversation with a doorphone, open the door connected to a doorphone camera.</p>  <ul style="list-style-type: none"> Opening Doors (Page 82)

^{*1} Depending on the camera model, this operation might not be available, or it might not function due to security settings, etc.

Chat Screen

On the **Chat** screen, you can participate in a chat session with another KX-NT400 user or Communication Assistant user. You can start a chat session by selecting a contact on the **Contacts** screen.

The following operations are available on this screen:

- Chat (Page 83)
- Making a Call to a Chat Participant (Page 83)

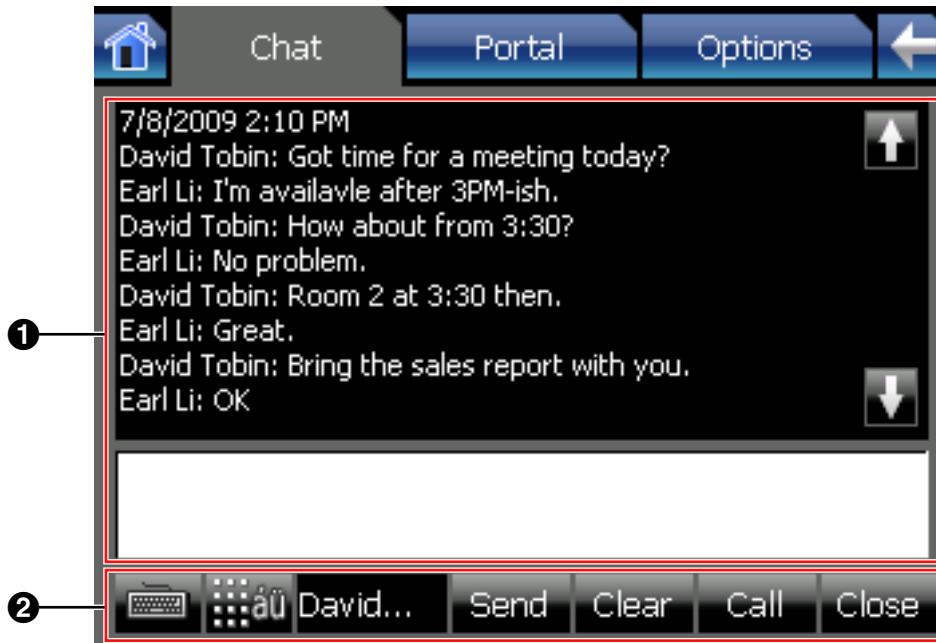









Chat Screen Details

1 Chat area

Soft Button or Icon	Description
	Scroll the chat log on the screen.

2 Chat controls

Soft Button or Icon	Description
	Display/hide the soft keyboard.  : The soft keyboard is not displayed.  : The soft keyboard is displayed.
	<ul style="list-style-type: none"> • Using the Soft Keyboard (Page 60)
	Shows the name or the extension number of the other chat participant.

Soft Button or Icon	Description
	Send the message you typed in the message input box.
	Clear the text in the message input box.
	Make a call to the other chat participant.
	End the chat. The other chat participant will be disconnected.

Portal Screen









On the **Portal** screen, you can browse Web pages on your organization's intranet.

- Portal (Web Browser) (Page 84)



Portal Screen Details

1 Portal screen controls

Soft Button or Icon	Description
	Select an intranet Web page from the Web page list.  <ul style="list-style-type: none"> • Selecting a URL to Access (Page 84)
	Display your homepage.  <ul style="list-style-type: none"> • Going Back to Your Homepage (Page 84)
	Display/hide the soft keyboard.  : The soft keyboard is not displayed.  : The soft keyboard is displayed.  <ul style="list-style-type: none"> • Using the Soft Keyboard (Page 60)

Feature Key Screen

If the **Calls** screen is set to Call List mode, you can use the **Feature Key** screen to perform operations in the same way as on a Proprietary Display Telephone. You can access PBX features that are unavailable elsewhere on the KX-NT400.

You can assign phone numbers and PBX features to the flexible keys for easy access. See the following section for details:

- Customizing the Flexible Buttons (Page 133)

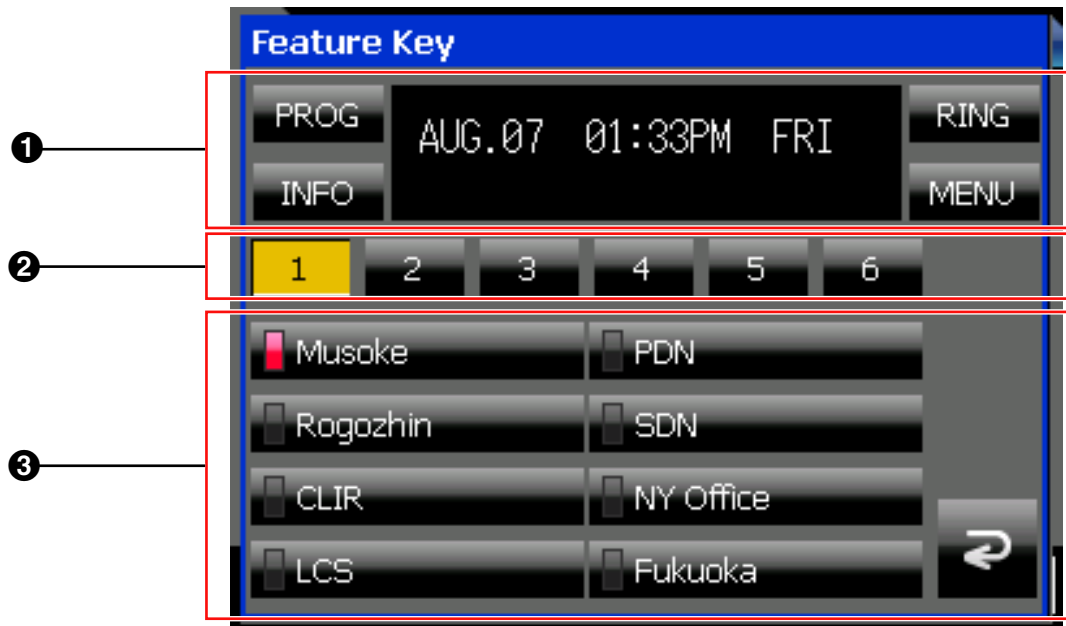

Note

- The **Feature Key** screen is accessed by pressing **Feature** on the **HOME** screen. For details about the **HOME** screen, see "HOME Screen (Page 29)".
- If the **Calls** screen is set to Line Buttons mode, you cannot access this screen. All of the functions available on this screen can be performed on the **Calls** screen. For details, see "Calls Screen in Line Buttons Mode (Page 37)".

Feature Key Screen Details





① Soft buttons

Soft Button or Icon	Description
	Soft buttons. Use these buttons for feature key operations. The buttons change according to current operation.
	Sub-display. Displays messages related to the current operation.

2 Feature key page selection

Soft Button or Icon	Description
	Change the feature key page.

3 Feature keys

Soft Button or Icon	Description
	<p>You can customize the flexible buttons by assigning functions to them.</p> <p></p> <ul style="list-style-type: none"> • Customizing the Flexible Buttons (Page 133)
	<p>Return to the HOME screen.</p> <p></p> <ul style="list-style-type: none"> • HOME Screen (Page 29)

Options Screen

From the **Options** screen, you can access various settings for the KX-NT400.

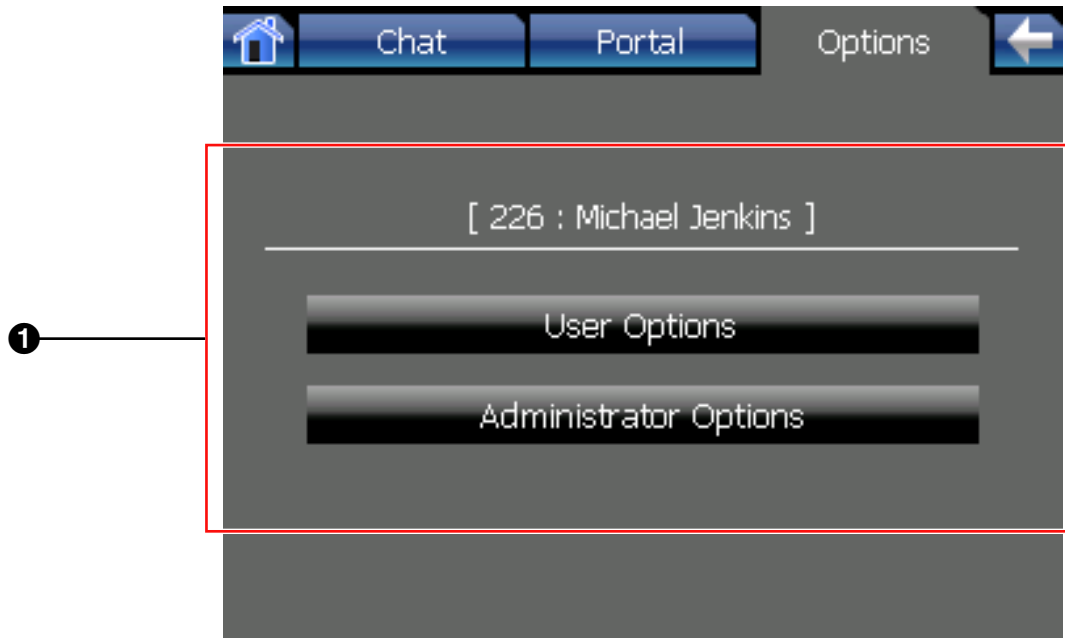

The following operations are available on this screen:

- User Options (Page 113)
- Administrator Options (Page 121)



Options Screen Details

1 Options screen details

Soft Button or Icon	Description
[226 : Michael Jenkins]	Shows the extension number and name registered for your extension.
User Options	Display the User Options screen.  <ul style="list-style-type: none"> • User Options (Page 113)
Administrator Options	Display the Administrator Options screen.  <ul style="list-style-type: none"> • Administrator Options (Page 121)

Basic Operations

This section explains the basics of using the KX-NT400.

Confirming Your Extension Number

You can view the extension number and name registered to the KX-NT400 on the **Options** screen.

- To display the **Options** screen, press the **Options** tab.

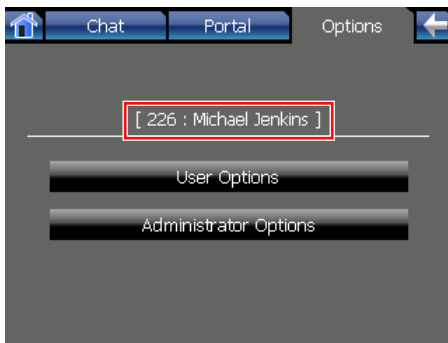

For details about the **Options** screen, see "Options Screen (Page 57)".

Going off- and on-hook

With the KX-NT400 there are several ways to go off-hook and on-hook:

- Using the handset
- Using the  (**SP-PHONE**) button
- Using on-screen controls

Going off-hook

In this manual, when you see the phrase "go off-hook", you can do any of the following:

- Lift the handset off of its cradle.
- Press  (**SP-PHONE**) while the handset is on its cradle. This enables hands-free mode.

!! Usage tips

- Certain on-screen buttons, such as the **Answer** button on the **Call Alert** window, function like the  (**SP-PHONE**) button.

Going on-hook

In this manual, when you see the phrase "go on-hook", you can do any of the following:

- Replace the handset on its cradle.
- If you are in hands-free mode, press  (**SP-PHONE**).

!! Usage tips



- Certain on-screen buttons, such as the **Hang up** button on the **Calls** screen (in Call List mode), perform the same function as going on-hook.

Hands-free Mode

In hands-free mode, you can talk and hear the other party in a conversation without using the handset. This mode is useful for performing other tasks during a conversation, such as writing.

Enabling hands-free mode

You can enable hands-free mode in one of the following ways:

- In stand-by mode (i.e., when you have no active calls), press  (**SP-PHONE**).
- During a conversation while using the handset, press  (**SP-PHONE**), and return the handset to its cradle.
- Certain on-screen buttons, such as the **Answer** button on the **Calls** screen (in Call List mode), activate hands-free mode as well. These buttons appear only when you have an incoming call.

Canceling hands-free mode

You can cancel hands-free operation simply by lifting the handset off its cradle.

Adjusting the Volume

You can adjust the ringer, handset, and speaker volume using Δ (**UP**) and ∇ (**DOWN**) on the Navigator key.

Adjusting the ringer volume

In stand-by mode (i.e., when you do not have any active calls), press Δ (**UP**) and ∇ (**DOWN**) on the Navigator key.

!! Usage tips

- When the ringer volume is turned all the way down,  is displayed on the **HOME** screen. For details, see "HOME Screen (Page 29)".

Adjusting the handset/headset/speaker volume

Press Δ (**UP**) and ∇ (**DOWN**) on the Navigator key during a conversation when using the handset, a headset, or when you are in hands-free mode.

Basic Screen Operations

This section explains the basic operations for using the screen.

Selecting Items

On screens such as the **Contacts** screen or **Call Log** screen, you can select items using the stylus pen or the Navigator key.

In this manual, when you see a phrase such as "Select the item" or "Press the contact", you can do either of the following:

- Press the item on-screen using the stylus pen.
- Press Δ (**UP**) and ∇ (**DOWN**) on the Navigator key to highlight the desired item, and then pressing  (**ENTER**).

Some items, such as call control buttons, can only be operated using the stylus pen. If you cannot select an item using the Navigator key, use the stylus pen to select it instead.

!! Usage tips

- Highlighted items are displayed with a yellow background:



- Some operations require you to use the Navigator key to highlight an item before performing an action on it. In this manual, when you must use the Navigator key to perform an operation, it will be

explicitly written. For example, "Use the Navigator key to highlight ...".



Scrolling Pages

If there is more information than can be displayed on 1 screen, you can scroll the screen. The arrow buttons and an indicator of the current and total number of pages are displayed on the right side of the screen.



You can scroll through the pages by pressing the arrows.

The arrows have the following meanings:

	Scroll to the previous or following page, respectively.
	Scroll to the first or last page in the list, respectively.

Other Common Screen Operations

The following common operations can also be performed using either the on-screen controls or the hardware buttons.

On screens that have an OK button

The following actions are equivalent:

- Pressing **OK** with the stylus pen.

- Pressing  (ENTER).

On screens that have a Cancel button

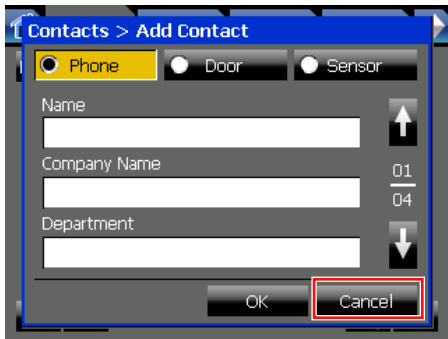

- The following actions are equivalent:
- Pressing **Cancel** with the stylus pen.
 - Pressing  (CANCEL).

Entering Text

There are 3 ways to input text:

- Using the Soft Keyboard (Page 60)
- Using a USB Keyboard (Page 61)
- Using the Dial Keys (Page 61)

!! Usage tips

- You can select text by dragging over it with the stylus pen.

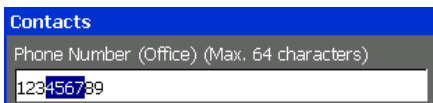

After you have selected text, the following operations are available (with the keyboard operation shown in brackets):

- Copy (Ctrl + C)
- Cut (Ctrl + X)
- Paste (Ctrl + V)

Using the Soft Keyboard

When you press a text field on the screen, a window containing the soft keyboard appears.

Window with soft keyboard

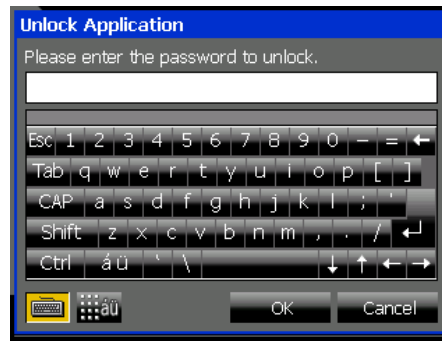

You can enter text by pressing the keys on the screen. When you are finished entering text, press **OK** on the bottom of the window.

Press **Cancel** to close the soft keyboard window without changing the original contents of the text field.

!! Usage tips

- Some screens, such as the **Contacts** and **Chat** screens, contain a soft keyboard button:



Press  to display and hide the soft keyboard.

- To use the Shift key, press **Shift** once, and then press the desired key. The keys will then return to their original characters. You do not need to hold **Shift** down while pressing a key as you do on a normal keyboard.

The Ctrl key can be used in the same manner.

- To enter accented characters, press  on the soft keyboard:



- If you are using the dial keys to enter text, pressing  switches the character table and allows you to enter additional characters. For details about character tables, see "Entering Characters (Page 145)".

Note

- The language for the soft keyboard depends on the display language selected for the KX-NT400. For details, see "Language Settings (Page 115)".

Using a USB Keyboard

If you connect a compatible USB keyboard^{*1} to the KX-NT400, you can enter text with the USB keyboard instead of the soft keyboard.

You can connect the keyboard at any time.

*1 User supplied.

Note

- The USB port is located on the right side of the KX-NT400. See "Right Side View (Page 19)".
- For details about connecting a USB key board, see "Connections for a USB Device (Page 149)".

Using the Dial Keys

You can use the dial keys to enter text as well as numbers. See "Entering Characters (Page 145)".

Basic Feature Operation

Making Calls



This section explains the basic methods for making a call.

Making a Call

1. In stand-by mode (i.e., when you have no active calls), go off-hook.
2. Enter the number you want to call.
The number you are dialing is displayed in the **Dial** window. When you finish dialing, the call will be connected.
3. To end the call, go on-hook.

Pre-dialing

In stand-by mode (i.e., when you have no active calls), you can start dialing while still on-hook. The **Dial** window will appear.

- To delete a number you entered, press \triangleleft (**LEFT**).
- To clear the entire number, press  (**TRANSFER**) or  (**HOLD**).
- To connect the call, go off-hook or press .

Quick Dialing

If a number has been programmed in the PBX as a Quick Dial number, you can dial that number by going off-hook and entering the programmed number. For details, consult your administrator.

Hot Line

You can configure the phone to automatically dial a number immediately when you go off-hook. See "Hot Line (Page 100)".

Operator Call

You can call an extension or a group assigned as the operator. See "Operator Call (Page 102)".

!! Usage tips

- After you dial, the **Calls** screen appears. For details, see "Calls Screen (Page 37)".

Note

- If you want to dial a phone number on the **Contacts** screen using the dial keys, press



and then enter the phone number. When you finish dialing, go off-hook or press



to connect the call.

Calling an Outside Party

You have to seize a CO line before dialing an outside phone number. The KX-NT400 can seize a CO line automatically for certain calls.

Automatic seizing

The KX-NT400 can seize a CO line automatically when a call is made with one of the following operations:

- Pre-dialing (Page 62)
- Making a Call from the Contact List (Page 63)
- Dialing by Using Call Logs (Page 65)
- Redialing the Last Number You Dialed (Redial, Last Number) (Page 66)
- One-touch Dialing (Page 66)
- Making Calls from the Portal (Page 84)

Manual seizing

You have to seize a CO line manually when you directly enter a phone number with dial keys.

1. Go off-hook.
2. Press  or an L-CO button.
An idle CO line will be seized.
3. Enter a phone number with dial keys.

Note

- You can create an L-CO button on the KX-NT400. For details, see "Customizing the Flexible Buttons (Page 133)".

!! Usage tips

- To seize a specific CO line, in step 2 press the corresponding CO button on the **Calls** screen or on the **Feature Key** screen (in Call List mode). For details about these screens, see "Calls Screen in Line Buttons Mode (Page 37)" and "Feature Key Screen (Page 55)".
- To select an idle CO line in a specific CO line group automatically, press a G-CO button, or press  and the CO line group number.
For details about creating a G-CO button, see "Customizing the Flexible Buttons (Page 133)".

Making a Call from the Contact List

The KX-NT400 provides the following 2 types of contact lists:

- **Local Directory**
The local directory contains the following types of contacts:
 - Your personal contacts
 - System speed dialing directory contacts
 - Extension number directory contacts
 For details about adding personal contacts, see "Contact List (Page 108)".
- **LDAP Directory**
If you have configured the settings for an LDAP server, you can view the contacts stored on that server.
For details about configuring LDAP server settings, see "LDAP Server Settings (Page 121)".

Note

- When you display the **Contacts** tab, the previously selected directory is displayed. The first time you display the **Contacts** tab, the local directory is displayed.

Making a Call from the Local Directory

1. Press the **Contacts** tab.
2. If necessary, press the directory selection list and select **Directory**.



3. To search for a contact, start entering the contact's name. For details about entering characters, see "Entering Text (Page 60)".

Note

- The contact list is searched in real time.

- The characters you enter are displayed in
- You can enter up to 3 characters to search for.
- You can delete a character by pressing < (LEFT) on the Navigator key.

4. Select the contact you want to call.
A window with a list of available destinations appears.
5. Select the desired destination and go off-hook.

Destination selection for a personal contact

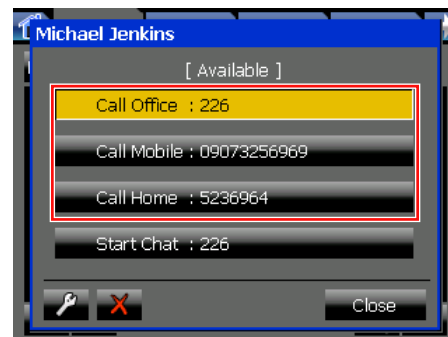

Destination selection for a contact from the system speed dialing directory or extension directory

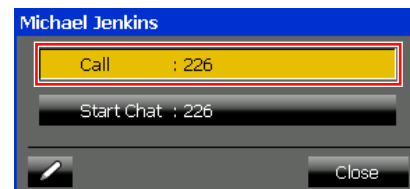

Note

- You can start a chat session by pressing **Start Chat**. For details, see "Chat (Page 83)".

6. To end the call, go on-hook.

!! Usage tips

- If you select a contact and then go off-hook, the contact will be dialed immediately. The first number registered, in the order of office → mobile → home, is dialed.
- You can add new contacts, and contacts from the system speed dialing directory and extension directory. For details, see "Contact List (Page 108)".

- The icons displayed next to contacts (such as ) indicate the contacts' status. For details, see "Telephone status icons (Page 33)".
- The following information about the selected contact is shown at the bottom of the **Contacts** screen:



- "404": Phone number
- "Available": Presence status (The presence status is only displayed if the information can be provided by the PBX.)

For details about presence status, see "Presence Status Setting (Page 78)".

- For details about the icons and buttons on the **Contacts** screen, see "Contacts Screen (Page 32)".

Note

- You cannot search directories that are not displayed. To display/hide directories, see "Directory List Select Settings (Page 115)".

Making a Call from the LDAP Directory

- Press the **Contacts** tab.
- If necessary, press the directory selection list and select **LDAP Search**.

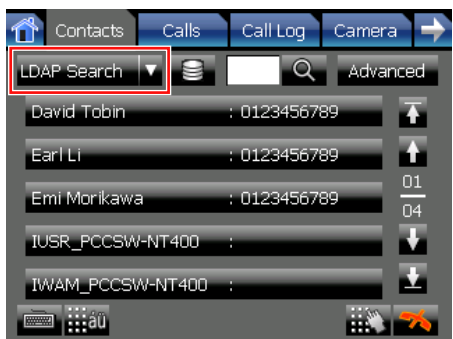

- To search for a contact, start entering the contact's name. For details about entering characters, see "Entering Text (Page 60)".

Note

- The characters you enter are displayed in .
- You can enter up to 32 characters to search for.

- You can delete a character by pressing **< (LEFT)** on the Navigator key.

- Press  to display contacts that match the search criteria.
- Select the contact you want to call. A window with a list of available destinations appears.
- Press **Call** and go off-hook.



- To end the call, go on-hook.

Advanced search

You can do an advanced search of the LDAP directory. In an advanced search, you can search by criteria such as first name, last name, and company. This feature is available only when the KX-NT400 is idle.

- On the **Contacts** screen, make sure the LDAP directory is displayed.
- Press **Advanced**.



- Enter the terms you want to search for, and then press **Search**.

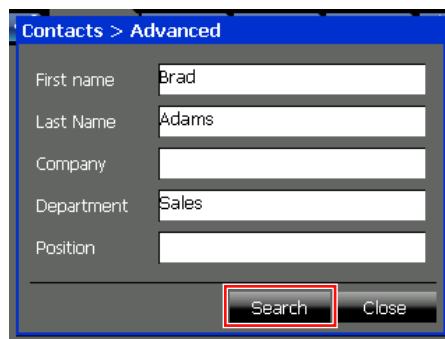

Contacts that contain all of the search terms are displayed.

!! Usage tips

- If you select a contact and then go off-hook, the contact will be dialed immediately.

- You can add a contact in the LDAP directory to your personal contacts. For details, see "Contact List (Page 108)".
- When you select a contact in the LDAP directory, you can display detailed information (such as the contact's name, phone numbers, e-mail address, etc.) by pressing **Show Details**. You can use the buttons at the bottom of the window to call the contact's office, mobile, or home phone if they are registered.



- Press  to select a different LDAP server. For details about specifying LDAP server information, see "LDAP Server Settings (Page 121)".
- For details about the icons and buttons on the **Contacts** screen, see "Contacts Screen (Page 32)".

Dialing by Using Call Logs

The last 100 incoming calls, outgoing calls, and missed calls are stored in their respective logs, in order of newest to oldest call.

You can make calls to the contacts/numbers listed in the call logs.

- Press the **Call Log** tab.
- Select a log by pressing **Outgoing**, **Incoming**, or **Missed**.

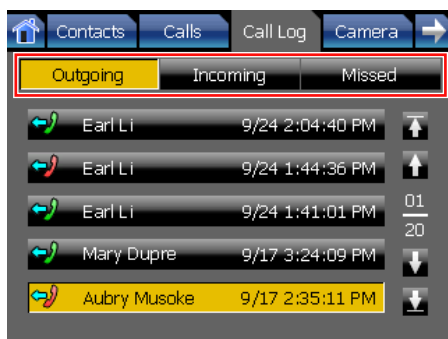

Note

- If you select a contact and then go off-hook, the contact will be dialed immediately.

- Select the desired entry. Detailed information for the selected entry will appear.
- Press **Call**.

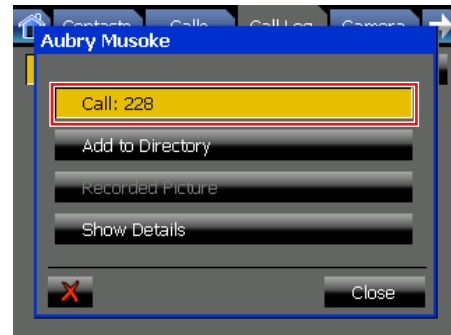

Note

- If you go off-hook while **Call** is selected, the contact will be dialed immediately.

- To end the call, go on-hook.

!! Usage tips

- For details about the buttons and icons on the **Call Log** screen, see "Call Log Screen (Page 47)".
- On the detailed information screen, the following actions are also available:
 - Add to Directory:** Add the information from the call log to your personal directory. See "Adding a Contact from a Call Log (Page 108)".
 - Recorded Picture:** When you receive a call from a destination with an integrated camera, a picture is taken and stored in the call log. Press this button to view the picture.
 - Show Details:** Display a screen with additional details about the call, such as the time the call started and ended, and the duration.
 - : Delete the call log.

Note

- If you have new missed calls, displaying the **Missed** call log clears the **Missed Call** button from the **HOME** screen. See "HOME Screen (Page 29)".

Redialing the Last Number You Dialed (Redial, Last Number)

Operation in Line Buttons mode

You can redial the last outside phone number that you dialed.

1. On the **Calls** screen, press **REDIAL**, and go off-hook.



2. To end the call, go on-hook.

Operation in Call List mode

You can redial the last number that you dialed. This operation redials both extension numbers and outside phone numbers.

1. On the **HOME** screen, press **Redial**, and go off-hook.

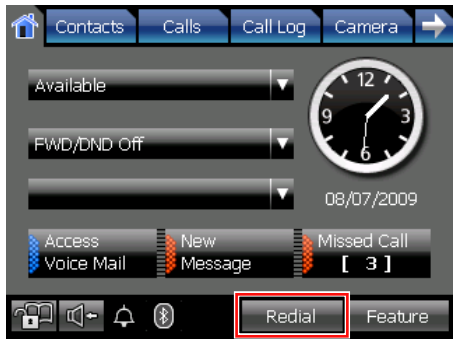

2. To end the call, go on-hook.

!! Usage tips

- Pressing the Redial button on your Bluetooth headset redials the last outside phone number you dialed. To enable this feature, consult your administrator.

Note

- Up to 32 digits can be stored and redialed.

One-touch Dialing

You can make a call with One-touch operation if you have created a One-touch dialing button for the desired party.

Operation in Line Buttons mode

1. On the **Calls** screen, select the list number of the desired party from the buttons 1–6.



2. Select the desired party and go off-hook.
3. To end the call, go on-hook.

Operation in Call List mode

1. Press **Feature** on the **HOME** screen.



- Select the list number of the desired party from the buttons 1–6.

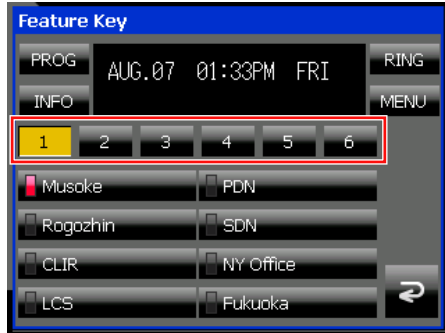

- Select the desired party and go off-hook.
- To end the call, go on-hook.

!! Usage tips

- For details about creating One-touch dialing buttons, see "Customizing the Flexible Buttons (Page 133)".

Receiving Calls

This section explains the basic methods for receiving a call.

Receiving a Call

When you have an incoming call, the **Call Alert** window appears.

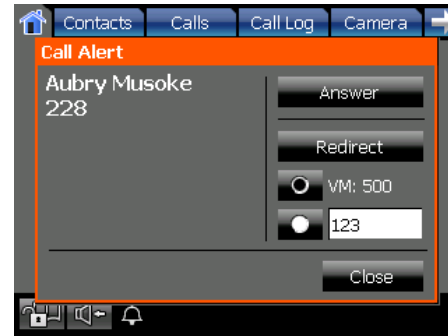



If you are viewing the **Camera** screen when an incoming call arrives, the **Call Alert** window appears along the bottom of the screen.



- Go off-hook, or, on the **Call Alert** window, press **Answer**.
- To end the call, go on-hook.

Auto answer

You can have the KX-NT400 automatically answer an incoming call.

- To enable Auto Answer: On the **HOME** screen, press .
- To disable Auto Answer: On the **HOME** screen, press .

Note

- For intercom calls, the call is connected without the KX-NT400 ringing.
- For outside calls, the call is connected after a programmed number of rings.

!! Usage tips

- After you answer a call, the **Calls** screen appears. For details, see "Calls Screen (Page 37)".

- You can redirect incoming calls to another telephone number or your voice mailbox. See "Redirecting Calls (Page 68)".
- If you press **Close** on the **Call Alert** window, the window will close, but the call will continue ringing.
- When you receive another call while the **Call Alert** window is displayed, the following window appears:

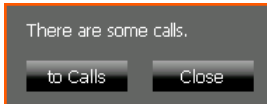

- **to Calls:** Display the **Calls** screen.
- **Close:** Close the window.

Note

- For incoming calls from CO lines, the KX-NT400 can display up to 16 digits of the caller's phone number.

Redirecting Calls

You can redirect incoming calls to another destination (extension or outside party), or to your mailbox. If you are on a call when you redirect a new incoming call, the incoming call will be redirected and your current call will continue uninterrupted.

To redirect the call on the Call Alert window

You can redirect a call directly from the **Call Alert** window, which appears when a call arrives.

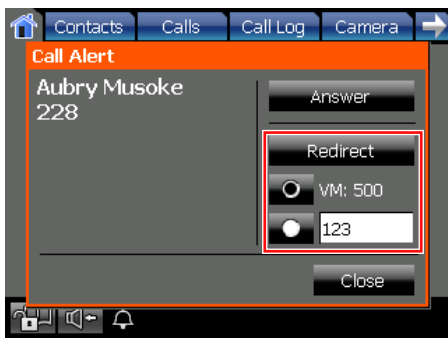

1. Select one of the following options to redirect the call:
 - **VM:**
Redirect the call to your mailbox.
 - **XXX**
Redirect the call to the number indicated by "XXX". Press the text box to enter the number to redirect the call to.
2. Press **Redirect**.

Note

- To redirect a call to your mailbox, you must set the voice mail system's extension number. You can also set a number that appears as the default redirect destination. For details, see "Dial Number Settings (Page 114)".

To redirect the call on the Calls screen (Call List mode only)

If you close the **Call Alert** window without answering the call, you can still redirect the call from the **Calls** screen (in Call List mode).

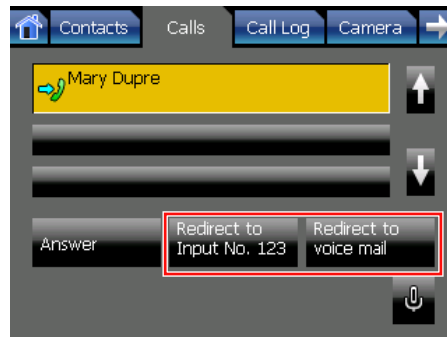

1. Press the **Calls** tab.
2. Select the incoming call.
3. Press one of the following buttons:
 - **Redirect to Input No. 123**
Redirect the call to the indicated number, "123" in this case.
 - **Redirect to voice mail**
Redirect the call to your mailbox.

Note

- To redirect a call, you must set the redirect destination and/or the voice mail system's extension number. For details, see "Dial Number Settings (Page 114)".
- If the **Calls** screen is set to Line Buttons mode, incoming calls cannot be redirected from the **Calls** screen. For details about Line Buttons mode, see "Calls Screen in Line Buttons Mode (Page 37)".

!! Usage tips

- You can configure the KX-NT400 to redirect all incoming calls to a specified destination. For details, see "Call Forwarding/Do Not Disturb (Page 79)".

During a Conversation

When you start a conversation, the **Calls** screen appears.

Calls screen in Line Buttons mode



Calls screen in Call List mode

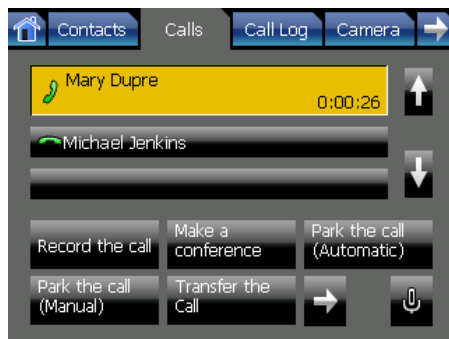

This section explains how to perform the following operations from the **Calls** screen:

- Put a call on hold or park a call (page 69)
- Receive a second call (page 70)
- Alternate speaking between 2 calls (page 71)
- Transfer a call (page 71)
- Record a call (page 72)
- Making a conference call (page 73)
- Transfer a call to Voice Mail (page 71)
- Access special features (page 88)

Note

- For information about establishing a conference call, see "Conference Call (Multiple Party Conversation) (Page 73)".

Holding a Call

You can put a call on hold by either holding the call at your extension (Call Hold) or holding the call in a parking zone of the PBX (Call Park).



Holding a call at your extension (Call Hold)

Operation in Line Buttons mode

To hold the current call

1. Press  (HOLD).

To retrieve a call on hold at your extension

1. On the **Calls** screen, do one of the following:
 - To retrieve an external call, press  (flashing CO button).
 - To retrieve an internal call, press .

Operation in Call List mode

To hold the current call

1. On the **Calls** screen, select the current call.
2. Press **Put the call on hold**.



To retrieve a call on hold at your extension

1. On the **Calls** screen, select the held call that you want to retrieve.
2. Press **Retrieve the Call**, and go off-hook.



Note

- If a call is not retrieved within a specified time, you will hear alarm as a reminder (Hold Recall). If an outside call is not retrieved within a specified time, it is automatically disconnected.
- Depending on the PBX's settings, you can retrieve a call held at another extension by entering a feature number. You can also retrieve another extension's held call by programming that extension as a flexible button.

For details about feature numbers for holding and retrieving calls, see "Call Hold (Page 92)".

For details about programming flexible buttons, see "Customizing the Flexible Buttons (Page 133)".





Holding a Call in a System Parking Zone (Call Park)

You can hold a call in a common parking zone. Calls held in a parking zone can be retrieved by any extension.





You can put a call in either an idle parking zone (automatic) or a specified parking zone (manual).

Operation in Line Buttons mode



To hold the current call in an idle parking zone

1. On the **Calls** screen, press  (**TRANSFER**).
 2. Press    .
- The display indicates the parking zone that the call was held in.
3. Go on-hook.

To hold a call in a specified parking zone

1. On the **Calls** screen, press  (**TRANSFER**).
2. Press   , and then enter the number of the parking zone to park the call in.
When you enter the parking zone number, use 2 digits (e.g., 04).
A window appears indicating the parking zone the call was held in.
3. On the window, press **OK**.
4. Go on-hook.

To retrieve a parked call

1. Press   , and then enter the number of the parking zone to retrieve the call from.
When you enter the parking zone number, use 2 digits (e.g., 04).
2. Go off-hook.

Operation in Call List mode

To hold a call in an idle parking zone

1. On the **Calls** screen, select the call you want to hold.
2. Press **Park the call (Automatic)**.



A window appears indicating the parking zone the call was held in.

3. On the window, press **OK**.

4. Go on-hook.

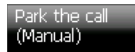

To hold a call in a specified parking zone

1. On the **Calls** screen, select the call you want to hold.
2. Press **Park the call (Manual)**.



3. In the **Park the call** window, use the dial keys to enter the number of the parking zone you want to hold the call in.

–or–

Press  and  to increase and decrease the parking zone number incrementally.

4. Press **OK**.
A window appears indicating the parking zone the call was held in.
5. On the window, press **OK**.
6. Go on-hook.

To retrieve a parked call

1. On the **Calls** screen, select the call you want to retrieve.
2. Press **Unpark the call**, and go off-hook.



!! Usage tips

- You can retrieve a call that was parked by another extension by using the procedure "To retrieve a parked call" in "Operation in Line Buttons mode (Page 70)".
- If a call is not retrieved within a specified time, you will hear an alarm as a reminder (Call Park Recall). If an outside call is not retrieved within a specified time, it is automatically disconnected.
- If you hear a reorder tone when retrieving a parked call, there is no held call. Confirm the stored parking zone number.
- After you park a call, you can perform other operations.

Receiving a Second Call (Answering Call Waiting)

During a conversation, if a second call arrives, the **Call Alert** window appears. You will also hear a call waiting tone.

1. On the **Call Alert** window, press **Answer**.
When you answer the second call, the current call will be put on hold.
2. To return to the original call, retrieve the held call.
See "Holding a Call (Page 69)".

Note

- To enable this feature, consult your administrator.



!! Usage tips

- Instead of answering the second call, you can redirect it. See "Redirecting Calls (Page 68)".

Talking to Two Parties Alternately (Call Splitting)

When you are talking to one party and have another party on hold, you can switch the call on hold and the current call.

Operation in Line Buttons mode

1. Press  (**TRANSFER**).
2. Call the second party.
3. Press  (**TRANSFER**).

Operation in Call List mode

1. On the **Calls** screen, select the call you want to put on hold.
2. Press **Transfer the Call**.



3. Call the second party.
4. Press **Split the Call**.

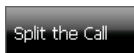

Transferring a Call (Call Transfer)

You can transfer a call to another destination (extension or outside party), or to your mailbox.

Operation in Line Buttons mode**To transfer a call**

1. Press  (**TRANSFER**).
2. Call the party you want to transfer the call to.
For details, see "Making Calls (Page 62)".
3. Wait until the other party answers to announce the transfer. (This step can be omitted.)
4. Go on-hook.

To transfer a call to an extension's mailbox

1. On the **Calls** screen, press the flexible button that is programmed as the Voice Mail Transfer button.
2. Enter the extension number of the mailbox to transfer the call to.
3. Go on-hook.

Note

- For details about creating a Voice Mail Transfer button, see "Customizing the Flexible Buttons (Page 133)".

Operation in Call List mode**To transfer a call using the touch screen**

1. On the **Calls** screen, select the call to transfer.
2. Press **Transfer the Call**.



The **Contacts** screen will appear.

3. Call the party you want to transfer the call to.
For details, see "Making a Call from the Contact List (Page 63)".
4. Wait until the other party answers to announce the transfer. (This step can be omitted.)
5. Go on-hook.

To transfer a call using the hard keys

1. On the **Calls** screen, select the call to transfer.
2. Press  (**TRANSFER**).
You will be switched to the **Contacts** screen, and the **Dial** window will appear.
3. Call the party you want to transfer the call to.
For details, see "Making Calls (Page 62)".
4. Wait until the other party answers to announce the transfer. (This step can be omitted.)
5. Go on-hook.

To transfer a call to an extension's mailbox

1. On the **Calls** screen, select the call to transfer.
2. Press **Transfer to VM**.



3. Enter the extension number of the mailbox you want to transfer the call to.
4. Press **OK**.
5. Go on-hook.

!! Usage tips

- When you are not at your desk or not in the office and receive a forwarded outside call, for example on your cellular phone, it is possible to transfer the call to an extension in the PBX by pressing # + desired extension number. For details, consult your administrator.

Note

- When you transfer a call to another extension, if the call is not answered within a specified time, the call may be transferred back to your extension.
If an outside call is transferred back to your extension and you do not answer within a specified time, the call will be disconnected.
- To transfer a call to a mailbox, you must program the voice mail extension number. For details, see "Dial Number Settings (Page 114)".

Mute

You can mute your voice during a conversation. While the mute is turned on, you will be able to hear the other party, but the other party will not be able to hear you. The built-in microphone, handset, and headset are all muted when the mute is turned on.

Operation in Line Buttons mode

To mute your voice

1. On the **Calls** screen, press .

To return to the conversation

1. On the **Calls** screen, press .

Operation in Call List mode

To mute your voice

1. On the **Calls** screen, press .

To return to the conversation

1. On the **Calls** screen, press .

!! Usage tips

- You can also mute your voice during a doorphone call. For details, see "Opening Doors (Page 82)".

Recording Calls (Two-way Recording)

You can record a conversation if a Panasonic Voice Processing System (VPS) (e.g., KX-TVA series) is connected. The call is recorded to your mailbox on the VPS.

Note

- To use this feature, you must program the voice mail extension number. For details, see "Dial Number Settings (Page 114)".

Operation in Line Buttons mode

To record a conversation

1. On the **Calls** screen, press the flexible button that you programmed as the Two-way Record button.

To stop recording

1. On the **Calls** screen, press the flexible button that you programmed as the Two-way Record button.

Note

- For details about creating a Two-way Record button, see "Customizing the Flexible Buttons (Page 133)".

Operation in Call List mode

To record a conversation

1. On the **Calls** screen, select the call you want to record.

2. Press **Record the call**.

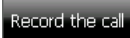

To stop recording

1. On the **Calls** screen, select the call you are recording.
2. Press **Stop Recording**.



!! Usage tips

- To listen to the recorded conversation, access your mailbox and follow the audio guidance. For details, see "Accessing Voice Mail (Page 77)".

Conference Call (Multiple Party Conversation)

During a conversation, you can add additional parties to your call and establish a conference call.

If you are added to a conference call, you cannot perform any of the conference operations explained in this section. In this case, you can leave the conference at any time by going on-hook.

Up to 8 parties (intercom and CO lines) can participate in a conference call.

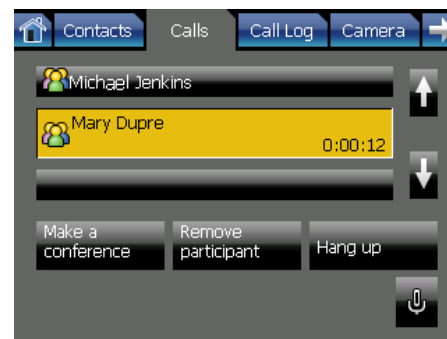

Calls screen during a conference call in Call List mode



Making a Conference Call

During a conversation, you can call another party and establish a conference call.

Operation in Line Buttons mode

1. Make a call to the first party you want to include in the conference.
For details, see "Making Calls (Page 62)".
2. Press  (**TRANSFER**), and then call the party you want to add to the conversation. For details, see "Making Calls (Page 62)".
3. After the called party answers, press  (**TRANSFER**) and then press .

Operation in Call List mode

1. Make a call to the first party you want to include in the conference.
For details, see "Making Calls (Page 62)".
2. On the **Calls** screen, press **Make a conference**.



The current call is put on hold, and the **Contacts** screen will appear.

3. Call the party you want to add to the conversation. For details, see "Making Calls (Page 62)".
4. After the called party answers, press **Make a conference** to begin the conference call.



!! Usage tips

- You can repeat this procedure to add additional parties to the conference. You can have a conference with a maximum of eight parties (comprising intercom or CO lines) simultaneously.
- During a three-party conversation, pressing  (**TRANSFER**) alternates between the other parties in the conversation.

Removing a Participant from the Conference

During a conference, you can remove other parties from the conference.

This feature is only available during a 3-party conference.

Operation in Line Buttons mode

1. Press  (**TRANSFER**) once or twice to establish a conversation with the party to be disconnected. The other party will be put on hold.
2. On the **Calls** screen, press **FLASH**.



This will disconnect the party.

3. Do one of the following:
 - Press the flashing green flexible button that corresponds to the original party.



- Press **INT'** if it is flashing.



Note

- The **FLASH** button must be set to Flash/Recall mode. For details, consult your administrator.

Operation in Call List mode

1. On the **Calls** screen, select the party you want to remove.
2. Press **Remove participant**.



The selected party is disconnected, and you can continue to speak with the remaining party or parties.

Leaving a Conference (Unattended Conference)

You can leave a conference call that you established and allow the other parties to continue the conversation. Both parties will hear an alarm tone before a specified timeout. You will also hear an alarm tone at your extension. The call is disconnected when the timer runs out unless you return to the conference.

Operation in Line Buttons mode

To leave a conference and be able to return

1. On the **Calls** screen, press the flexible button that you programmed as the conference button.
2. Go on-hook.
The other conference participants can continue talking.

To return to a conference

1. On the **Calls** screen, do one of the following:
 - Press the flashing green flexible button that corresponds to the call.



- Press **INT'** if it is flashing.



Note

- For details about creating a conference button, see "Customizing the Flexible Buttons (Page 133)".

Operation in Call List mode

To leave a conference and be able to return

1. On the **Calls** screen, select the call of one of the parties in the conference.

2. Press **Make a conference**.



3. Go on-hook.
The other conference participants can continue talking.

Note

- When you leave a conference, the status of the first conference participant changes to  (on hold). The statuses of the other parties do not change.

To return to a conference

1. On the **Calls** screen, select the call on hold.
2. Press **Retrieve the Call**.



–or–

Go off-hook.

!! Usage tips

- When a conference call includes more than 1 internal call, you can also return to the conference by simply going off-hook.

To leave a conference and not be able to return

1. Press  (**TRANSFER**).
2. Go on-hook.

Note

- To leave a conference call involving two outside parties and have the conversation continue, your extension must be enabled to transfer calls to CO lines through COS programming.

Locking Operations (Application Lock)

The Application Lock feature lets you restrict operation to only a few operation screens. When you set the Application Lock, you can still access some screens, such as the **HOME** and **Calls** screens.

If you try to access a screen that is locked, you will be prompted for a password to turn off Application Lock.

To use the Application Lock, you must enable the Application Lock feature. For details, see "Password Settings (Page 113)".

To set the Application Lock

1. On the **HOME** screen, press .

To cancel the Application Lock

1. On the **HOME** screen, press , or access a screen that is locked.
2. On the **Unlock Application** window, enter the Application Lock password.

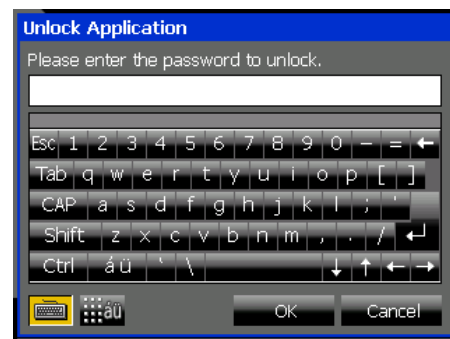

3. Press **OK**.

Note

- If you enter the wrong password a pre-programmed number of times, your extension will become locked. To unlock your extension, the PIN and PIN lock for your extension must be cleared. For details, consult your manager.

Checking Messages

When you receive a message waiting or a voice message, a button appears on the **HOME** screen and the Message/Ringer lamp lights red. You can check your new messages by pressing this button.

Checking New Messages

There are 3 types of messages you can receive at your extension:

- Message waiting.
- Messages on the PBX's built-in voice mail (Simplified Voice Message [SVM]).
- Messages on a Panasonic Voice Processing System (VPS) (e.g., KX-TVA series).

Note

- Depending on the network and PBX configurations, some message types might not be available. For details about which message types are available, consult your administrator.

Checking Message Waiting

Extension users can leave message waiting indications to indicate that they called and want you to return their call.

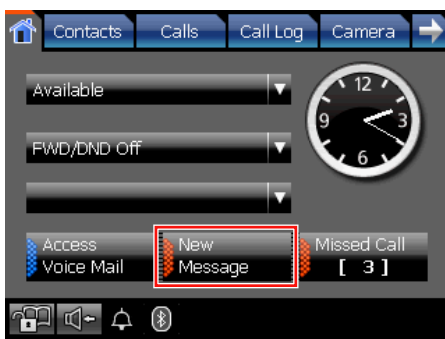

1. On the **HOME** screen, press **New Message**.



2. Press **Retrieve Message Waiting**.
3. Press the message you want to check.
4. Press **Call Back**.

!! Usage tips

- If you call back the party that left the message waiting and the party answers, the message will be removed from the message waiting list.

- If the **Calls** screen is set to Line Buttons mode, you can also check message waiting by pressing  on the **Calls** screen.
- You can delete the message waiting by pressing .

Checking Messages Stored on the Simplified Voice Message (SVM) System

If SVM is configured on the PBX, callers can leave short voice messages at your extension.

1. On the **HOME** screen, press **New Message**.

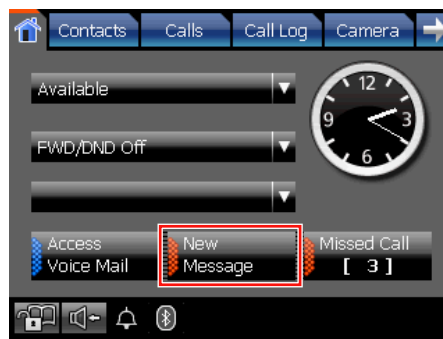

2. Press **Retrieve Message Waiting**.
3. Press the message from the SVM in the list.
4. Press **Call Back**.
You will be connected to the SVM. Follow the audio guidance.

!! Usage tips

- The message from the SVM is deleted automatically after checking all new messages on the SVM.
- You can also check messages on the SVM by accessing your voice mailbox using feature numbers. For details, see "Simplified Voice Message (SVM) (Page 104)".

Note

- Even if you have more than one new message on the SVM, only one message from the SVM is displayed.
- Checking messages on the SVM is not recorded in the outgoing call log.

Checking Messages Stored on a Panasonic Voice Processing System (VPS)

If a Panasonic VPS (e.g., KX-TVA series) is configured on your network, callers can leave voice messages in your mailbox.

1. On the **HOME** screen, press **New Message**.

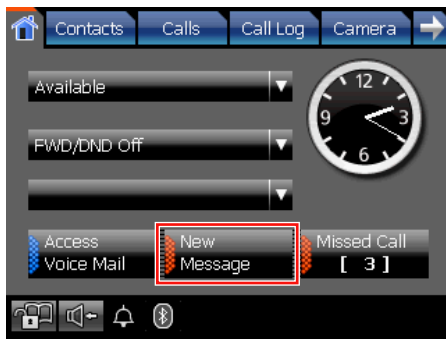

2. Press **Retrieve Voice Message**.
You will be connected to the voice mail system.
Follow the audio guidance.

Note

- The **Retrieve Voice Message** button is only displayed if you have set the voice mail system's extension number. For details, see "Dial Number Settings (Page 114)".

Accessing Voice Mail

You can access your voice mailbox from the **HOME** screen.

1. On the **HOME** screen, press **Access Voice Mail**.



You will be connected to the voice mail system.
Follow the audio guidance.

Note

- The **Access Voice Mail** button is displayed if you have set the voice mail system's extension number. For details, see "Dial Number Settings (Page 114)".

Checking Missed Calls

When there are new missed calls, the **Missed Call** button appears on the **HOME** screen and displays the number of missed calls that you have. The KX-NT400 can store the information for up to 100 missed calls.

1. Press **Missed Call** to display the **Missed** call log.

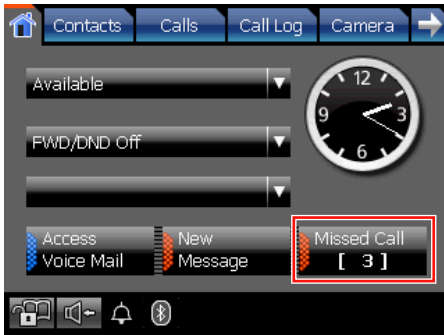

!! Usage tips

- If the **Calls** screen is set to Line Buttons mode, an orange line appears above the **HOME** tab when there are new missed calls.
- For details about making calls from a call log, see "Dialing by Using Call Logs (Page 65)".

Note

- Displaying the **Missed** call log clears the **Missed Call** button from the **HOME** screen. If the **Calls** screen is set to Line Buttons mode, the **HOME** tab also returns to its original appearance.

Presence Status Setting

Your presence status is displayed to other parties, letting them know whether you are available, in a meeting, away from your desk, etc.

The KX-NT400 has several preset presence statuses that you can select. You can also create custom presence statuses.

1. On the **HOME** screen, press the first drop-down list.

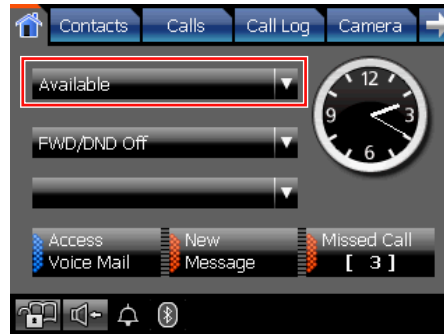

2. On the **Presence Select** window, select the desired presence status.
 - If you have created additional presence statuses, press **Custom** to display them.
 - Press **Options** to enter a custom presence status. For details, see "Setting a custom presence message".
 - Press **Close** to close the window without applying a presence status.

Setting a custom presence message

Pressing **Options** on the **Presence Select** window allows you to enter a temporary presence message.

1. On the **Presence Select** window, press **Options**.
2. Enter the desired presence message.
3. Press **OK**.
The message you set will be displayed to other parties.

Note

- Temporary presence messages are not saved. If you change your presence status, your custom message will be lost.

!! Usage tips

- You can customize the existing presence statuses, and add up to 8 new presence statuses. On the **Presence Select** window, use the Navigator key to select a presence status, and then press . You

can also change the presence settings via the **Options** screen.

For details, see "Presence Settings (Page 118)".

- You can assign Call Forwarding/Do Not Disturb settings to a presence status.
For details, see "Presence Setting Example 1 (Page 119)".
- You can assign a feature number to be executed when you select a presence status.
For details, see "Presence Setting Example 2 (Page 119)".
- Your presence status is stored on the PBX as an absent message.

Note

- Depending on the regional setting (suffix code) of the connected PBX, if you set the language to Russian or Ukrainian, your presence status might appear garbled.

Call Forwarding/Do Not Disturb

You can have incoming calls automatically forwarded to another destination. You can also have incoming calls rejected (Do Not Disturb).

Simple Call Forwarding Settings

You can set one forwarding destination for external and internal calls.

1. On the **HOME** screen, press the second drop-down list.



If call forwarding or Do Not Disturb is already set, the **Advanced** window appears. See "Advanced Call Forwarding/Do Not Disturb Settings (Page 80)".

2. On the **FWD/DND Settings** window, select one of the text fields.
3. Enter a forwarding destination.
4. Select the radio button of the destination you want to forward calls to.
5. Press **OK**.

!! Usage tips

- On the **FWD/DND Settings** window, the numbers you set for **Phone 1** and **Phone 2** are saved. These settings will be available the next time you set a forwarding destination.
Other is used for a temporary forwarding destination. Every time you set a forwarding destination, **Other** will be blank.
- You can set your cellular phone as the forward destination.

Advanced Call Forwarding/Do Not Disturb Settings

You can set different forwarding destinations as well as Do Not Disturb for external and internal calls separately.

1. On the **HOME** screen, press the second drop-down list.



If call forwarding or Do Not Disturb is already set, the **Advanced** window appears. Proceed to step 3.

2. On the **FWD/DND Settings** window, press **Advanced**.

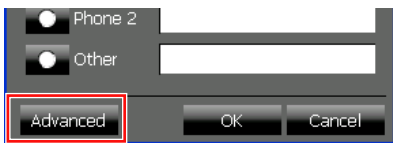

3. Set the forwarding settings for external and internal calls:
 - **Always (All)**: Forward all calls.
 - **Busy**: Only forward calls when you are busy (i.e., on a call).
 - **No answer**: Only forward calls when you do not answer the phone after a set amount of time.^{*1}
 - **Busy/No answer**: Forward calls when you are busy or do not answer after a set amount of time.^{*1}
 - **Do not disturb**: Reject incoming calls.

If you want to apply the same settings to both types of calls, select the **For both external calls and internal calls** check box.

4. Enter a forwarding destination for external and internal calls. See "Entering Text (Page 60)".
5. Press **OK**.

!! Usage tips

- On the **Advanced** window, you can press **Standard** to display the simple call forwarding settings.

^{*1} The no answer time can be set using a feature number. For details about entering feature numbers, see "Call Forwarding (FWD) (Page 91)".

Advanced Feature Operation

Network Camera

You can view the video feeds from up to 20 registered Panasonic Network Cameras (e.g., KX-HCM/BB-HCM/BL-C series). For details about registering cameras, see "IP Camera Settings (Page 116)".

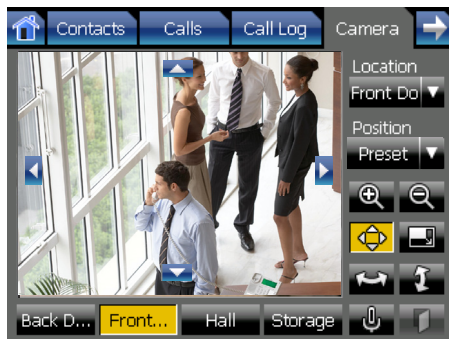

For details about the buttons and icons on the **Camera** screen, see "Camera Screen (Page 49)".

Network Camera Features

Camera Control

- You can control the selected camera, such as by zooming in and out, tilting and panning.
- You can view and control a camera while on a call.

Doorphone/Contact Integration

- If a camera is connected to a doorphone or registered to a contact in the contact list, the feed from that camera is automatically displayed when you receive a call from or make a call to that doorphone or contact.
- You can open the door connected to a doorphone from the **Camera** screen.

For details about registering cameras with contacts, see "Contact List (Page 108)".

Note

- Depending on the camera model, some operations might not be available.
- Some operations might not function due to security reasons, etc. For details, consult your administrator.
- If a camera feed does not display, see "Troubleshooting (Page 183)" for assistance.

Selecting Cameras to View

You can use the **Location** list or quick-access buttons to select the camera you want to view.

- Location** list: A list of all cameras that you have registered.
 - Quick-access buttons: 4 buttons to which you can assign frequently accessed cameras.
- Press the **Location** drop-down list, and then select the camera you want to view.



—or—

On the bottom of the screen, select the quick-access button of the camera you want to view.





You can assign which cameras are accessed with these buttons. For details, see "IP Camera Settings (Page 116)".

Note

- When on a call with a destination that has a registered camera, the location "Incoming" (for incoming calls) or "Outgoing" (for outgoing calls) is added to the **Location** drop-down list for the duration of the call.

Zooming In and Out

Use the following buttons to zoom in and out of the image:

-  : Zoom in
-  : Zoom out

Adjusting the Angle of the Camera

You can manually change the viewing angle of the camera, or select from positions programmed in the camera.

Changing the center point

1. Touch the video display area to center the camera at that point.

Panning and tilting the camera manually



1. Press  to enable the panning and tilting controls. Four arrows will appear along the edges of the video display.
2. Press the arrows to pan and tilt the camera.



Performing a pan/tilt scan

A pan/tilt scan is when the camera pans (horizontal) or tilts (vertical) as far as possible in one direction, and then pans/tilts as far as possible in the other direction. Finally, the camera returns to its original position.

Use the following buttons to perform a pan/tilt scan:

- : Perform a pan scan
- : Perform a tilt scan

Selecting a programmed position

1. Press the **Position** drop-down list, and then select the position you want to view.

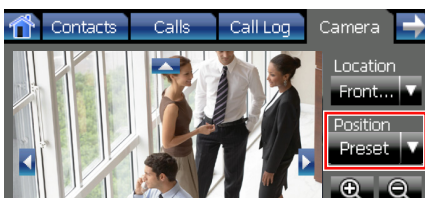

Note

- Positions are programmed via the camera's settings, and cannot be programmed from the KX-NT400.
- If a position name contains non-ASCII characters, the position name will appear garbled.
- The text "Preset" is always displayed in the **Position** drop-down list, even after you select a programmed position.

Opening Doors

If you are on a call with a doorphone and are viewing the feed from a camera integrated with the doorphone, you can open the door from the KX-NT400.



1. On the **Camera** screen, press .

!! Usage tips

- Press  to mute your voice during a doorphone call. For details about muting, see "Mute (Page 72)".

Full-Screen Mode

You can expand the video area to fill the entire screen.

1. On the **Camera** screen, press . In full-screen mode, you can do the following:
 - Press  (**ENTER**) on the Navigator key to move the camera to its home position.
 - Touch the screen or press  (**CANCEL**) to return to the **Camera** screen.

Chat

You can start a text chat with other KX-NT400 users, and users of programs such as Communication Assistant.

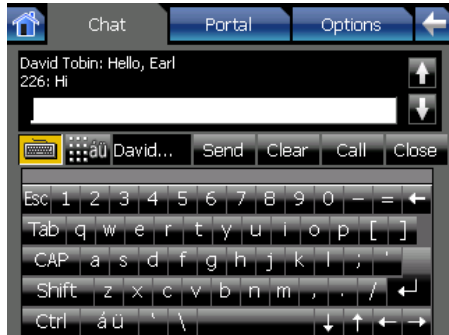

Note

- You cannot chat with CA users connected through CA Server. For details, consult your administrator.

For details about the buttons and icons on the **Chat** screen, see "Chat Screen (Page 52)".

To start a chat

- On the **Contacts** screen, select the contact with whom you want to chat. Detailed information for the selected contact will appear.
- Press **Start Chat**.

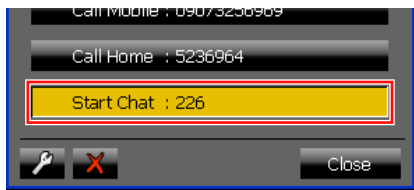

The **Chat** screen will appear.

- Enter a message using the soft keyboard or a connected USB keyboard.
- Press **Send**.

Receiving a chat request

When you receive a chat request, the **Chat Alert** window appears.

- Press **Answer** to accept the request. Press **Close** to reject the request.

!! Usage tips

- Use the following buttons to perform the chat operations:
 - Send**: Send the message you entered to the other chat participant.
 - Clear**: Erase the text in the input box.
 - Call**: Call the other chat participant.
 - Close**: End the current chat.
- During a chat, you can use all of the KX-NT400's features. To return to the **Chat** screen, press the **Chat** tab.
- Use **↑** and **↓** or **△ (UP)** and **▽ (DOWN)** on the Navigator key to scroll through the chat log.
- You can view up to 200 previous messages when scrolling through the chat log.
- You can back up the chat log to an SD memory card. For details, see "Data Maintenance (Page 166)".
- You can send the message by pressing the Enter key on the keyboard instead of pressing **Send**.

Note

- You can chat with only 1 person at a time.
- You can send up to 255 characters in a message.

Making a Call to a Chat Participant

After you start a text chat, you can call the other participant from the **Chat** screen.

- Start a text chat. See "Chat (Page 83)".
- Press **Call**.

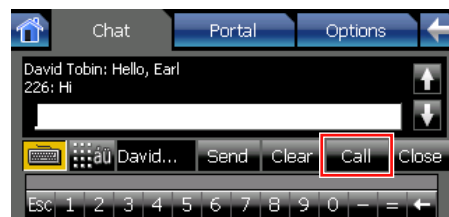

The call to the other chat participant will start, and the screen will change to the **Calls** screen.

Portal (Web Browser)

The KX-NT400 has a feature for browsing intranet Web pages, called the portal.

Note

- The portal is designed only for viewing intranet content.

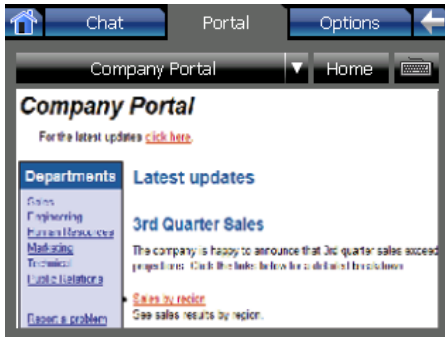

For details about the buttons and icons on the **Portal** screen, see "Portal Screen (Page 54)".

Portal Features

- Navigate intranet Web pages as you would with a browser on a computer or mobile phone.
- Use the soft keyboard or a connected USB keyboard to enter text, fill out forms, etc.
- Call phone numbers embedded in Web pages. For details, see "Making Calls from the Portal (Page 84)".
- Scroll the page vertically and horizontally by using the Navigator key.

Note

- Before you can view Web pages, you must program a list of pages that you can access from the portal.
- Certain pages might not display correctly in the portal.
- If pages do not display, see "Troubleshooting (Page 183)" for assistance.

Selecting a URL to Access

On the **Portal** screen, you can select a Web page to view. You can program a list of Web pages via the portal settings.

1. On the **Portal** screen, press the drop-down list.

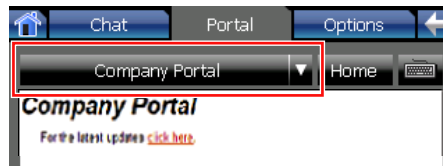

2. Select the Web page you want to view.

!! Usage tips

- For details about adding Web pages to the list, see "Portal Settings (Page 117)".

Going Back to Your Homepage

You can designate a Web page as your homepage, and you can easily display this page at any time.

1. On the **Portal** screen, press **Home**.

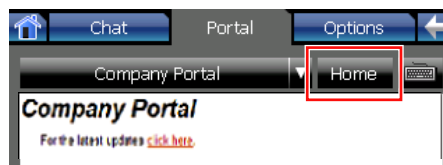

!! Usage tips

- For details about programming your homepage, see "Portal Settings (Page 117)".

Making Calls from the Portal

You can make phone calls directly from a Web page if the page has links that contain the "callto" command.

When you press a link that points to a phone number, the **Dial** window appears containing the phone number of the link:

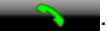

To call the phone number**1.** Do one of the following:

- Go off-hook.
- Press .

Note

- If you are off-hook when you press a link that points to a phone number, the number will be dialed immediately.
- You cannot use the dial keys to edit the number displayed in the **Dial** window when you are making a call from a Web page.

Other Feature Operations

When the Dialed Line is Busy or There is No Answer

When the party that you dialed is busy or does not answer, there are several ways to let the other party know that you called.

This section explains how to perform the following operations:

- Send a call waiting notification (page 86)
- Leave a message waiting indication (page 86)
- Leave a voice message (page 86)
- Reserve a busy line (page 87)
- Join the call (page 87)
- Overriding Do Not Disturb (DND Override) (Page 87)

Sending a Call Waiting Notification (Call Waiting)

When the dialed party is busy, you can send a call waiting notification to let the other party know you are calling. The called party will hear a call waiting tone at their extension.

Operation in Line Buttons mode

1. Press .

Operation in Call List mode

1. On the **Calls** screen, press **Wait and send call waiting**.

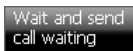

The dialed extension's status will change to "Ringing".

Note

- This feature is available only for internal calls.

Leaving a Message Waiting Indication

When the called party is busy or does not answer your call, you can leave a notification so that the called party can call you back.

Operation in Line Buttons mode

1. On the **Calls** screen, press **MSG**.



Operation in Call List mode

1. On the **Calls** screen, press **Leave message waiting**.

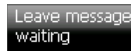

Note

- This feature is available only for internal calls.

Leaving a Voice Message

If the called party does not answer, you can leave a voice message.

To use this feature you must have a Panasonic Voice Processing System (VPS). You must also set the VPS's extension number. For details, see "Dial Number Settings (Page 114)".

This function is only available if the **Calls** screen is set to Call List mode.

1. On the **Calls** screen, press **Leave voice message**.

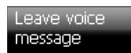

2. Follow the audio guidance to leave a message.

Note

- When you have an incoming call, the **Leave voice message** button is unavailable.
- This feature is available only for internal calls.
- If the **Calls** screen is set to Line Buttons mode, you must either wait to be redirected to the VPS or dial the VPS directly.

Reserving a Busy Line (Automatic Callback Busy)

If the called party is busy, you can receive a callback ringing from the extension when it becomes available.

Set your telephone to receive call-back ringing:

- When a dialed extension becomes idle.
- When the desired CO line that is in use by another extension becomes idle.

When you answer the call back ringing:

- For an intercom call:
The called extension starts ringing automatically.
- For an outside call:
The line is seized.

Operation in Line Buttons mode

1. Press **6**.

When the extension becomes idle, your KX-NT400 will ring. When you go off-hook, a call will be made to the called extension.

Operation in Call List mode

1. On the **Calls** screen, press **Set call back**.



When the extension becomes idle, your KX-NT400 will ring. When you go off-hook, a call will be made to the called extension.

Note

- If you do not answer the callback ringing within 10 seconds, this feature will be canceled.
- This feature is available only for internal calls.

Joining an Existing Conversation (Executive Busy Override)

If your extension has sufficient privileges, you can call a busy party and establish a 3-party conference.

Operation in Line Buttons mode

1. Press **3**.

You will join the called party's conversation and establish a 3-party conference.

Operation in Call List mode

1. On the **Calls** screen, press **Override (Conference)**.



You will join the called party's conversation and establish a 3-party conference.

!! Usage tips

- You can also deny others the possibility of joining your conversation (Default: **Allow**). For details, see "Executive Busy Override Deny (Page 97)".

Note

- To join another conversation, you must have Executive Busy Override enabled at your extension through COS programming.
- If Executive busy Override Deny has been set for the called party, this operation is unavailable. For details, consult your administrator.
- This feature is available only for internal calls.

Overriding Do Not Disturb (DND Override)

If your extension has sufficient privileges, you can call someone even if they have set DND.

Operation in Line Buttons mode

1. Press **1**.

Operation in Call List mode

1. On the **Calls** screen, press **Override the Call**.



Note

- To perform this operation, you must have DND Override enabled at your extension through COS programming.

If a Host PBX is Connected

Accessing External Services (External Feature Access [EFA])

You can access special features (e.g., Call Waiting) offered by a host PBX or telephone company. This feature is only effective for an outside call.

Operation in Line Buttons mode

1. During an outside conversation, on the **Calls** screen, press **FLASH**.

A rectangular button with the word "FLASH" in white capital letters on a dark background.

2. If required, enter the service code for the feature you want to access.

Operation in Call List mode

1. During an outside conversation, on the **Calls** screen, press **Send Flash**.

A rectangular button with the text "Send Flash" in white on a dark background.

2. If required, enter the service code for the feature you want to access.

Note























- For operation in Line Buttons mode, the **FLASH** button must be set to External Feature Access (EFA) mode. For details, consult your administrator.
- Available service codes differ depending on your telephone system and services offered by your telephone company.

PBX Feature List

You can use the following PBX features. For details, refer to the corresponding sections in this guide or to the Operating Manual for the connected PBX.



Note



- The PBX features marked with a ★ icon are only available for the manager extension.
- The buttons with [] do not exist by default. To create the buttons, see "Customizing the Flexible Buttons (Page 133)".







































Feature	Operation
<p>Absent Message</p> <p>You can show the reason you do not answer, if the caller uses a Panasonic display proprietary telephone.</p> <p>There are eight preprogrammed messages and one for your personal message (16 characters).</p> <p></p> <ul style="list-style-type: none"> • Presence Status Setting (Page 78) 	<p>To set</p> <p>    +  -  (parameter) + </p> <p>To cancel</p> <p>    </p>
<p>Account Code Entry</p> <p>You may give a specified account code to extension users and check their telephone usage. You can specify an account code for each client and check the call duration.</p>	<p>   + account code +  + outside phone no.</p>
<p>Alternate Calling—Ring/Voice</p> <p>The caller can alternate the alerting method, either ring or voice, when making an intercom call. On the other hand, any extension can set the alerting method, either ring or voice, when receiving an intercom call.</p>	<p></p>
<p>Automatic Callback Busy</p> <p>You can set the telephone to receive callback ringing:</p> <ul style="list-style-type: none"> • when a dialed extension becomes idle. (After you answer the callback ringing, the previously dialed extension number is automatically redialed.) • when your desired CO line that is in use by another extension becomes idle. (After you answer the callback ringing, you can make a call using the seized CO line.) <p></p> <ul style="list-style-type: none"> • Reserving a Busy Line (Automatic Callback Busy) (Page 87) 	<p>To set</p> <p></p> <p>To cancel</p> <p>  </p>



























Feature	Operation
<p>Automatic Line Access You can select an idle CO line automatically.</p>	<p>9 + outside phone no.</p>
<p>Background Music (BGM) You can listen to the background music through your telephone speaker while on-hook. An external music source, such as a radio, must be connected. If your extension becomes busy (off-hook, making or receiving a call etc.), the music stops temporarily. When you go back on-hook, the music starts again.</p>	<p>To set * 7 5 1 + BGM no. (1 digit)</p> <p>To cancel * 7 5 1 0</p>



Feature	Operation
<p>Call Forwarding (FWD) You can have your incoming calls forwarded to a specified destination.</p>  <ul style="list-style-type: none"> • Call Forwarding/Do Not Disturb (Page 79) 	<p>To set * 7 1 + 0 (Both Calls)/ 1 (Outside Calls)/ 2 (Intercom Calls) + 2 (All Calls) + phone no. + # / 3 (Busy) + phone no. + # / 4 (No answer) + phone no. + # / 5 (Busy/No answer) + phone no. + #</p> <p>To cancel * 7 1 + 0 (Both Calls)/ 1 (Outside Calls)/ 2 (Intercom Calls) + 0</p> <p>To set Follow Me from another extension * 7 1 + 0 (Both Calls)/ 1 (Outside Calls)/ 2 (Intercom Calls) + 7 + your extension no.</p> <p>To cancel Follow Me from another extension * 7 1 + 0 (Both Calls)/ 1 (Outside Calls)/ 2 (Intercom Calls) + 8 + your extension no.</p> <p>To set the timer for "No answer" and "Busy/No answer" * 7 1 3 + 0 0 - 9 9 (second)</p> <p>To set Call Forwarding for your Incoming Call Distribution (ICD) Group * 7 1 + 4 (Both Calls)/ 5 (Outside Calls)/ 6 (Intercom Calls) + 1 + ICD group extension no. + phone no. + #</p> <p>To cancel Call Forwarding for your ICD Group * 7 1 + 4 (Both Calls)/ 5 (Outside Calls)/ 6 (Intercom Calls) + 0 + ICD group extension no.</p>

Feature	Operation
<p>Call Forwarding to Voice Mail (Voice Mail Integration)</p> <p>If a Voice Processing System is connected, you can forward them to your mailbox when you cannot answer calls.</p>  <ul style="list-style-type: none"> • Call Forwarding/Do Not Disturb (Page 79) 	<p>To set</p> <p>* 7 1 + 0 (Both Calls)/ 1 (Outside Calls)/ 2 (Intercom Calls) + 2 (All Calls) + voice mail extension no. + # / 3 (Busy) + voice mail extension no. + # / 4 (No answer) + voice mail extension no. + # / 5 (Busy/No answer) + voice mail extension no. + #</p> <p>To cancel</p> <p>* 7 1 + 0 (Both Calls)/ 1 (Outside Calls)/ 2 (Intercom Calls) + 0</p> <p>To transfer a call to a mailbox Feature key screen* + [Voice Mail Transfer] + [DSS]</p> <p>To listen to message voice mail extension no.</p> <p>Note The default voice mail extension number is 500.</p>
<p>Call Hold</p> <p>You can put a call on hold.</p>  <ul style="list-style-type: none"> • Holding a call at your extension (Call Hold) (Page 69) 	<p>To hold a call</p> <p> (TRANSFER) + * 5 0</p> <p>To retrieve a call</p> <p>* 5 0</p> <p>To retrieve a call by specifying a held line number</p> <p>* 5 3 + CO line no. which is held (3 digits)</p> <p>To retrieve a call by specifying a holding extension number</p> <p>* 5 1 + extension no. which has a held call</p>
<p>Calling Line Identification Restriction (CLIR)</p> <p>When making an outside call, you can select whether the called party can see your telephone number or not.</p>	<p>To show</p> <p>* 7 * 1 0</p> <p>To prevent</p> <p>* 7 * 1 1</p>

Feature	Operation
<p>Calling/Connected Line Identification Presentation (CLIP/COLP)</p> <p>You can select the telephone number sent, either the number of the line used or the number assigned to your extension.</p> <p>CLIP: When making an outside call, you can present your preprogrammed telephone number to the called party.</p> <p>COLP: When receiving an outside call, you can present your preprogrammed telephone number to the calling party.</p>	<p>To show the CO line number * 7 * 2 1</p> <p>To show your extension number * 7 * 2 2</p>
<p>Call Monitor</p> <p>The preprogrammed extension can monitor another extension.</p>	<p>extension no. + 5</p>
<p>Call Park</p> <p>You can put a call on hold in a common parking zone of the PBX so that any extension can retrieve the parked call. You can use this feature as a transferring feature.</p> <p></p> <ul style="list-style-type: none"> Holding a Call in a System Parking Zone (Call Park) (Page 70) 	<p>To set (specified)  (TRANSFER) + * 5 2 + parking zone no. (2 digits)</p> <p>To set (automatically)  (TRANSFER) + * 5 2 *</p> <p>To retrieve * 5 2 + stored parking zone no. (2 digits)</p>
<p>Call Pickup</p> <p>You can answer an incoming call that is ringing at another extension or group from your phone without leaving your desk.</p> <p>The following types of pickup are available:</p> <p>Group Call Pickup: Picks up a call within your group.</p> <p>Directed Call Pickup: Picks up a specified extension's call.</p>	<p>Group Call Pickup * 4 0 + group no. (2 digits)</p> <p>Directed Call Pickup * 4 1 + extension no.</p>
<p>Call Pickup Deny</p> <p>You can deny or allow other people to pick up your calls.</p>	<p>To deny * 7 2 0 1</p> <p>To allow * 7 2 0 0</p>



























Feature	Operation
<p>Call Splitting</p> <p>When talking to one party while the other party is on hold, you can swap the calls back and forth (alternately).</p>  <ul style="list-style-type: none"> Talking to Two Parties Alternately (Call Splitting) (Page 71) 	<p>To alternate between the parties leaving one party on hold temporarily</p> <p> (TRANSFER) + extension no. + Talk +  (TRANSFER) + Talk</p> <p>To leave the conversation and then let the two parties talk</p> <p> (TRANSFER) + extension no. + Talk +  (TRANSFER) + go on-hook</p>
<p>Call Transfer</p> <p>You can transfer a held call without talking, and go on-hook even if the transferred party does not answer the call.</p>  <ul style="list-style-type: none"> Transferring a Call (Call Transfer) (Page 71) 	<p>Call Transfer</p> <p> (TRANSFER) + phone no.</p>
<p>Call Waiting</p> <p>Sending a Call Waiting:</p> <p>You can inform the called party that your call is waiting.</p> <p>Answering Call Waiting in the PBX:</p> <p>During a conversation, a call waiting tone or voice announcement through the speaker or the handset occurs when an outside call has been received or another extension is letting you know a call is waiting.</p> <p>Answering Call Waiting from the Telephone Company:</p> <p>This is an optional telephone company service. You can receive a call waiting tone and the caller's information. For details, consult your telephone company.</p> <p>Receiving Call Waiting:</p> <p>During a conversation, you can be informed of a call waiting with a tone or voice announcement through your built-in speaker or handset.</p>  <ul style="list-style-type: none"> When the Dialed Line is Busy or There is No Answer (Page 86) 	<p>To send a Call Waiting Notification</p> <p></p> <p>To disconnect the second call and then talk to the original party</p> <p>go on-hook + go off-hook +   </p> <p>To answer a Call Waiting from the Telephone Company</p> <p> (TRANSFER) +   </p> <p>To set for intercom calls</p> <p>    +  (Tone)/  (Whisper OHCA)</p> <p>To cancel for intercom calls (Manual Call Waiting)</p> <p>     (No call)</p> <p>To set for outside calls (Automatic Call Waiting)</p> <p>     (Tone)</p> <p>To cancel for outside calls</p> <p>     (No tone)</p>
<p>CO Line Group Access</p> <p>You can select an idle CO line in the specified CO line group automatically.</p>	<p> + CO line group no. (2 digits) + outside phone no.</p>















































Feature	Operation
<p>Conference You can add one or more parties to your conversation.</p> <p> <ul style="list-style-type: none"> Conference Call (Multiple Party Conversation) (Page 73) </p>	<p>To establish a conference  (TRANSFER) + phone no. + Talk +  (TRANSFER) + </p> <p>To disconnect one party in Line Buttons mode (3-party conference only)  (TRANSFER) once or twice to establish a conference with the party to be disconnected + FLASH + flexible button/INT' (corresponding to original party)</p>
<p>Conference, Unattended The person who originated a conference can leave the conference, and allow the other parties to continue the conversation.</p>	<p>To leave a conference (3- to 7-party conference) Feature key screen¹ + [Conference] + go on-hook</p> <p>To return while others are talking Feature key screen¹ + flexible button/INT' (corresponding to original party)</p>
<p>Connected Line Identification Restriction (COLR) When receiving an outside call, you can select whether the caller can see your telephone number or not.</p>	<p>To show     </p> <p>To prevent     </p>
<p>Data Line Security You can protect the line against audible notification tones, such as a call waiting tone during a conversation. Set this feature if your extension has a data communication device, such as a PC or fax machine connected to ensure secure data transmission.</p>	<p>To set     </p> <p>To cancel     </p>
<p> Dial Tone Transfer The manager extension can change the restriction level, permitting an extension to make a call.</p>	<p>Feature key screen¹ + [Toll Restriction]</p>



Feature	Operation
<p>Direct Inward System Access (DISA)</p> <p>When outside callers access extensions in the PBX, a prerecorded message greets the caller and gives information about how to access an extension. You do not need the operator's assistance.</p> <p>You may be able to access system features or call an outside party with your password depending on the security mode.</p> <p>CAUTION</p> <p>There is a risk that fraudulent telephone calls will be made using the Outside-to-Outside Call feature of DISA.</p> <p>The cost of such calls will be billed to the owner/renter of the PBX.</p> <p>To protect the PBX from this kind of fraudulent use, we strongly recommend:</p> <ol style="list-style-type: none"> Enabling DISA security (CO line Security or All Security). Keeping your passwords (verification code PIN/extension PIN) secret. Selecting complex, random PINs that cannot be easily guessed. Changing PINs regularly. 	<p>To call an extension (In No Security Mode/CO line Security Mode) DISA phone no. + extension no.</p> <p>To call an extension (In All Security Mode only) DISA phone no. + * 4 7 + your extension no./ (* + verification code) + extension PIN/verification code PIN + extension no.</p> <p>To call an outside party (In No Security Mode) DISA phone no. + outside phone no.</p> <p>To call an outside party (In CO line Security Mode/All Security Mode) DISA phone no. + * 4 7 + your extension no./ (* + verification code) + extension PIN/verification code PIN + outside phone no.</p> <p>To retry * + phone no.</p>
<p>DND Override</p> <p>The preprogrammed extension can call someone who has set the DND feature.</p>	<p>extension no. + 1</p>
<p>Do Not Disturb (DND)</p> <p>You can set this feature to prevent incoming calls from ringing at your extension. This can be useful, for example, when you are in a meeting or busy.</p> <p></p> <ul style="list-style-type: none"> Call Forwarding/Do Not Disturb (Page 79) 	<p>To set * 7 1 + 0 (Both Calls)/ 1 (Outside Calls)/ 2 (Intercom Calls) + 1</p> <p>To cancel * 7 1 + 0 (Both Calls)/ 1 (Outside Calls)/ 2 (Intercom Calls) + 0</p>
<p>Doorphone Call/Door Open</p> <p>You can talk to a person at the door through the doorphone. Also, you can open the door.</p> <p></p> <ul style="list-style-type: none"> Opening Doors (Page 82) 	<p>To call the doorphone * 3 1 + doorphone no. (2 digits)</p> <p>To open the door from a specified extension * 5 5 + doorphone no. (2 digits)</p> <p>To open the door from any extension while talking to the doorphone 5</p>

Feature	Operation
<p>Enhanced Walking Extension</p> <p>In addition to exchanging the settings between extensions (Walking Extension), you can change the status of your extension to "Service-in" or "Service-out" (Enhanced Walking Extension).</p> <p>Service-in: An extension is in use (normal status).</p> <p>Service-out: Extension Dial Lock and Do Not Disturb (DND) are activated on an extension, and the extension user cannot make unauthorized outside calls nor receive calls.</p> <p>Notice</p> <ul style="list-style-type: none"> After you have exchanged the settings between extensions, the KX-NT400 must be restarted for the change to take effect. See "Manual Restarting (System Reset) (Page 168)". 	<p>To set an extension to Service-out status * 7 2 7 #</p> <p>To set an extension to Service-in status and have your own settings available * 7 2 7 * + your extension no. + extension PIN</p>
<p>Executive Busy Override</p> <p>The preprogrammed extension can call someone who is busy on the telephone and establish a three-party conversation.</p> <p></p> <ul style="list-style-type: none"> Joining an Existing Conversation (Executive Busy Override) (Page 87) 	<p>phone no. + 3</p>
<p>Executive Busy Override Deny</p> <p>You can prevent other people from joining your conversation.</p>	<p>To allow * 7 3 3 0</p> <p>To prevent * 7 3 3 1</p>
<p>Extension Dial Lock</p> <p>You can lock your extension so that other users cannot make unauthorized outside calls.</p>	<p>To lock * 7 7 1</p> <p>To unlock * 7 7 0 + extension PIN</p> <p>To make an outside call while your extension is locked * 4 7 + your extension no. + extension PIN + phone no.</p>

Feature	Operation
<p>Extension Feature Clear</p> <p>You can reset the settings of some features on your extension to the default settings with one operation.</p>	<p>✳ 7 9 0</p>
<p>Extension PIN (Personal Identification Number)</p> <p>You can assign a password to each extension. The following features require an extension PIN.</p> <ol style="list-style-type: none"> 1. Screening calls (Live Call Screening [LCS]) 2. Prohibiting other people from seeing your personal speed dialing directory, call log, SVM log, and from playing back the voice messages in your message box (Display Lock) 3. Using the same settings as your extension at other extensions (Walking Extension) 4. Remote Control Operation (Walking COS) 5. Extension Dial Lock Clear <p>CAUTION</p> <p>There is a risk that fraudulent telephone calls will be made if a third party discovers your password (extension PIN). The cost of such calls will be billed to the owner/renter of the PBX. To protect the PBX from this kind of fraudulent use, we strongly recommend:</p> <ol style="list-style-type: none"> a. Keeping your PIN secret. b. Selecting a complex, random PIN that cannot be easily guessed. c. Selecting complex, random PINs that cannot be easily guessed. d. Changing your PIN regularly. <ul style="list-style-type: none"> • Valid numbers for an extension PIN are "0" through "9". • If the wrong extension PIN is entered a preprogrammed number of times, the PIN is locked. • If you forget your extension PIN or your extension PIN is locked, your manager can clear the extension PIN and extension PIN lock. 	<p>To set</p> <p>✳ 7 9 9 1 + extension PIN + # + same extension PIN + #</p> <p>To cancel</p> <p>✳ 7 9 9 0 + stored extension PIN</p>
<p>★ External Background Music (BGM)</p> <p>The manager extension can broadcast background music in the office through external speakers.</p>	<p>To stop</p> <p>✳ 3 5 1 0</p> <p>To start</p> <p>✳ 3 5 1 1</p>

Feature	Operation
<p>External Feature Access (EFA)</p> <p>If a host PBX is connected, you can access special features (e.g., Call Waiting) offered by the host PBX or telephone company. This feature is only effective for an outside call.</p> <p></p> <ul style="list-style-type: none"> Accessing External Services (External Feature Access [EFA]) (Page 88) 	<p><Example> To hold the current call and then talk to the new party</p> <p> (TRANSFER) +    + service code</p>
<p>External Relay</p> <p>If an external relay is connected, preprogrammed extensions can switch on a relay (e.g., alarm) connected to the PBX.</p>	<p>   + relay no. (2 digits)</p>
<p>External Sensor</p> <p>If an external sensor is connected, preprogrammed extensions can receive an alert call from an external sensor (e.g., security alarm) connected to the PBX.</p>	<p>Off-hook</p>
<p> Group Paging</p> <p>You can make a voice announcement to proprietary telephones or external speakers or both in the preset group simultaneously.</p>	<p>To page</p> <p>   + paging group no. (2 digits)</p> <p>To answer</p> <p>  </p> <p>To deny (Paging Deny)</p> <p>    </p> <p>To allow</p> <p>    </p>
<p>Hands-free Answerback</p> <p>You can answer an incoming call without going off-hook as soon as the line is connected. When an intercom call arrives, you will hear the caller talking without the phone ringing. When an outside call arrives, you will hear the caller talking after a preprogrammed number of rings. Hands-free Answerback for outside calls requires system programming.</p> <p></p> <ul style="list-style-type: none"> Auto answer (Page 67) 	<p>Options tab + Administrator Options + Programming + AUTO ANS/MUTE</p>

Feature	Operation
<p>Headset Operation</p> <p>You can have a conversation using a headset. In this case, you must select "Headset on" in programming mode or set the Headset button on (red) in advance.</p>  <ul style="list-style-type: none"> Basic Operations (Page 58) 	<p>To talk using the headset  (SP-PHONE)</p> <p>To use the handset during a conversation using the headset Off-hook</p> <p>To talk in hands-free mode during a conversation using the headset Feature key screen¹ + [Headset]</p>
<p>Hospitality Features—Remote Wake-up Call</p> <p>The hotel operator can remotely set or cancel a Timed Reminder to a room extension. This allows guests to request wake-up calls without having to program the extension themselves. The hotel operator can also confirm the current Timed Reminder setting for a room extension.</p>	<p>To set      + extension no. + hour/minute +  (AM)/  (PM) +  (once)/  (daily) —or—      + extension no. + hour/minute +  (once)/  (daily)</p> <p>To cancel      + extension no.</p> <p>To confirm      + extension no.</p>
<p>Hot Line</p> <p>You can make an outside call simply by going off-hook if you have preprogrammed your phone.</p>	<p>To store       + phone no. + </p> <p>To set      </p> <p>To cancel     </p>
<p>Last Number Redial</p> <p>You can make a call to the outside party whom you last called.</p>	<p></p>
<p>Live Call Screening (LCS)</p> <p>While a caller is leaving a message in your mailbox, you can monitor the call without answering.</p>	<p>To set Live Call Screening Feature key screen¹ + [Live Call Screening] + extension PIN</p> <p>To cancel Live Call Screening Feature key screen¹ + [Live Call Screening]</p>



Feature	Operation
<p>Log-in/Log-out, Wrap-up</p> <p>You can control your status in an incoming call distribution group.</p> <p>When in the Log-out mode, incoming calls to the group will not ring at your extension. When you return, calls will again ring at your extension (Default: Log-in). Even if your extension is logged-in, you can have a specified time period (wrap-up time) when you will not receive calls after completing a previous call. This time can be used for you to write a report and so on. You can also manually select "Not Ready" mode to temporarily leave a distribution group.</p>	<p>To set Log-out</p> <p>* 7 3 6 0 + ICD group extension no. (Specified)/ * (All)</p> <p>To set Log-in</p> <p>* 7 3 6 1 + ICD group extension no. (Specified)/ * (All)</p> <p>To enter Ready mode</p> <p>* 7 3 5 0</p> <p>To enter Not Ready mode</p> <p>* 7 3 5 1</p> <p>To toggle Ready/Not Ready/Wrap-up mode</p> <p>Feature key screen¹ + [Wrap-up]</p>
<p>Manual Queue Redirection</p> <p>When your incoming call distribution group is busy and other outside calls arrive, the arriving calls are put in a waiting queue. Extensions can check the status of the queue with the Hurry-up button light, and forward the longest waiting call in the queue to a preset destination manually.</p>	<p>Feature key screen¹+ [Hurry-up]</p>
<p>Message Waiting (for a caller)</p> <p>When the called extension is busy or does not answer your call, you can leave a notification so that the called party may call you back.</p> <p></p> <ul style="list-style-type: none"> Leaving a Message Waiting Indication (Page 86) 	<p>To leave a message waiting indication</p> <p>4</p> <p>To leave a message waiting indication directly without calling</p> <p>* 7 0 1 + extension no.</p> <p>To cancel</p> <p>* 7 0 0 + extension no.</p>
<p>Message Waiting (for a called extension)</p> <p>As a message receiver, the Message/Ringer Lamp lets you know that a call has been received. If you receive notification, you can call the caller back by a simple operation.</p> <p></p> <ul style="list-style-type: none"> Checking New Messages (Page 76) 	<p>To call back</p> <p>* 7 0 2</p> <p>To clear message waiting indications</p> <p>* 7 0 0 + your extension no.</p>





Feature	Operation
<p>★ Network Direct Station Selection (NDSS) Monitor Release</p> <p>An NDSS button allows an extension user to monitor another extension connected to another PBX in a private network. When it becomes unnecessary to monitor an extension via NDSS, the manager can stop the PBX from monitoring it. Any NDSS buttons set to monitor that extension will also stop monitoring.</p>	<p> + another PBX extension no. + </p>
<p>Off-hook Monitor</p> <p>You can let other people in the room listen to the conversation through the speaker while continuing the conversation using the handset.</p>	<p> (SP-PHONE)</p>
<p>Operator Call</p> <p>You can call an extension or a group assigned as the operator.</p> <p></p> <ul style="list-style-type: none"> • Making a Call (Page 62) 	<p></p>
<p>Personal Speed Dialing</p> <p>You can store up to 100 numbers at your extension for your personal use.</p>	<p>To store a phone number</p> <p> + personal speed dialing no. (2 digits) + phone no. + </p> <p>To dial</p> <p> + personal speed dialing no. (2 digits)</p>
<p>Primary Directory Number (PDN)/ Secondary Directory Number (SDN) Extension</p> <p>Primary Directory Number (PDN) buttons and Secondary Directory Number (SDN) buttons are useful when extension users will handle calls for other extensions. For example, a secretary or multiple secretaries can handle calls and check the call status of a boss or multiple bosses.</p>	<p>SDN Direct Dial–Enhanced DSS Key Mode Feature key screen¹ + [SDN]</p> <p>SDN Direct Dial–Standard DSS Key Mode Feature key screen¹ + [SDN] + [SDN]</p> <p>Call Hold and Call Hold Retrieve Feature key screen¹ + [PDN]/[SDN]</p>
<p>Printing Message</p> <p>You can record a variety of information from your extension using up to 8 preprogrammed messages. Message information from all extensions is recorded with the PBX. For example, it is possible to use this feature as a time card by selecting preprogrammed "sign in" and "sign out" messages.</p>	<p> + message no. (+ parameter) + </p>

Feature	Operation
<p>★ Recording Out Going Message (OGM)</p> <p>The manager extension can record three kinds of greeting messages (OGM) as follows:</p> <ol style="list-style-type: none"> 1. DISA message Used to greet and guide callers so that they access an extension user group or outside party without operator assistance. 2. Incoming Call Distribution Group message Used to greet and guide callers to an incoming call distribution group. 3. Timed Reminder message Used for a wake-up call message when the extension answers the Timed Reminder. 	<p>To record Options tab + Administrator Options + Programming + * 3 6 1 + OGM floating extension no. + AUTO DIAL/STORE</p> <p>To play back * 3 6 2 + OGM floating extension no.</p> <p>To record from an external BGM (MOH) port Options tab + Administrator Options + Programming + * 3 6 3 1 + OGM floating extension no. + CONF + AUTO DIAL/STORE</p> <p>To clear the message * 3 6 0 + OGM floating extension no.</p> <p>Note The default of OGM floating extension numbers is 5xx (xx: two-digit number of message).</p>
<p>Remote COS Access</p> <p>You can use your calling privileges (Class of Service) at another extension. You may override restrictions which have been set. To use this feature, an original extension number and an extension PIN (Personal Identification Number) are required. You can make a call by entering a verification code and verification code PIN.</p>	<p>To call (Walking COS) * 4 7 + your extension no. + extension PIN + phone no.</p> <p>To call with a verification code (Verification Code Entry) * 4 7 * + verification code + verification code PIN + outside phone no.</p>
<p>★ Remote Extension Dial Lock</p> <p>The manager extension can lock other extensions.</p>	<p>To unlock * 7 8 2 + extension no.</p> <p>To lock * 7 8 3 + extension no.</p>
<p>Remote Setting</p> <p>You can set the following features on your telephone from another extension or through DISA.</p> <ul style="list-style-type: none"> • Call Forwarding (FWD)/Do Not Disturb (DND) • Changing the Log-in/Log-out Status of Extensions • Absent Message • Extension Dial Lock • Time Service—Changing the Time Mode (Day/Night/Lunch/Break) 	<p>From another extension * 4 7 + your extension no. + extension PIN + feature no.</p> <p>Through DISA DISA phone no. + * 4 7 + your extension no. + extension PIN + feature no.</p>

Feature	Operation
<p>Simplified Voice Message (SVM)</p> <p>Your PBX can provide you with answering machine service. Your extension is assigned a message box, into which callers can leave voice messages for you.</p> <p>After callers reach your message box, they will hear your personal greeting message. You can record two kinds of personal greetings: a normal greeting message and a greeting message for each time mode. You can also play back and clear your greeting messages and the voice messages left by callers.</p>	<p>To record a normal greeting message * 3 8 1</p> <p>To play back a normal greeting message * 3 8 2</p> <p>To clear a normal greeting message * 3 8 0</p> <p>To record a greeting message for each time mode * 3 8 8 + 0 (Day)/ 1 (Night)/ 2 (Lunch)/ 3 (Break) + 1</p> <p>To play back a greeting message for each time mode * 3 8 8 + 0 (Day)/ 1 (Night)/ 2 (Lunch)/ 3 (Break) + 2</p> <p>To clear a greeting message for each time mode * 3 8 8 + 0 (Day)/ 1 (Night)/ 2 (Lunch)/ 3 (Break) + 0</p>

Feature	Operation
	<p>To redirect your calls to your message box * 7 1 + 0 (Both Calls)/ 1 (Outside Calls)/ 2 (Intercom Calls) + 2 (All Calls) + floating extension no. for the SVM feature + # / 3 (Busy) + floating extension no. for the SVM feature + # / 4 (No answer) + floating extension no. for the SVM feature + # / 5 (Busy/No answer) + floating extension no. for the SVM feature + #</p> <p>Note The default floating extension number for the SVM feature is 591.</p> <p>To leave a voice message directly to another extension mailbox * 3 8 # 6 + extension no.</p> <p>To listen to voice message * 3 8 3 –or– * 7 0 2</p> <p>To listen to voice message by skipping to the desired message Press MESSAGE until desired SVM Log appears + go off-hook</p> <p>To clear the voice message that you are listening to 3 1</p>
<p>System Speed Dialing You can make calls using speed dialing numbers stored in the PBX.</p>	<p>* * + system speed dialing no. (3 digits)</p>
<p>TIE Line Access You can access extensions connected to other PBXs in a private network.</p>	<p>7 + private phone no.</p>

Feature	Operation
<p>Timed Reminder</p> <p>You can receive an alarm at your telephone to remind you of a meeting, appointment or as a wake-up call.</p> <p>The alarm can occur either once or daily (every day until canceled) at a preset time. When you go off-hook to answer, you will hear a special dial tone or prerecorded message.</p> <p>Also, you can confirm the current status of the Time Service on the display.</p>	<p>To set</p> <p>* 7 6 0 1 + hour/minute + 0 (AM)/ 1 (PM) + 0 (once)/ 1 (daily)</p> <p>–or–</p> <p>* 7 6 0 1 + hour/minute + 0 (once)/ 1 (daily)</p> <p>To cancel</p> <p>* 7 6 0 0</p> <p>To confirm</p> <p>Feature key screen¹ +  (TRANSFER) several times</p>
<p> Time Service Mode Control</p> <p>The manager extension or the preprogrammed extension can change the time mode (Day, Lunch, Break or Night).</p> <p>There are two methods (Automatic or Manual) of changing the time modes.</p>	<p>To change the time mode</p> <p>* 7 8 0 + 0 (Day)/ 1 (Night)/ 2 (Lunch)/ 3 (Break)</p> <p>To select the time service switching mode (Automatic/Manual)</p> <p>Feature key screen¹ + [Time Service Switching Mode (Automatic/Manual)]</p>
<p>Trunk Answer From Any Station (TAFAS)</p> <p>You can be notified of incoming outside calls through an external speaker. These calls can be answered from any extension.</p>	<p>* 4 2 + speaker no. (1 digit)</p>
<p>Two-way Record</p> <p>You can record a conversation into your mailbox while talking on the phone.</p> <p></p> <ul style="list-style-type: none"> Recording Calls (Two-way Recording) (Page 72) 	<p>Feature key screen¹ + [Two-way Record]</p>
<p>Two-way Transfer</p> <p>You can record a conversation into another mailbox while talking on the phone.</p>	<p>Feature key screen¹ + [Two-way Transfer] + [DSS]</p>
<p>One-touch Two-way Transfer</p> <p>You can record a conversation into another mailbox with one-touch while talking on the phone.</p>	<p>Feature key screen¹ + [One-touch Two-way Transfer]</p>

Feature	Operation
<p>Walking Extension You can exchange the settings set at another extension with your own settings.</p> <p>Notice</p> <ul style="list-style-type: none"> After you have exchanged the settings between extensions, the KX-NT400 must be restarted for the change to take effect. See "Manual Restarting (System Reset) (Page 168)". 	<p>    + your extension no. + extension PIN</p>

*1 Depending on your settings, how you access this screen will differ.

- If the **Calls** screen is set to Line Buttons mode:
→ Press the **Calls** tab.
- If the **Calls** screen is set to Call List mode:
→ Press  + **Feature**.

For details about the **Calls** screen, see "Calls Screen (Page 37)".

Customizing the Telephone

Contact List

You can customize the contacts that appear in your local directory on the **Contacts** screen. You can create contacts for people, doorphones, and sensors.



There are 4 ways to add new contacts to the list:

- Adding entries manually
See "Adding a New Contact (Page 108)"
- Adding entries from the call log
See "Adding a Contact from a Call Log (Page 108)"
- Adding entries from the system speed dialing directory and the extension directory
See "Adding a Contact from the PBX (Page 109)".
- Adding entries from an LDAP directory
See "Adding a Contact from an LDAP Directory (Page 109)"

!! Usage tips

- You can add up to 300 personal contacts.
- For details about the **Contacts** screen, see "Contacts Screen (Page 32)".
- You can select which directories are displayed on the **Contacts** screen. For details, see "Directory List Select Settings (Page 115)".

Adding a New Contact

You can add new personal contacts from the **Contacts** screen.

1. On the **Contacts** screen, make sure the local directory is displayed.
2. Press .

3. On the top of the window, select the type of contact you want to add:



- **Phone:** Add a contact, with up to 3 telephone numbers
- **Door:** Add a doorphone
- **Sensor:** Add a sensor

You can enter the information for only 1 type of contact.

4. Enter the information for the contact.
For details about the fields, see "Details for Contacts (Page 109)".
5. Press **OK**.

!! Usage tips

- To make a call from the contact list, see "Making a Call from the Contact List (Page 63)".

Adding a Contact from a Call Log

You can add new personal contacts from the **Call Log** screen.

1. On the **Call Log** screen, select the call log you want to add a contact from.

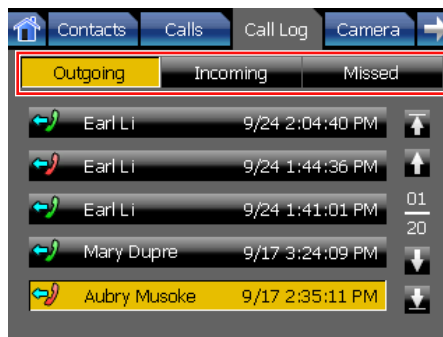

- **Outgoing:** Select from outgoing calls
- **Incoming:** Select from incoming calls

- **Missed:** Select from missed calls
2. Select the entry with the information that you want to add.
 3. Press **Add to Directory**.



The **Add Contact** window appears. The phone number and name (if available) from the entry will be filled in.

4. Enter any additional information as necessary. For details about the fields, see "Details for Contacts (Page 109)".
5. Press **OK**.

!! Usage tips

- You can delete the call log entry by pressing .

Adding a Contact from the PBX

You can add new personal contacts from the system speed dialing directory and the extension directory.

1. On the **Contacts** screen, make sure the local directory is displayed.
2. Select the contact you want to add from the system speed dialing directory or the extension directory.

Note

- To display the system speed dialing directory and extension directory, the corresponding check boxes have to be selected in the **Directory List Select** settings. See "Directory List Select Settings (Page 115)".
3. Press .
 4. Fill in the fields as necessary. For details about the fields, see "Details for Contacts (Page 109)".
 5. Press **OK**.

Adding a Contact from an LDAP Directory

You can add new personal contacts from an LDAP directory.

1. On the **Contacts** screen, make sure the LDAP directory is displayed.
2. Select the contact you want to add.
3. Press .
4. Fill in the fields as necessary. For details about the fields, see "Details for Contacts (Page 109)".
5. Press **OK**.

Editing a Contact

You can edit the information for personal contacts in the local directory.

1. On the **Contacts** screen, make sure the local directory is displayed.
2. Select the contact you want to edit.
3. Press .
4. Edit the information if necessary, and then press **OK**. For details about the fields, see "Details for Contacts (Page 109)".

!! Usage tips

- To edit contacts in the system speed dialing directory, extension directory, or an LDAP directory, first add them to your personal contacts.

Deleting a Contact

You can delete contacts from your personal directory. You cannot delete entries from the LDAP directory.

1. On the **Contacts** screen, make sure the local directory is displayed.
2. Select the contact you want to delete.
3. Press .
4. On the confirmation dialog window, press **Yes**.

Details for Contacts

This section explains the fields for the different types of contacts.

Phone

Use the **Phone** contact type for people or organizations.

Page 1/4—Basic Information

Name (required)

Enter the name of the contact.

- Maximum 32 characters

Company Name

Enter the name of the contact's company.

- Maximum 64 characters

Department

Enter the department the contact works in.

- Maximum 64 characters

Page 2/4—Contact Information

Phone Number (Office)

Enter the contact's office phone number. Use this field for extension numbers within your organization.

- Maximum 64 digits
- Allowed characters: *, #, P (pause), 0–9

Phone Number (Mobile)

Enter the contact's mobile phone number.

- Maximum 64 digits
- Allowed characters: *, #, P (pause), 0–9

Phone Number (Home)

Enter the contact's home phone number.

- Maximum 64 digits
- Allowed characters: *, #, P (pause), 0–9

Note

- When you are creating a contact with the type Phone, you must enter a value for at least one phone number.

Page 3/4—Camera Information 1

Camera Address

Enter the IP address of the contact's camera. Press **Test** to verify the connection to the camera.

- Must be a valid IP address

Camera Login Code

Enter the login code for the contact's camera.

- Maximum 15 characters

Camera Password

Enter the login password for the contact's camera.

- Maximum 15 characters

Page 4/4—Camera Information 2

Camera HTTP Port Number

Enter the port number to that the camera uses for HTTP communication.

- Default value: 80
- Value range: 1–65535

Camera Codec

Select the codec that the contact's camera uses to encode video.

- Select **Motion JPEG** or **MPEG4**.
- Default value: **Motion JPEG**

Camera RTSP Port Number (MPEG4 Only)

Enter the port number that the camera uses for RTSP communication. This setting is only necessary if the camera uses the MPEG4 codec.

- Default value: 554
- Value range: 1–65535

Note

- Consult your administrator to obtain the correct values for the camera settings.

Door

Use the **Door** contact type for doorphones.

Page 1/3—Basic Information



Door Phone Name (required)

Enter the name to assign for the door phone.

- Maximum 32 characters

Door Phone Number (required)

Enter the number of the doorphone.

- Maximum 2 digits
- Allowed characters: *, #, P (pause), 0–9

Note

- If you enter only 1 digit in **Door Phone Number**, a 0 is added to the beginning of the number automatically. For example, "5" is changed to "05".
- Valid doorphone numbers vary according to the connected PBX.

Page 2/3—Camera Information 1

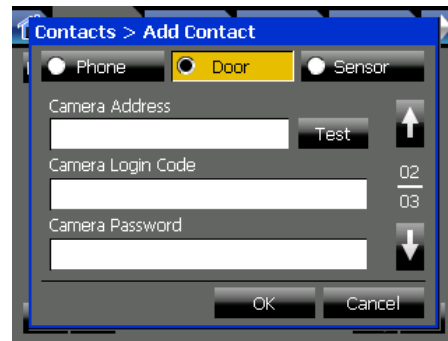

Camera Address

Enter the IP address of the door's camera. Press **Test** to verify the connection to the camera.

- Must be a valid IP address

Camera Login Code

Enter the login code for the door's camera.

- Maximum 15 characters

Camera Password

Enter the login password for the door's camera.

- Maximum 15 characters

Page 3/3—Camera Information 2



Camera HTTP Port Number

Enter the port number that the camera uses for HTTP communication.

- Default value: 80
- Value range: 1–65535

Camera Codec

Select the codec that the door's camera uses to encode video.

- Select **Motion JPEG** or **MPEG4**.
- Default value: **Motion JPEG**

Camera RTSP Port Number (MPEG4 Only)

Enter the port number that the camera uses for RTSP communication. This setting is only necessary if the camera uses the MPEG4 codec.

- Default value: 554
- Value range: 1–65535

Note

- Consult your administrator to obtain the correct values for the camera settings.

Sensor

Use the **Sensor** contact type for sensors, such as motion sensors, that are connected to the PBX.

Page 1/3—Basic Information

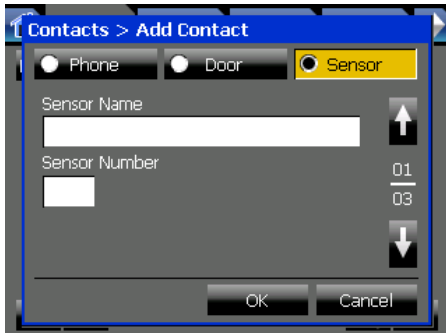

Sensor Name (required)

Enter the name to assign for the sensor.

- Maximum 32 characters

Sensor Number (required)

Enter the number of the sensor.

- Maximum 2 digits
- Allowed characters: *, #, P (pause), 0–9

Note

- If you enter only 1 digit in **Sensor Number**, a 0 is added to the beginning of the number automatically. For example, "5" is changed to "05".
- Valid sensor numbers vary according to the connected PBX.

Page 2/3—Camera Information 1

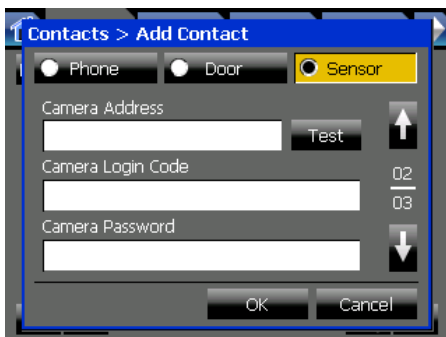

Camera Address

Enter the IP address of the sensor's camera. Press **Test** to verify the connection to the camera.

- Must be a valid IP address

Camera Login Code

Enter the login code for the sensor's camera.

- Maximum 15 characters

Camera Password

Enter the login password for the sensor's camera.

- Maximum 15 characters

Page 3/3—Camera Information 2



Camera HTTP Port Number

Enter the port number that the camera uses for HTTP communication.

- Default value: 80
- Value range: 1–65535

Camera Codec

Select the codec that the sensor's camera uses to encode video.

- Select **Motion JPEG** or **MPEG4**.
- Default value: **Motion JPEG**

Camera RTSP Port Number (MPEG4 Only)

Enter the port number that the camera uses for RTSP communication. This setting is only necessary if the camera uses the MPEG4 codec.

- Default value: 554
- Value range: 1–65535

Note

- Consult your administrator to obtain the correct values for the camera settings.

User Options

This section explains the settings available in **User Options** on the **Options** tab.

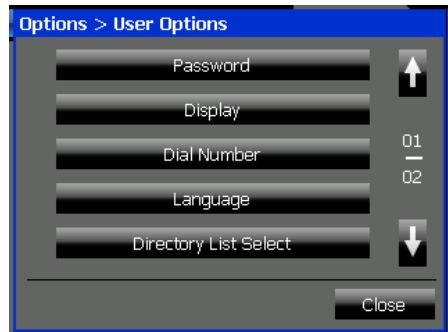

User options are settings that modify the appearance and behavior of normal operation screens, such as the **HOME** screen, **Contacts** screen, **Portal** screen, etc. Changing these settings allow you to customize the KX-NT400 to meet your work habits.

Note

- You can edit the settings in **User Options** only when the KX-NT400 is idle.

Password Settings

The Password settings allow you to activate the Application Lock feature and set the Application Lock password. When the Application Lock feature is enabled, you can set the Application Lock from the **HOME** screen.

The password is used to cancel the Application Lock once you have set it.

To access the Password settings

- Press the **Options** tab > **User Options** > **Password**.
- Configure the settings as desired.
See "Details for Password Settings (Page 113)".
- Press **OK**.

!! Usage tips

- For details about using the Application Lock, see "Locking Operations (Application Lock) (Page 75)".

Details for Password Settings



Application Lock

Select whether to enable the Application Lock feature.

- Default: **Don't use**

Current Password

When you are changing the password, enter the current password in this box.

New Password

When you are changing the password, enter the new password in this box.

- Maximum 16 characters

Verify Password

When you are changing the password, enter the new password again in this box.

- Maximum 16 characters

CAUTION

To avoid unauthorized access to locked screens:

- Set a password when you enable the Application Lock feature.
- Set a password that is random and cannot be easily guessed.
- Change the password regularly.

Display Settings

The Display settings allow you to customize the settings for the touch screen, such as the display color and brightness. You can also set whether the display provides audio feedback, calibrate the touch screen, and select the mode for the **Calls** screen.

To configure the Display settings

- Press the **Options** tab > **User Options** > **Display**.
- Configure the settings as desired.
See "Details for Display Settings (Page 114)".
- Press **OK**.

Note

- If you change the **Display Color** or **Select Calls Screen** settings, the KX-NT400 automatically restarts after you press **OK**.

Details for Display Settings

Page 1/3

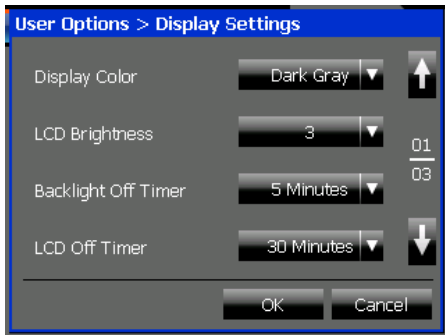

Display Color

Press the drop-down list to select the display color.

LCD Brightness

Press the drop-down list to select the brightness for the display.

Backlight Off Timer

Press the drop-down list to select the number of minutes before the LCD dims. Selecting a shorter time reduces the KX-NT400's power consumption.

LCD Off Timer

Press the drop-down list to select the number of minutes before the LCD turns off. Selecting a shorter time reduces the KX-NT400's power consumption.

Page 2/3

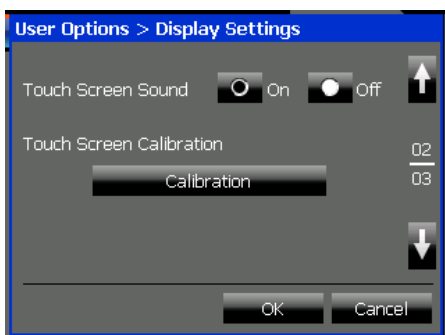

Touch Screen Sound

Select whether the KX-NT400 gives audio feedback when you perform operations on the screen.

- Default: **Off**

Touch Screen Calibration

Press **Calibration** to calibrate the touch screen. Follow the on-screen instructions to perform calibration.

Calibrating the screen ensures that the locations you press on the screen match the displayed controls.

Page 3/3

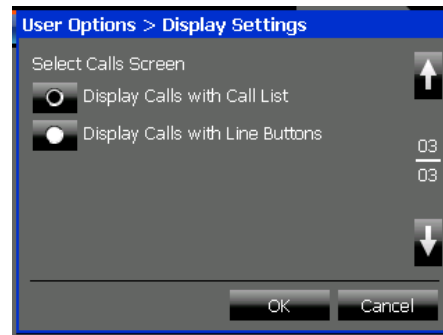

Select Calls Screen

Select the display mode for the **Calls** screen.

- **Display Calls with Call List:** Display the active calls in a list. For details, see "Calls Screen in Call List Mode (Page 40)".
- **Display Calls with Line Buttons** (default): Display a screen that is similar to a conventional IP-PT. For details, see "Calls Screen in Line Buttons Mode (Page 37)".

Dial Number Settings

The Dial Number settings allow you to enter the voice mail system's extension number, and the default number to redirect calls to.

To configure the Dial Number settings

1. Press the **Options** tab > **User Options** > **Dial Number**.
2. Configure the settings as desired. See "Details for Dial Number Settings (Page 115)".
3. Press **OK**.

!! Usage tips

- For details about redirecting and voice mail features, see the following sections:
 - Redirecting Calls (Page 68)
 - Transferring a Call (Call Transfer) (Page 71)

- Recording Calls (Two-way Recording) (Page 72)
- Checking New Messages (Page 76)
- Accessing Voice Mail (Page 77)

Details for Dial Number Settings

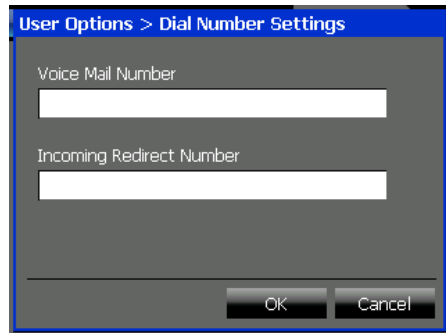

Voice Mail Number

If your organization uses voice mail, enter the voice mail system's extension number.

- Default: If a voice mail extension number is specified in the PBX, the first specified number is displayed.
- Maximum 5 digits
- Allowed characters: *, #, P (pause), 0–9

Incoming Redirect Number

Enter the destination (extension or outside number) to use as the default destination for redirecting incoming calls.

- Maximum 32 digits
- Allowed characters: *, #, P (pause), 0–9

Language Settings

The Language settings allow you to select the display language.

You can select from a list of built-in languages, or, if you have an SD memory card with additional language files, you can select one of those languages.

To select the display language

1. Press the **Options** tab > **User Options** > **Language**.
2. Press the drop-down list to select the display language.
See "Details for Language Settings (Page 115)".
3. Press **OK**.

Notice

- If you have modified any of the preset presence settings, changing the language resets them to their default settings.

Note

- If you change the Language settings, the KX-NT400 automatically restarts after you press **OK**.

Details for Language Settings



Language

Press the drop-down list to select the display language.

- Default: **English-US**
- Built-in languages: English-US, English-UK, French, French-CA, German, Spanish, Italian, Portuguese, Russian, Ukrainian

Another

Select **Another** and then press  to select the display language from an SD memory card.

Language files must be stored in the following directory on the SD memory card:

```
\private\meigroup\pcc\pbxpt\nt400
```

Note

- This language setting is not effective for the sub-display on the **Calls** screen, **Feature Key** screen (in Call List mode), or **Programming** screen. To change the language settings for the sub-display, see "PT Programming (Page 125)".
- For details about obtaining additional language files, consult your dealer.

Directory List Select Settings

The Directory List Select settings allow you to select which directory lists are displayed on the **Contacts** screen.

To configure the Directory List Select settings

1. Press the **Options** tab > **User Options** > **Directory List Select**.
2. Select the directories you want to display on the **Contacts** screen.
See "Details for Directory List Select Settings (Page 116)".
3. Press **OK**.

!! Usage tips

- You can refresh the system speed dialing directory and the extension directory information from the PBX by pressing **Refresh**.
- For details about the **Contacts** screen, see "Contacts Screen (Page 32)".

Details for Directory List Select Settings

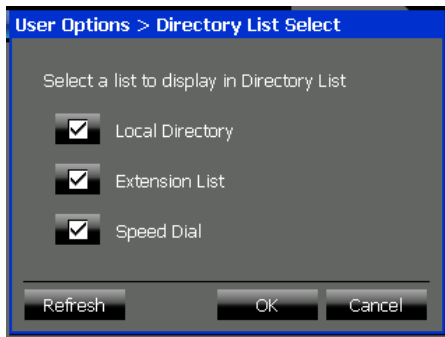

Local Directory

Select this to display the local directory (your personal directory).

Extension List

Select this to display the extension directory from the PBX.

Speed Dial

Select this to display the system speed dialing directory from the PBX.

Note

- You must select at least one directory.

IP Camera Settings

The IP Camera settings allow you to register, edit, and delete network cameras.

You can register a maximum of 20 cameras.

Registered cameras can be viewed on the **Camera** screen.

To register or edit a camera

1. Press the **Options** tab > **User Options** > **IP Camera**.

To register a new camera

- a. Press .

To edit a camera

- a. Select a camera, and then press .
2. Enter the camera's information as necessary.
See "Details for IP Camera Settings (Page 116)".
 3. Press **OK**.

To delete a camera

1. Press the **Options** tab > **User Options** > **IP Camera**.
2. Select a camera, and then press .
3. On the confirmation dialog window, press **Yes**.

!! Usage tips

- For details about network camera features, see "Network Camera (Page 81)".
- For details about the **Camera** screen, see "Camera Screen (Page 49)".

Details for IP Camera Settings

Page 1/3

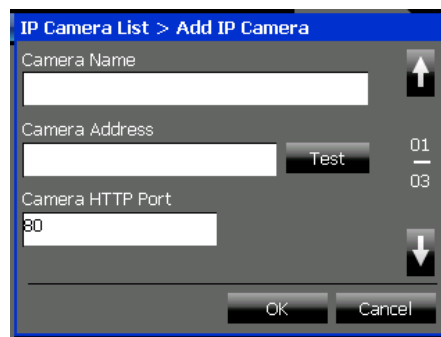

Camera Name (required)

Enter the name to display for the camera in the camera list.

- Maximum 20 characters

Camera Address (required)

Enter the IP address of the camera. Press **Test** to verify the connection to the camera.

- Must be a valid IP address

Camera HTTP Port (required)

Enter the port number that the camera uses for HTTP communication.

- Default value: 80
- Value range: 1–65535

Page 2/3
Login Code

Enter the login code for the camera.

- Maximum 15 characters

Password

Enter the password for the camera.

- Maximum 15 characters

Page 3/3
Codec

Select the codec that the camera uses to encode video.

- Select **Motion JPEG** or **MPEG4**.
- Default value: **Motion JPEG**

Camera RTSP Port (MPEG4 Only)

Enter the port number that the camera uses for RTSP communication. This setting is only necessary if the camera uses the MPEG4 codec.

- Default value: 554
- Value range: 1–65535

IP Camera Selection Buttons Settings

The IP Camera Selection Buttons settings allow you to assign up to 4 cameras to the buttons that appear at the bottom of the Camera screen. These buttons let you access the assigned cameras with one touch.

To assign cameras to the selection buttons

1. Press the **Options** tab > **User Options** > **IP Camera Selection Buttons**.
2. Assign cameras to the buttons as desired. See "Details for IP Camera Selection Buttons Settings (Page 117)".
3. Press **OK**.

!! Usage tips

- For details about the selection buttons screen, see "Selecting Cameras to View (Page 81)".
- For details about the **Camera** screen, see "Camera Screen (Page 49)".

Details for IP Camera Selection Buttons Settings

Camera Button 1–Camera Button 4

Press the drop-down list for the corresponding button to select a camera. You can select from currently registered cameras.

Portal Settings

The Portal settings allow you to set a list of up to 50 intranet Web pages that you can access from the **Portal** screen. You can also specify one of the pages as the homepage.

To manage the intranet Web page list

1. Press the **Options** tab > **User Options** > **Portal**.
2. Use the buttons along the top of the window to manage the Web page list:

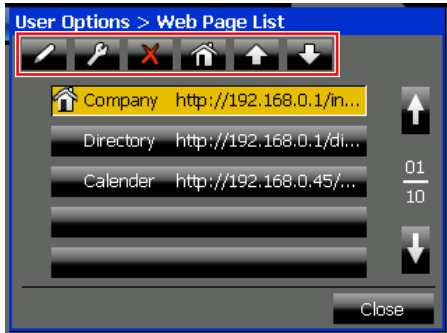

Button	Description
	Add a new Web page. See "Details for Web Page List Settings (Page 118)".
	Edit the selected Web page. See "Details for Web Page List Settings (Page 118)".
	Delete the selected Web page.
	Set the selected Web page as the homepage.
	Move the selected Web page up the list.
	Move the selected Web page down the list.

3. Press **Close**.

!! Usage tips

- For details about features of the portal, see "Portal (Web Browser) (Page 84)".
- For details about the **Portal** screen, see "Portal Screen (Page 54)".

Note

- If you import Portal settings, no page will be set as the homepage.

Details for Web Page List Settings

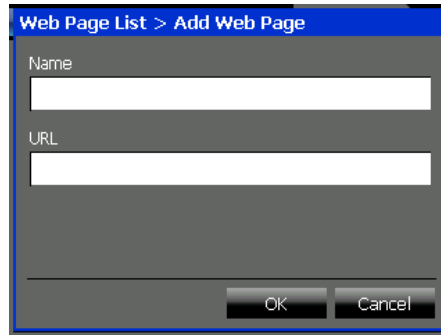

Name (required)

Enter the name to display for the intranet Web page in the list.

- Maximum 32 characters

URL (required)

Enter the URL of the intranet Web page.

- Maximum 256 characters

Note

- The KX-NT400 does not support the DNS (Domain Name Server) protocol. Therefore, URLs cannot contain domains such as "www.example.com". You can only use URLs with IP addresses, such as "192.168.0.1/nt400/list.html". For details, consult your administrator.

Presence Settings

The Presence settings allow you to customize your presence buttons (e.g., "Available" or "In a Meeting"). In addition to the 7 preset presence statuses, you can add up to 8 new presence statuses. You can also modify the existing presence statuses.

You can assign Call Forwarding/Do Not Disturb settings and a feature number to a presence status. When you select that presence status, the Call Forwarding/Do Not Disturb settings are applied and the feature number is executed.

To customize the presence buttons

1. Press the **Options** tab > **User Options** > **Presence**.
2. Select the presence status you want to configure. To add a new presence status, select a blank item.

To add or modify the selected presence status

- a. Press .
See "Details for Presence List Settings (Page 119)".

To delete the selected presence status

- a. Press .
 - b. On the confirmation dialog window, press **Yes**.
3. Press **Close**.

!! Usage tips

- You can select your presence status and Call Forward/Do Not Disturb settings from the **HOME** screen. For details, see "Presence Status Setting (Page 78)".
- You can assign a feature number to a presence status. For details about feature numbers, see "PBX Feature List (Page 89)".

Presence Setting Example 1

When you are away from your desk, you probably still want to receive phone calls. Therefore, you can have calls to your extension automatically forwarded to your mobile phone (0-123-456) when you select the "Not at My Desk" presence.

To do this, you would configure the settings as follows:

Modify screen (see "Details for Presence List Settings 2/2 (Page 120)")

Setting	Value
Forward / DND Settings	Selected

FWD/DND Settings screen (see "Details for Call Forwarding/Do Not Disturb Settings (Page 120)")

Setting	Value
For both external calls and internal calls	Selected
For external calls	Always (All)
Dial	0123456

Presence Setting Example 2

In addition to forwarding your calls while you are away, you might want to keep others from making calls from your phone. This can be accomplished by assigning the Extension Dial Lock feature number to the "Not at My Desk" presence.

To do this, configure the settings as follows:

Modify screen (see "Details for Presence List Settings 2/2 (Page 120)")

Setting	Value
Feature Number	*771

Note

- For details about Extension Dial Lock, see "Extension Dial Lock (Page 97)".

Details for Presence List Settings

Page 1/2



Button Name (required)

- Enter the name to display on the presence button.
 - Maximum 16 characters

Presence

- Select this check box to set your presence message when this presence status is selected. If you do not select this check box, your presence does not change when you select this presence status.
- **Same as Button Name** (default)
Assign the presence message to be the same as the name assigned in **Button Name**.
 - **Available**
Set your presence to "Available".
 - **Custom**
Enter a custom presence message. The presence message that you enter will be displayed to other users.

Page 2/2

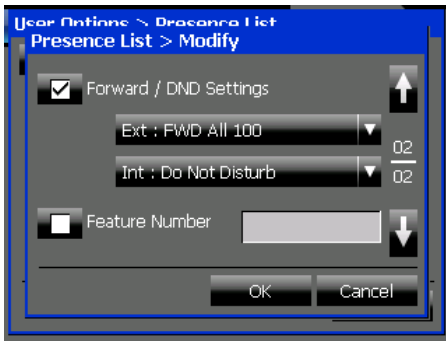

Forward / DND Settings

Select this check box to assign Call Forwarding/Do Not Disturb settings when you select this presence status. Press one of the drop-down lists to configure the Call Forwarding/Do Not Disturb settings. For details, see "Details for Call Forwarding/Do Not Disturb Settings (Page 120)".

Feature Number

Select this check box to execute a feature number when you select this presence status. Enter a feature number in the text box. For example, when you select "Gone Home", you could have the feature number executed for logging out of a group. For details about features numbers, see "PBX Feature List (Page 89)".

Details for Call Forwarding/Do Not Disturb Settings

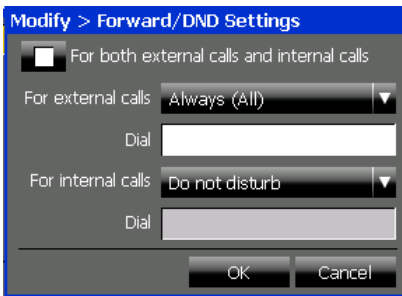

For both external calls and internal calls

Select this check box if you want to apply the same settings to both external and internal calls.

For external calls/For internal calls

Press the drop-down list to select when to forward external and internal calls:

- **Always (All):** Forward all calls.
- **Busy:** Only forward calls when you are busy (i.e., on a call).

- **No answer:** Only forward calls when you do not answer the phone after a set amount of time.¹
- **Busy/No answer:** Forward calls when you are busy or do not answer after a set amount of time.¹
- **Do not disturb:** Reject incoming calls.
- **Not Assigned:** Do not forward or reject calls.

Dial

If you selected a forwarding destination other than Do not disturb or Not Assigned, enter the destination (extension or outside number) to forward calls to.

¹ The no answer time can be set using a feature number. For details, see "Call Forwarding (FWD) (Page 91)".

Administrator Options

This section explains some of the settings available in **Administrator Options** on the **Options** tab.

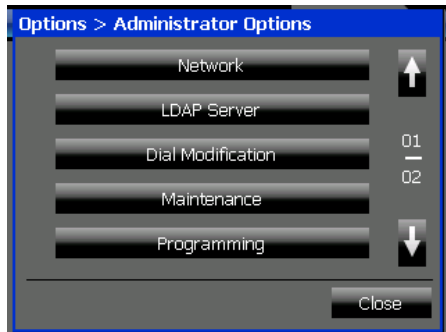

Administrator options are settings that modify network settings and telephone operations. Consult your administrator for details about the correct settings.

The following settings are explained in this section:

- LDAP Server Settings (Page 121)
- Dial Modification Settings (Page 122)

See the following sections for details about the other items on this screen:

- For details about **Network**, see "Setting Up the KX-NT400 (Page 157)".
- For details about **Maintenance**, see "Data Maintenance (Page 166)".
- For details about **Programming**, see "PT Programming (Page 125)".
- For details about **Error Log**, see "Error Messages (Page 192)".

LDAP Server Settings

The LDAP Server settings allow you to specify the LDAP servers that you can access on the **Contacts** screen.

You can add, edit, and delete LDAP server settings.

To configure LDAP Server settings

1. Press the **Options** tab > **Administrator Options** > **LDAP Server**.
2. Select an operation:

To add a new LDAP server

- a. Press . See "Details for LDAP Server Settings (Page 121)".

To edit an LDAP server's configuration

- a. Select an LDAP server.
- b. Press . See "Details for LDAP Server Settings (Page 121)".

To delete an LDAP server

- a. Select an LDAP server.
 - b. Press .
 - c. On the confirmation dialog window, press **Yes**.
3. Press **Close**.

!! Usage tips

- For details about selecting and displaying LDAP server directories, see "Making a Call from the Contact List (Page 63)".
- For details about the **Contacts** screen, see "Contacts Screen (Page 32)".

Details for LDAP Server Settings

Page 1/2

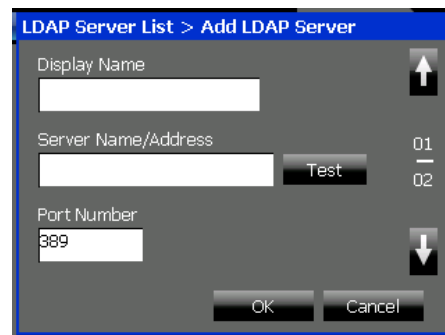

Display Name (required)

Enter the name to display for the LDAP server.

- Maximum 20 characters

Server Name/Address (required)

Enter the IP address of the LDAP server.

Press **Test** to verify the connection to the LDAP server.

- Must be a valid IP address

Port Number (required)

Enter the port number that the LDAP server uses for communication.

- Value range: 389, 636, 1024–65535

Page 2/2

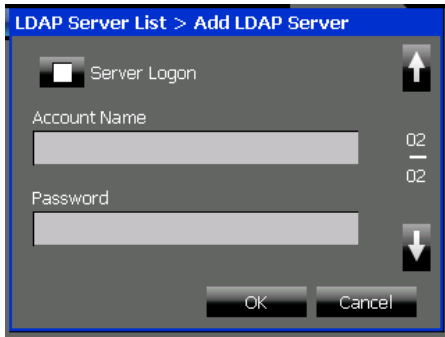

Server Logon

Select this check box if the LDAP server requires authentication.

Account Name

Enter the account name for logging in to the LDAP server.

- Maximum 128 characters

Password

Enter the password for logging in to the LDAP server.

- Maximum 128 characters

Dial Modification Settings

The Dial Modification settings allow you to configure how phone numbers are modified when making an outside call.

When you dial an outside number¹, it is checked against the dial modification table. If the leading digits in the number match an entry in the table, then the number is modified before being sent to the telephone company. This feature is useful for adding dialing prefixes for international calls and removing area codes from local phone numbers.

Note

- The Dial Modification settings are not applied to phone numbers dialed directly using the dial keys.

¹ An outside number is determined by its number of digits. If the number of digits in a dialed number is equal to or greater than the **Min. number of digits of an outside line**: setting, the dialed number is treated as an outside call.

To configure Dial Modification settings

1. Press the **Options** tab > **Administrator Options** > **Dial Modification**.

2. Configure the dial modification settings. See "Details for Dial Modification Settings (Page 122)".
3. Press **OK**.

Setting Example

This example illustrates how different numbers are modified for a specific configuration.

Dial Modification Settings

	Digits to Remove	Digits to Add
1	+8192	
2	+81	0
3	+	001
4	092	

Modification Results

- Dialed number: +81-92-123-4567
Result: 123-4567
The dialed number matches row 1. The matching digits (+8192) are removed, and no digits are added.
- Dialed number: +44-66-111-4444
Result: 001-44-66-111-4444
The dialed number matches row 3. The matching digit (+) is removed, and the specified digits (001) are added.
- Dialed number: 092-111-8888
Result: 111-8888
The dialed number matches row 4. The matching digits (092) are removed, and no digits are added.

Details for Dial Modification Settings

Page 1/4



Access Code for International Call

Enter the access code for making international calls from your country/area.

- Maximum 8 digits

International area code

Enter the international area code for your country/area.

- Maximum 3 digits

Min. number of digits of an outside line:

Enter the minimum number of digits for a public telephone number (outside call).

- Value range: 1–32

Remove (0)

Select this check box to remove "(0)" from a phone number. "(0)" is often used for international numbers to indicate that it is not necessary when dialing internationally.

For example, "+44-(0)123-4567" means:

- Number when dialing internationally:
44-123-4567
- Number when dialing locally:
0123-4567

Page 2/4–3/4

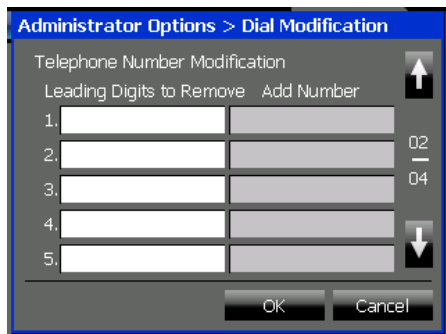

Leading Digits to Remove 1–10

Enter the digits to remove from the beginning of a dialed telephone number. This can be used to remove the local area code from a telephone number, or international prefixes.

A telephone number is compared with the entries starting with entry 1, and is modified according to the first entry it matches.

- Maximum 16 digits or symbols
- Allowed characters: +, *, #, P (pause), 0–9
- Default values:

If **International area code** is "1":

- Entry 7: "0"
- Entry 8: "1"
- Entry 9: "+1"
- Entry 10: "+"

If **International area code** is "7":

- Entry 7: "0"
- Entry 8: "8"

- Entry 9: "+7"
- Entry 10: "+"

For all other values of **International area code**:

- Entry 9: "+[**International area code**]"
- Entry 10: "+"

Add Number 1–10

Enter the digits to add to the beginning of a dialed telephone number after removing leading digits. When a telephone number matches an entry in **Leading Digits to Remove**, the specified digits are removed, and then the corresponding digits in **Add Number** are prepended to the telephone number.

- Maximum 8 digits or symbols
- Allowed characters: *, #, P (pause), 0–9
- Default values:

If **International area code** is "1":

- Entry 7: "0"
- Entry 8: "1"
- Entry 9: "1"
- Entry 10: "011"

If **International area code** is "7":

- Entry 7: "0"
- Entry 8: "8"
- Entry 9: "8"
- Entry 10: "810"

For all other values of **International area code**:

- Entry 9: "0"
- Entry 10: "[**Access Code for International Call**]"

Page 4/4

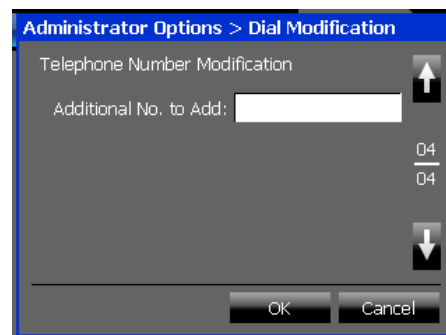

Additional No. to Add:

Enter any additional digits to add to the beginning of a dialed number. These digits are added to every outside call.

- Maximum 8 digits or symbols

Customizing the Telephone

- Allowed characters: *, #, P (pause), 0–9
- Default values:
 - If **International area code** is 1: "1"
 - If **International area code** is 7: "8"
 - For all other values of **International area code**: (blank)

PT Programming

By using programming mode, you can customize the KX-NT400 beyond the settings that are available on the **Options** tab.

You can access programming mode on the **Programming** screen. In programming mode, most operations are performed using the Navigator key and dial keys.

To program the KX-NT400 in programming mode

1. Press the **Options** tab > **Administrator Options** > **Programming**.

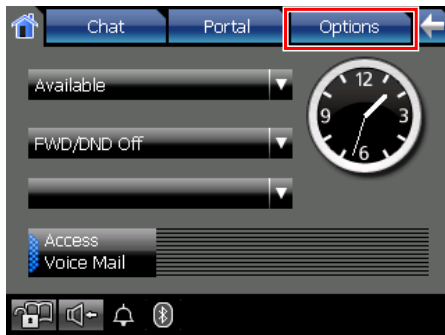

2. On the **Programming** screen, press **PROG**.



3. Enter the input for the feature you want to set, and then press  (**ENTER**).
4. See "Feature Programming (Page 126)".
5. Enter the parameters for the feature as necessary.
6. See "Feature Programming (Page 126)".
7. Press **EXIT** to exit.

Note

- To continue programming other features, repeat the above procedure from step 2.
- During programming, you can only use the dial keys to enter characters.
- Pressing **P** allows you to access buttons normally found on ordinary IP-PTs as hard keys.

!! Usage tips



- Once you enter programming mode (step 2 in the above procedure), you can also use the Navigator key to scroll through the programmable features and to select parameters.
- You can also access programming mode on the **Calls** screen or the **Feature Key** screen (in Call List mode). For details, see "Calls Screen in Line Buttons Mode (Page 37)" and "Feature Key Screen (Page 55)".

Feature Programming



The following table explains the features that are available in programming mode and how to program them.

Note

- The default values are displayed in **bold**.

Item	Programming Input	Selection & Parameter	
Display Language Selection Note Changing this setting only affects the language used in the sub-display.	0 2	Select the language via the Language settings.	
Display Switching Mode	0 3	Set whether the call duration for outside calls is displayed on the Calls screen in Line Buttons mode. If the Calls screen is set to Call List mode, the duration is always displayed for both internal and external calls, regardless of this setting.  <ul style="list-style-type: none"> Calls Screen (Page 37) 	
Speed Dial	1 0	Store frequently dialed numbers in your contact list.  <ul style="list-style-type: none"> Contact List (Page 108) 	
Hot Line Would you like to dial a preset number simply by going off-hook?	1 1	desired no. (max. 32 digits)	
	1 2	0	<input type="checkbox"/> Do not use
		1	<input type="checkbox"/> Use
Calling Line Identification Restriction (CLIR) Should you prevent your number being displayed on the called party's telephone?	1 3	0	<input type="checkbox"/> No—Allows your number to be displayed
		1	<input type="checkbox"/> Yes—Prevent your number being displayed
Calling/Connected Line Identification Presentation (CLIP/COLP) Which number should be displayed on the called and calling party's telephone?	1 4	0	Caller ID assigned to your extension
		1	Caller ID assigned on the CO line being used

Item	Programming Input	Selection & Parameter	
<p>Preferred Line Assignment—Outgoing Which do you prefer to seize when you go off-hook to make calls?</p>	<p>1 9</p>	0	<input type="checkbox"/> No line
		1	<input type="checkbox"/> An idle CO line
		<p>2 + CO button no. (01–48) –or– [] (Flexible button)</p>	<input type="checkbox"/> A CO/ICD Group button
		<p>3 –or– [PDN] (PDN button)</p>	<input type="checkbox"/> Intercom (On a PDN extension, an idle PDN button is selected when going off-hook.)
<p>Preferred Line Assignment—Incoming Which line do you prefer to answer when you go off-hook?</p>	<p>2 0</p>	0	<input type="checkbox"/> No line
		1	<input type="checkbox"/> The longest ringing line (when multiple calls arrive)
		<p>2 + CO button no. (01–48)</p>	<input type="checkbox"/> A CO/ICD Group button
		<p>3 –or– [PDN] (PDN button)</p>	<input type="checkbox"/> A PDN button
<p>Alternate Receiving—Ring/Voice How do you prefer to receive an intercom call?</p>	<p>2 1</p>	0	<input type="checkbox"/> Ringing (Tone Call)
		1	<input type="checkbox"/> Directly—The party’s voice is heard without ringing.
		2	<input type="checkbox"/> Ring only—Prohibiting the caller switching to the voice mode.
<p>Forced Answerback Selection Do you prefer to answer a call without going off-hook regardless of the Auto answer setting?</p> <p> Receiving a Call (Page 67)</p>	<p>2 3</p>	0	<input type="checkbox"/> No—Disable
		1	<input type="checkbox"/> Yes—Enable

Item	Programming Input	Selection & Parameter	
Live Call Screening Mode Set Which service do you prefer when a calling party is recording a message in your mailbox?	2 5	0	<input type="checkbox"/> You can monitor the message through the telephone speaker. (Hands-free mode)
		1	<input type="checkbox"/> Only an alarm tone is heard. (Private mode)
LCS Mode Set (After Answering) Would you like to keep recording after answering the call in the LCS mode?	2 6	0	<input type="checkbox"/> No—Stop recording
		1	<input type="checkbox"/> Yes—Keep recording
Automatic Call Waiting* Would you prefer to automatically hear a call waiting tone when you receive a call while already on the phone?	3 0	0	<input type="checkbox"/> No—Off
		1	<input type="checkbox"/> Yes—On
Manual Call Waiting How would you prefer to receive call waiting notifications for intercom calls?	3 1	0	<input type="checkbox"/> No call (Off)
		1	<input type="checkbox"/> Tone (BSS)
		3	<input type="checkbox"/> Voice announcement through the handset (Whisper OHCA)
Call Waiting Tone Type Selection Which type of call waiting tone do you prefer?	3 2	0	<input type="checkbox"/> Tone 1
		1	<input type="checkbox"/> Tone 2
Absent Message Would you like to show a message on the caller's telephone display?	4 0	Set your absent message (presence status) via the HOME screen.  • Presence Status Setting (Page 78)	
Personal Absent Message Creating your personal message	4 1	Create personal absent messages (presence message) via the Presence settings.  • Presence Settings (Page 118)	
Call Forwarding (FWD)/Do Not Disturb (DND) To forward or refuse some or all of your incoming calls	5 0	Set the Call Forwarding/Do Not Disturb status via the HOME screen.  • Call Forwarding/Do Not Disturb (Page 79)	

Item	Programming Input	Selection & Parameter	
FWD N/A Timer To set the timer for "No answer" and "Busy/No answer"	5 3	<input type="text"/> (0–120) seconds (Default: 15 seconds)	
Call Pickup Deny Should you prohibit other people from picking up your calls?	6 0	0	<input type="checkbox"/> No—Allow
		1	<input type="checkbox"/> Yes—Deny
Headset Operation Do you use the headset?	6 1	0	<input type="checkbox"/> No—Headset off
		1	<input type="checkbox"/> Yes—Headset on
Executive Busy Override Deny Do you prohibit other people from joining your conversation?	6 2	0	<input type="checkbox"/> No—Allow
		1	<input type="checkbox"/> Yes—Deny
Paging Deny Would you like to prohibit paging announcements?	6 3	0	<input type="checkbox"/> No—Allow
		1	<input type="checkbox"/> Yes—Deny
Key Pad Tone Set Do you prefer to hear the key pad tone? Note Changing this setting affects key tone for only physical keys and buttons.	6 4	0	<input type="checkbox"/> No—Off
		1	<input type="checkbox"/> Yes—On
Background Music (BGM) Do you want background music through your telephone speaker while on-hook?	6 5	0	<input type="checkbox"/> No—Off
		1 + BGM no. (1 digit)	<input type="checkbox"/> Yes—On
Bluetooth Registration To register a Bluetooth wireless headset on your extension ²	6 6	Pass key (max. 16 digits)	
Bluetooth Removal To cancel the registration of a Bluetooth wireless headset on your extension ²	6 7	Confirm that the ID of your Bluetooth wireless headset is displayed.	

Item	Programming Input	Selection & Parameter	
<p>Extension PIN (Personal Identification Number) To set your extension PIN or change the stored extension PIN</p>	<p>9 0</p>	<p>extension PIN (max. 10 digits) + ENTER/STORE + same extension PIN</p>	<p>To set an extension PIN</p>
		<p>stored extension PIN + new extension PIN (max. 10 digits) + ENTER/STORE + same extension PIN</p>	<p>To change the stored extension PIN</p>
<p>Extension Dial Lock To prevent other people from using your telephone</p> <p><i>This feature is different from the Application Lock.</i></p>	<p>9 1</p>	<p>extension PIN (max. 10 digits) + 0</p>	<p><input type="checkbox"/> To unlock</p>
		<p>extension PIN (max. 10 digits) + 1</p>	<p><input type="checkbox"/> To lock</p>
<p>Display Lock To prevent other people from seeing your personal speed dialing directory, call log, SVM log, and from playing back the voice messages in your message box</p> <p><i>This feature is different from the Application Lock.</i></p>	<p>9 2</p>	<p>extension PIN (max. 10 digits) + 0</p>	<p><input type="checkbox"/> To unlock</p>
		<p>extension PIN (max. 10 digits) + 1</p>	<p><input type="checkbox"/> To lock</p>
<p>One-touch Dialing Assignment Mode Selection Do you prefer to set the One-touch dialing only?</p>	<p># *</p>	<p>0</p>	<p><input type="checkbox"/> No—Normal (Any Flexible buttons can be modified.)</p>
		<p>1</p>	<p><input type="checkbox"/> Yes—Only One-touch dial keys can be modified. However, to modify them, there is no need to enter "2" before the number.</p>

^{*1} This setting applies to both outside and intercom calls. For intercom calls, this feature must be enabled through system programming.
^{*2} Registering and canceling a Bluetooth wireless headset may take time. Please avoid any interruption during that time by, for example, going off-hook.

CAUTION

There is a risk that fraudulent telephone calls will be made if a third party discovers your password (extension PIN).
 The cost of such calls will be billed to the owner/renter of the PBX.
 To protect the PBX from this kind of fraudulent use, we recommend:

1. Keeping your PIN secret.
2. Selecting a complex, random PIN that cannot be easily guessed.

3. Changing your PIN regularly.

Clearing Features

You can reset the following features to their default values:

Features	Default Setting
Display Switching Mode	Automatic
Hot Line	Off
Calling Line Identification Restriction (CLIR)	Allow
Calling/Connected Line Identification Presentation (CLIP/COLP)	Caller ID assigned on your extension
Preferred Line Assignment—Outgoing	Intercom
Preferred Line Assignment—Incoming	The longest ringing line
Alternate Receiving—Ring/Voice	Ringing (Tone Call)
Forced Answerback Selection	Disable
Live Call Screening Mode Set	Hands-free mode
LCS Mode Set (After Answering)	Stop recording
Automatic Call Waiting	On
Manual Call Waiting—Intercom Calls	On (Tone)
Call Waiting Tone Type Selection	Tone 1
Absent Message	Off
Personal Absent Message	Cleared
Call Forwarding (FWD)/Do Not Disturb (DND)—Intercom/Outside Calls	Off
FWD N/A Timer	15 seconds
Call Pickup Deny	Allow
Headset Operation	Headset off
Executive Busy Override Deny	Allow
Paging Deny	Allow
Key Pad Tone Set	On
Background Music (BGM)	Off
Data Line Security	Off
Connected Line Identification Restriction [COLR]	Allow
Log-in/Log-out	Log-in
Message Waiting	Off
Timed Reminder	Cleared

To reset the features

1. Press the **Options** tab > **Administrator Options** > **Programming**.

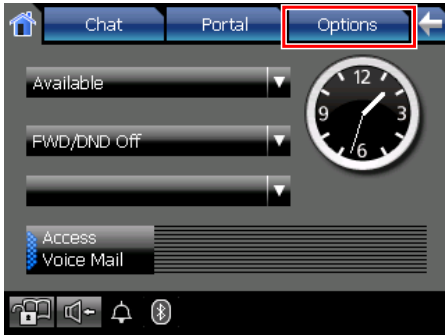

2. On the **Programming** screen, press **PROG**.



3. Using the dial keys, press **# #**.
4. Press **ENTER** (ENTER) 2 times.
5. Press **EXIT**.

!! Usage tips

- You can also reset the features on the **Calls** screen or the **Feature Key** screen (in Call List mode). For details, see "Calls Screen in Line Buttons Mode (Page 37)" and "Feature Key Screen (Page 55)".

Note

- If you do not want the Call Waiting, FWD/DND or Hot Line to be cleared by this feature, please ask your dealer.

Customizing the Flexible Buttons

You can customize the flexible buttons that are displayed on the **Calls** screen or the **Feature Key** screen (in Call List mode) by assigning functions to them. They can then be used to make or receive outside calls or as feature buttons.

You can customize the flexible buttons on the **Programming** screen.

Note

- The flexible buttons work as Single-CO (S-CO) button by default.

Programming Screen



The flexible buttons' lights on the **Programming** screen indicate their status:

Button Name	Light Status	Meaning
FWD/DND	Off	Both features are not set.
	Red on	FWD mode
	Flashing red slowly	DND mode
AUTO ANS/MUTE	Off	Normal
	Red on	Auto Answer ON
INT' (INTERCOM)	Green on	The extension is seized by you.

To customize flexible buttons

- Press the **Options** tab > **Administrator Options** > **Programming**.
- On the **Programming** screen, press **PROG**.



3. Select the page number of the flexible button you want to customize.

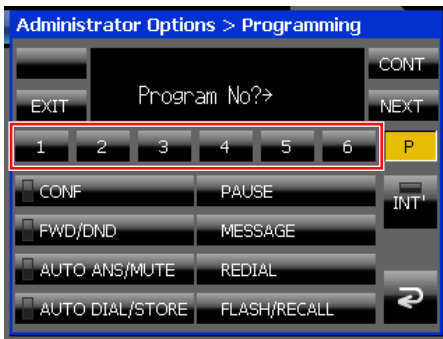

4. Press the flexible button you want to customize.

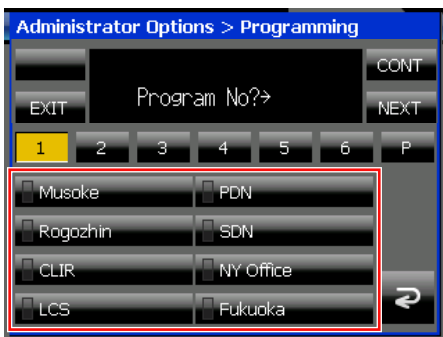



5. Using the dial keys, enter the programming input.
See "Programming Input Table (Page 134)".
6. Press  (ENTER).
7. Using the dial keys, enter a name for the button.
For details on entering characters with the dial keys, see "Entering Characters (Page 145)".
8. To continue programming, repeat the procedure from step 4.
–or–
To exit, press **EXIT**.

!! Usage tips

- In step 5 in the procedure above, you can also use the Navigator key to scroll through the programmable features and to select parameters.
- You can exit the programming procedure at any time by lifting the handset.
- You can also customize the flexible buttons on the **Calls** screen or the **Feature Key** screen (in Call List mode).
For details, see "Calls Screen in Line Buttons Mode (Page 37)" and "Feature Key Screen (Page 55)".

Programming Input Table

The following table explains the features that you can assign to flexible buttons and the input for programming them.

Button	Description & Programming Input
Loop-CO (L-CO)	<p>Used to access an idle CO line for making outside calls. Incoming outside calls from any CO line arrive at this button.</p> <p>Programming Input </p> <p>The L-CO button light shows the current status as follows:</p> <ul style="list-style-type: none"> • Green on: The CO line is seized by you. • Red on: The CO line is busy. <p><Regular Hold mode></p> <ul style="list-style-type: none"> • Flashing green slowly: Your held call • Flashing red: Another extension's held call <p><Exclusive Call Hold mode></p> <ul style="list-style-type: none"> • Flashing green moderately: Your held call
Group-CO (G-CO)	<p>Used to access an idle CO line in a specified CO line group for making outside calls. Incoming calls from CO lines in the assigned CO line group arrive at this button.</p> <p>Programming Input  + CO line group no. (2 digits)</p> <p>The G-CO button light shows the current status as follows:</p> <ul style="list-style-type: none"> • Green on: The CO line is seized by you. • Red on: The CO line is busy. <p><Regular Hold mode></p> <ul style="list-style-type: none"> • Flashing green slowly: Your held call • Flashing red: Another extension's held call <p><Exclusive Call Hold mode></p> <ul style="list-style-type: none"> • Flashing green moderately: Your held call
Single-CO (S-CO) ¹	<p>Used to access a specified CO line for making or receiving outside calls.</p> <p>Programming Input  + CO line no. (3 digits)</p> <p>The S-CO button light shows the current status as follows:</p> <ul style="list-style-type: none"> • Green on: The CO line is seized by you. • Red on: The CO line is busy. <p><Regular Hold mode></p> <ul style="list-style-type: none"> • Flashing green slowly: Your held call • Flashing red: Another extension's held call <p><Exclusive Call Hold mode></p> <ul style="list-style-type: none"> • Flashing green moderately: Your held call

Button	Description & Programming Input
<p>Direct Station Selection (DSS)</p>	<p>Used to access an extension with one touch. It is also possible to be changed to the other feature button.</p> <p>Programming Input 1 + Extension no.</p> <p>For intercom calls, the DSS button light shows the current status as follows:</p> <ul style="list-style-type: none"> • Off: The extension is idle. • Red on: Your or another extension is using the line.
<p>One-touch Dialing²</p>	<p>Used to access a desired party or system feature with one touch.</p> <p>Programming Input 2 + Desired no. (max. 32 digits)</p>
<p>Incoming Call Distribution Group (ICD Group)</p>	<p>Used to access a specified incoming call distribution group for making or receiving calls.</p> <p>Programming Input 3 0 + Incoming call distribution group extension no. (+ # + delayed ringing time [0–7])³</p> <p>For monitoring and changing the Log-in/Log-out status of extensions, the DSS button light shows the current status as follows:</p> <ul style="list-style-type: none"> • Off: The extension is not in the group. • Green on: Log-in (Ready) mode • Flashing green: Log-in (Not Ready) mode • Red on: Log-out mode
<p>Message</p>	<p>Used to leave a message waiting indication or call back the party who left the message waiting indication.</p> <p>Programming Input 4 0</p> <p>The message button light shows the current status as follows:</p> <ul style="list-style-type: none"> • Off: You have no new messages. • Red on: You have new messages.
<p>Message for Another Extension</p>	<p>Used to have a Message button for another extension.</p> <p>Programming Input 4 0 + Extension no./Incoming call distribution group extension no.</p> <p>The message button light shows the current status as follows:</p> <ul style="list-style-type: none"> • Off: The other extension has no messages. • Red on: The other extension has new messages.

Button	Description & Programming Input
Call Forwarding (FWD)/Do Not Disturb (DND)—Both calls	<p>Used to forward all calls to a specified destination or refuse.</p> <p>Programming Input 4 1</p>
FWD/DND—Outside calls	<p>Used to forward outside calls to a specified destination or refuse.</p> <p>Programming Input 4 2</p> <p>The FWD/DND button light shows the current status as follows:</p> <ul style="list-style-type: none"> • Off: Both features are not set. • Red on: FWD mode • Flashing red slowly: DND mode
FWD/DND—Intercom calls	<p>Used to forward intercom calls to a specified destination or refuse.</p> <p>Programming Input 4 3</p> <p>The FWD/DND button light shows the current status as follows:</p> <ul style="list-style-type: none"> • Off: Both features are not set. • Red on: FWD mode • Flashing red slowly: DND mode
Group FWD—Both calls	<p>Used to forward all the calls to your group to a specified destination.</p> <p>Programming Input 4 4 + Incoming call distribution group extension no.</p> <p>The Group FWD button light shows the current status as follows:</p> <ul style="list-style-type: none"> • Off: No set • Red on: FWD mode
Group FWD—Outside calls	<p>Used to forward the outside calls to your group to a specified destination.</p> <p>Programming Input 4 5 + Incoming call distribution group extension no.</p> <p>The Group FWD button light shows the current status as follows:</p> <ul style="list-style-type: none"> • Off: No set • Red on: FWD mode

Button	Description & Programming Input
Group FWD—Intercom calls	<p>Used to forward the intercom calls to your group to a specified destination.</p> <p>Programming Input 4 6 + Incoming call distribution group extension no.</p> <p>The Group FWD button light shows the current status as follows:</p> <ul style="list-style-type: none"> • Off: No set • Red on: FWD mode
Account	<p>Used to enter an account code.</p> <p>Programming Input 4 8</p>
Conference	<p>Used to establish a multiple party conversation.</p> <p>Programming Input 4 9</p>
Terminate	<p>Used to disconnect the current call and make another call without hanging up.</p> <p>Programming Input 5 0</p>
External Feature Access (EFA)	<p>Used to access special features offered by a host PBX or a telephone company.</p> <p>Programming Input 5 1</p>
Call Park	<p>Used to park or retrieve a call in a preset parking zone.</p> <p>Programming Input 5 3 + Parking zone no. (2 digits)</p>
Call Park (Automatic Park Zone)	<p>Used to park a call in an idle parking zone automatically.</p> <p>Programming Input 5 3 *</p>
Call Log	<p>Used to show the incoming call information.</p> <p>Programming Input 5 4</p> <p>The Call Log button light shows the current status as follows:</p> <ul style="list-style-type: none"> • Off: No incoming call. Or you have already viewed the call log. • Red on: You have missed calls to view.

Button	Description & Programming Input
Call Log for ICD Group	<p>Used to have a Call Log button for incoming call distribution group.</p> <p>Programming Input 5 4 + Incoming call distribution group extension no.</p>
Log-in/Log-out	<p>Used to switch between the log-in and log-out mode.</p> <p>Programming Input 5 5</p>
Log-in/Log-out of a specified group	<p>Used to have a Log-in/Log-out button for another incoming call distribution group.</p> <p>Programming Input 5 5 + Incoming call distribution group extension no.</p> <p>The Log-in/Log-out of a specified group button light shows the current status as follows:</p> <ul style="list-style-type: none"> • Off: Log-in mode • Red on: Log-out mode
Log-in/Log-out for all groups	<p>Used to have a Log-in/Log-out button for all groups.</p> <p>Programming Input 5 5 *</p>
Hurry-up	<p>Used to transfer the longest waiting call in the queue of an incoming call distribution group to the overflow destination.</p> <p>Programming Input 5 6 + Incoming call distribution group extension no.</p> <p>The Hurry-up button light shows the current status as follows:</p> <ul style="list-style-type: none"> • Off: No waiting call. • Red on: Some calls are waiting. • Flashing red: The number of calls exceeds the manual queue redirection level.
Wrap-up	<p>Used to switch the wrap-up status, Ready and Not Ready mode.</p> <p>Programming Input 5 7</p> <p>The Wrap-up button alternates the setting of Wrap-up mode, Not Ready mode or Ready mode.</p> <p>The Wrap-up button light shows the current status as follows:</p> <ul style="list-style-type: none"> • Off: Ready mode • Red on: Not Ready mode • Flashing red: Wrap-up mode

Button	Description & Programming Input
System Alarm	<p>Used to confirm a PBX error.</p> <p>Programming Input 5 8</p>
Time Service (Day/Night/ Lunch/Break)	<p>Used to switch the time service mode.</p> <p>Programming Input 5 9 + 0/1/2/3* (+ # + Tenant no.)</p> <p>The Time Service (Day/Night/Lunch/Break) button light shows the current status as follows:</p> <ul style="list-style-type: none"> • Off: Day mode • Green on: Lunch mode • Flashing green: Break mode • Red on: Night mode • Flashing red: Holiday mode
Answer	<p>Used to answer an incoming call.</p> <p>Programming Input 6 0</p>
Release	<p>Used to disconnect the line during or after a conversation or to complete a Call Transfer.</p> <p>Programming Input 6 1</p>
Toll Restriction	<p>Used to change the toll restriction level of other extension users temporarily.</p> <p>Programming Input 6 2 + Toll Restriction Level (1–7)</p>
Calling Line Identification Restriction (CLIR)	<p>Used to switch between the CLIP and CLIR services.</p> <p>Programming Input 6 4</p> <p>You can change the mode by pressing a preset CLIR button while on-hook.</p> <p>The CLIR button light shows the current status as follows:</p> <ul style="list-style-type: none"> • Off: shows your telephone number. • Red on: prevents your telephone number being displayed.

Button	Description & Programming Input
<p>Connected Line Identification Restriction (COLR)</p>	<p>Used to switch between the COLP and COLR services.</p> <p>Programming Input 6 5</p> <p>You can change the mode by pressing a preset COLR button while on-hook. The COLR button light shows the current status as follows:</p> <ul style="list-style-type: none"> • Off: shows your telephone number. • Red on: prevents your telephone number being displayed.
<p>Headset</p>	<p>Used to talk using the headset.</p> <p>Programming Input 6 7</p> <p>The Headset button light shows the current status as follows:</p> <ul style="list-style-type: none"> • Off: Headset mode off • Red on: Headset mode on
<p>Time Service Switching Mode (Automatic/Manual)</p>	<p>Used to switch the time service mode, Automatic or Manual.</p> <p>Programming Input 6 8 (+ Tenant no.)</p> <p>The Time Service Switching Mode (Automatic/Manual) button light shows the current status as follows:</p> <ul style="list-style-type: none"> • Off: Automatic • Red on: Manual
<p>Network Direct Station Selection (NDSS)⁵</p>	<p>Used to access an extension connected to other PBXs in the network with one touch.</p> <p>Programming Input 6 9 + Another PBX extension no.</p> <p>The NDSS button light will show the current status as follows:</p> <ul style="list-style-type: none"> • Off: The extension is idle. • Red on: The extension is busy.
<p>CTI</p>	<p>Used to access CTI features.</p> <p>Programming Input 7 0</p>

Button	Description & Programming Input
Primary Directory Number (PDN)	<p>Used to make and receive both outside and intercom calls.</p> <p>Programming Input 7 1</p> <p>The PDN button light shows the current status as follows:</p> <ul style="list-style-type: none"> • Off: The PDN extension is idle. • Green on: The extension is on a call using the PDN button. • Flashing green slowly: A call is on hold at the PDN extension (Regular Hold). • Flashing green moderately: A call is on hold temporarily or on Exclusive Call Hold. • Flashing green rapidly: The PDN extension is receiving an incoming call. • Red on: A corresponding SDN extension is using the line. • Flashing red slowly: A corresponding SDN extension is holding a call.
Secondary Directory Number (SDN)	<p>Used to show the current status of another extension, call the extension, and pick up or transfer calls to it.</p> <p>Programming Input 7 2 + Extension no. + # + delayed ringing time (0–7)⁶</p> <p>The SDN button light shows the current status as follows:</p> <ul style="list-style-type: none"> • Off: The PDN extension is idle. • Green on: The extension is on a call using an SDN button. • Flashing green slowly: A call answered with the SDN button is on hold (Regular Hold). • Flashing green moderately: A call answered with the SDN button is on hold temporarily or on Exclusive Call Hold. • Flashing green rapidly: An SDN extension is receiving a Hold Recall or callback ringing from a call answered with the SDN button. • Red on: The corresponding PDN extension or another corresponding SDN extension is using the line. • Flashing red slowly: Another corresponding SDN extension, or the PDN extension itself, is holding a call.
Two-way Record ⁷	<p>Used to record a conversation into your own mailbox.</p> <p>Programming Input 9 0 + Voice mail floating extension no.⁸</p> <p>The Two-way Record button light shows the current status as follows:</p> <ul style="list-style-type: none"> • Off: Not recording. • On: Recording the conversation.

Button	Description & Programming Input
Two-way Transfer ^{*7}	<p>Used to record a conversation into the mailbox of a specific extension.</p> <p>Programming Input 9 1 + Voice mail floating extension no.^{*8}</p> <p>The Two-way Transfer button light shows the current status as follows:</p> <ul style="list-style-type: none"> • Off: Not recording. • On: Recording the conversation.
One-touch Two-way Transfer ^{*7}	<p>Used to record a conversation into the mailbox of a specific extension with one touch.</p> <p>Programming Input 9 1 + Voice mail floating extension no.^{*8} + # + Extension no./ Incoming call distribution group extension no.</p> <p>The One-touch Two-way Transfer button light shows the current status as follows:</p> <ul style="list-style-type: none"> • Off: Not recording. • On: Recording the conversation.
Live Call Screening (LCS) ^{*7}	<p>Used to monitor your own voice mailbox while an incoming caller is leaving a message and, if desired, intercept the call.</p> <p>Programming Input 9 2</p> <p>The Live Call Screening (LCS) button light shows the feature status as follows:</p> <ul style="list-style-type: none"> • Off: LCS is off. • Flashing green rapidly: Alerting in the Private mode. • Flashing green slowly: Monitoring. • Red on: LCS is on.
Voice Mail Transfer ^{*7}	<p>Used to transfer a call to the mailbox of a specified extension.</p> <p>Programming Input 9 4 + Voice mail floating extension no.^{*8}</p>

^{*1} The flexible buttons work as Single-CO (S-CO) button by default.

^{*2} "*", "#", FLASH/RECALL, PAUSE, Secret (INTERCOM) and TRANSFER can also be stored.

If you do not want to display the stored number when making a call, press the Secret (INTERCOM) button before and after the numbers you wish to conceal.

If you need to enter an account code, you can enter the specified account code before the line access number.

<Example>

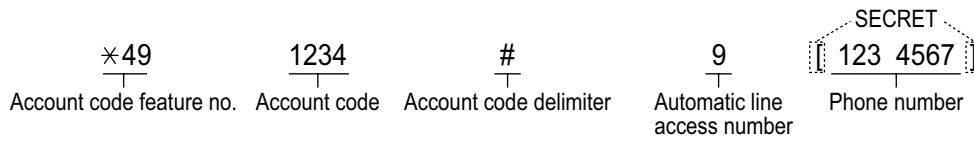

- ³ Depending on the settings of your PBX, you may be required to enter delayed ringing time (0: Immediate, 1: 1 ring, 2: 2 rings, 3: 3 rings, 4: 4 rings, 5: 5 rings, 6: 6 rings, 7: No ring). In this case, you can automatically join a new ICD Group by creating a button for that group.
- ⁴ 0: Day/Night/Lunch/Break, 1: Day/Night/Break, 2: Day/Night Lunch, 3: Day/Night
- ⁵ The button may not be available depending on the networking method in use or the settings of the PBX.
- ⁶ It is possible to set delayed ringing for each SDN button.
- ⁷ This button is used for the integrated voice mail features.
- ⁸ The default voice mail floating extension number is 500.

Clearing Flexible Buttons

You can clear the number or feature assigned to a flexible button.

1. Press the **Options** tab > **Administrator Options** > **Programming**.
2. On the **Programming** screen, press **PROG**.



3. Select the page number of the flexible button you want to clear.

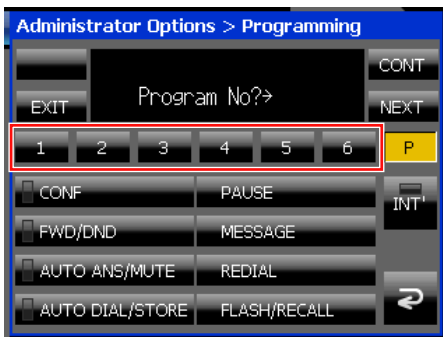

- Select the flexible button you want to clear.

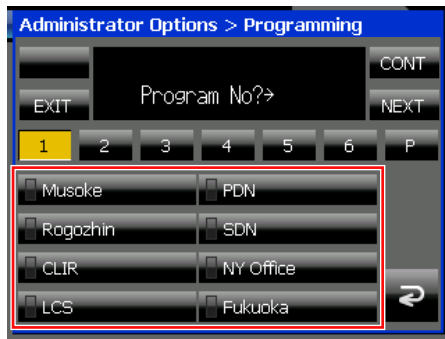

- Press **2**.
- Press **ENTER** (ENTER) 2 times.
- To continue clearing buttons, repeat the procedure from step 3.
To exit, press **EXIT**.

!! Usage tips

- You can also clear the number or feature assigned to a flexible button on the **Calls** screen or the **Feature Key** screen (in Call List mode). For details, see "Calls Screen in Line Buttons Mode (Page 37)" and "Feature Key Screen (Page 55)".

Entering Characters

The dial keys are used to enter characters and numbers. Each of the dial keys has multiple characters assigned to it. To enter a character, press the appropriate dial key until the character you want appears. To enter another character that is assigned to the same key, first press **▷ (RIGHT)** to move the cursor to the right.

Character Tables

You can enter alphabetic characters and digits using the dial keys. Pressing a dial key repeatedly displays different characters, as shown in the following tables.

While entering characters, you can move the cursor with **◀ (LEFT)** and **▶ (RIGHT)** on the Navigator key. On the **Calls** screen, the **Feature Key** screen (in Call List mode), and the **Programming** screen, you can delete a character by pressing **⊙ (TRANSFER)**. On the other screens, you can delete a character by pressing **◀ (LEFT)** on the Navigator key. For a list of available characters, refer to the following pages. The tables show you the characters available for each button.

Note

- You can switch the character table by pressing **⋮:au**.

Table 1 (Standard mode)

Times Buttons	1	2	3	4	5	6	7	8	9
①	!	?	"	1					
②	A	B	C	a	b	c	2		
③	D	E	F	d	e	f	3		
④	G	H	I	g	h	i	4		
⑤	J	K	L	j	k	l	5		
⑥	M	N	O	m	n	o	6		
⑦	P	Q	R	S	p	q	r	s	7
⑧	T	U	V	t	u	v	8		
⑨	W	X	Y	Z	w	x	y	z	9
⑩	(space)	.	,	'	:	;	0		
* ⑪	/	+	-	=	<	>	*		
# ⑫	\$	%	&	@	()	€	£	#

Note

- A space counts as one character.

Table 2 (Option mode)

Times Buttons	1	2	3	4	5	6	7	8	9	10	11	12	13	14	15
①	!	?	"	ä	ö	ü	1								
②	A	B	C	a	b	c	À	Á	Â	Ã	Ä	Å	Æ	Ç	2
③	D	E	F	d	e	f	Ð	È	É	Ê	Ë	3			
④	G	H	I	g	h	i	Ì	Í	Î	Ï	4				
⑤	J	K	L	j	k	l	5								
⑥	M	N	O	m	n	o	Ñ	Ò	Ó	Ô	Õ	Ö	Ø	Œ	6
⑦	P	Q	R	S	p	q	r	s	Š	ß	7				
⑧	T	U	V	t	u	v	Û	Ú	Û	Ü	8				
⑨	W	X	Y	Z	w	x	y	z	Ý	Ž	9				
⑩	(space)	.	,	'	:	;	0								
* ⑪	/	+	-	=	<	>	*								
# ⑫	\$	%	&	@	()	€	£	#						

Note

- A space counts as one character.

Installation and Settings

Connections

This section explains the ports and connectors on the KX-NT400.

Connections for Ethernet/PC/AC Adaptor

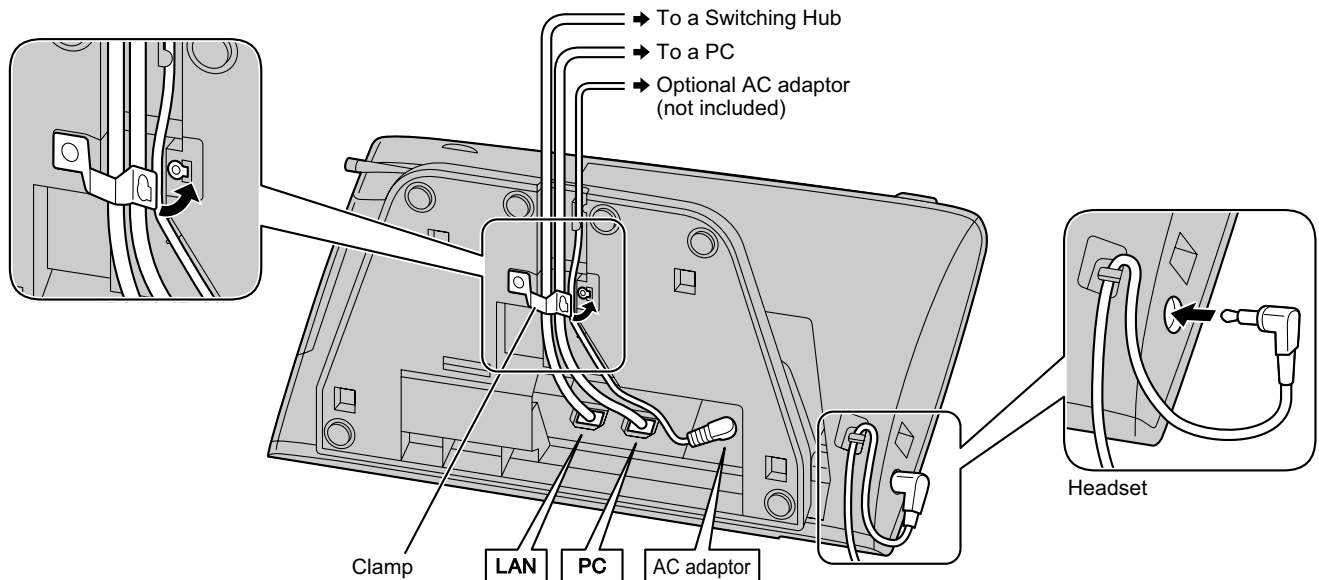

CAUTION

AC adaptor (Optional)

- Use a Panasonic AC adaptor KX-A420 (PSLP1662).
- When the optional AC adaptor is used, that is the main disconnect device to stop electricity supply. Ensure that the AC outlet is located near the unit and is easily accessible.

When connecting a headset

- Ensure that the headset cord has slack and is not pulled tight during use to prevent damage to the connectors.

Notice

It is recommended that you use one of the following Panasonic headsets:

- KX-TCA86
- KX-TCA92

When selecting Ethernet cables

- Use flexible, high-quality, snagless (without strain relief) cables. Do not use cables with coating that may tear or crack when bent.
To prevent damage to the cables, use cables that do not protrude from the bottom of the base.

Connect the cables as shown in the following illustration.

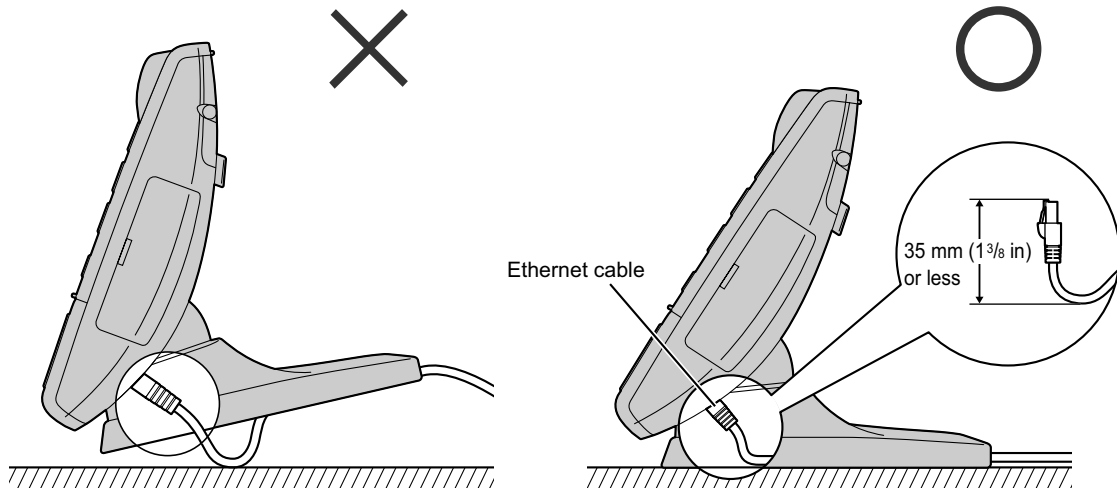

- Use a straight CAT 5 (or higher) Ethernet cable (not included) that is 6.5 mm (1/4 in) in diameter or less.
- For further information on the connection to a PC, see the documentation for the PBX.

When connecting cables

- Ensure that the Ethernet cables and the AC adaptor cord are clamped to prevent damage to the connectors.

Connections for Handset

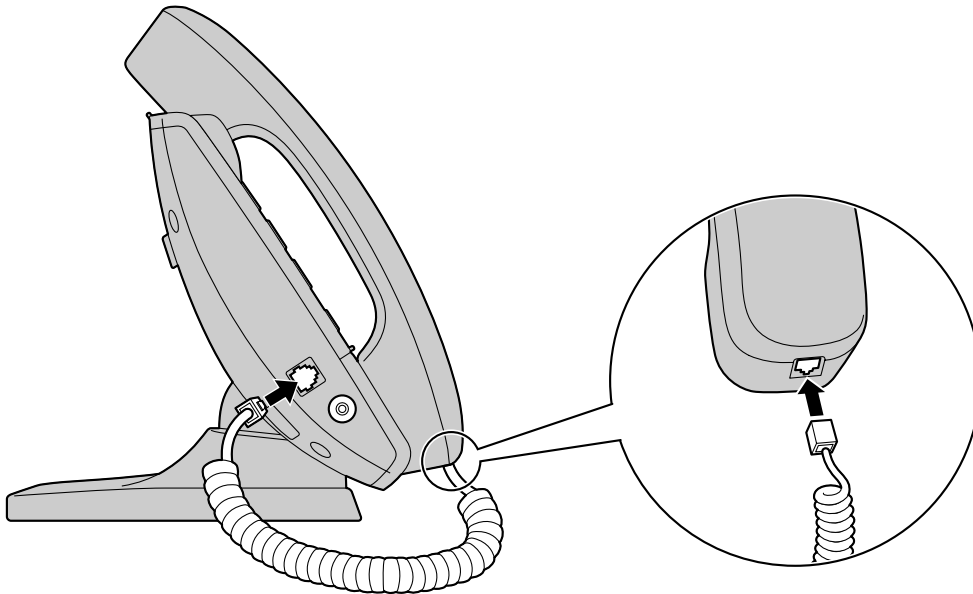

Connections for a USB Device

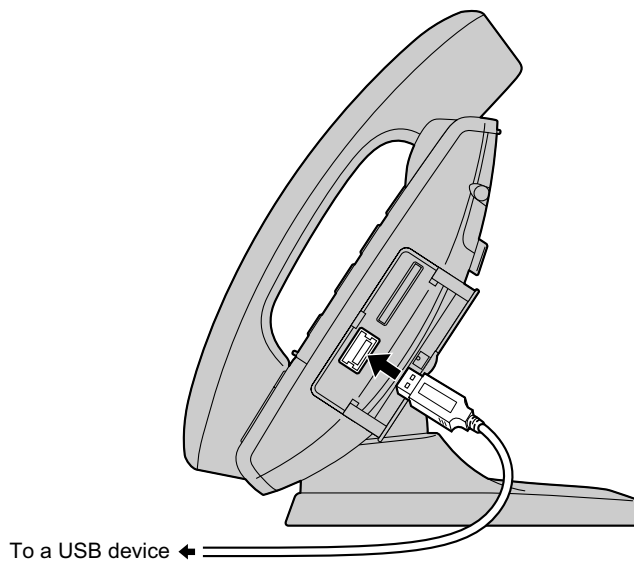

CAUTION

When connecting a USB device

- Ensure that the USB cable has slack and is not pulled tight during use to prevent damage to the connectors.

Wall Mounting

Before Mounting on a Wall

To mount the KX-NT400, it is necessary to set the angle of the base flat.

CAUTION

Place a soft cloth under the KX-NT400 when you put its face down to protect the LCD and to prevent the KX-NT400 from getting scratched.

Notice

- The angle of the base is set to flat when the product is shipped.

1. Set the operation board angle to its lowest level.
See "To lower: (Page 24)".
2. As shown in the following illustration, put the KX-NT400 face down, hold up the tab to disengage the lock (①), hold down the angle adjustment button (②), and then push the base down until the angle of the base is flat (③).

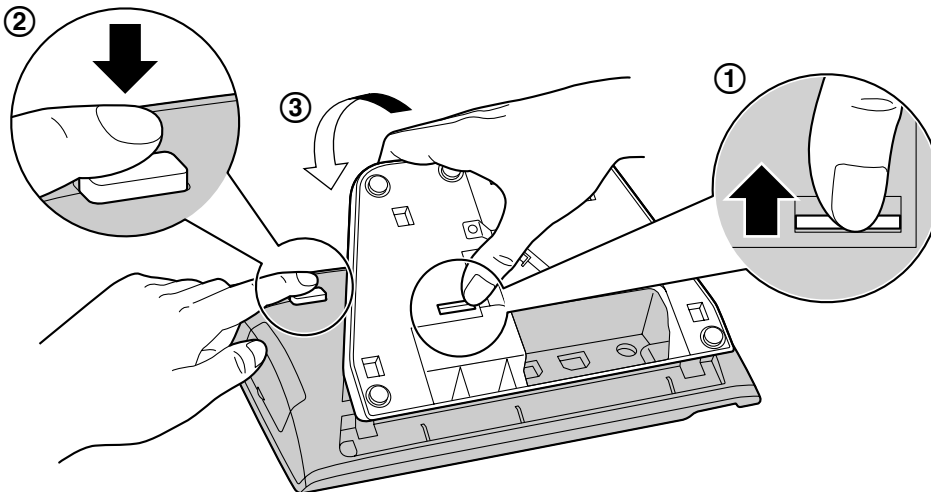

Mounting the KX-NT400

WARNING

- Make sure that the wall that the unit will be attached to is strong enough to support the unit (approx. 1.25 kg [2.76 lb]).
If not, it is necessary for the wall to be reinforced.
- Only use the wall mounting equipment (screws, washers, wall mounting adaptor) included with the KX-NT400.
- When driving the screws into the wall, be careful to avoid touching any metal laths, wire laths or metal plates in the wall.
- When this product is no longer in use, make sure to detach it from the wall.

CAUTION

- Make sure the cables are securely fastened to the wall.

1. Insert the 4 tabs of the wall mounting adaptor into the designated openings in the base, and then slide the wall mounting adaptor in the direction of the arrow until it clicks.

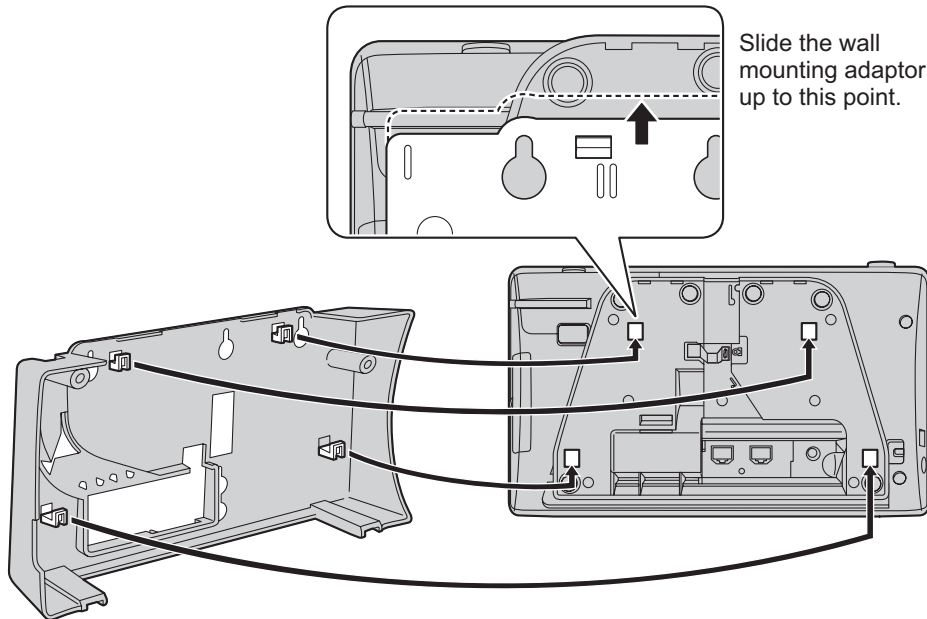

2. Fasten the wall mounting adaptor to the base with 2 screws (included).

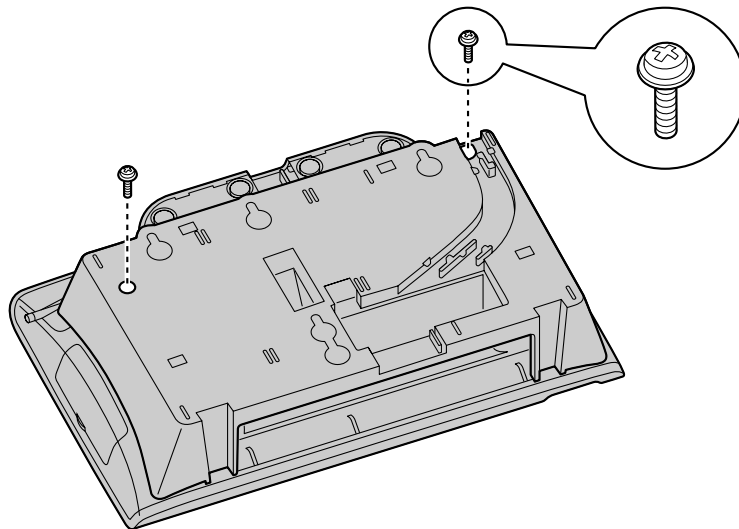

3. Connect the cables to the KX-NT400, and run the cables through the wall mounting adaptor, as shown in the illustration below.
For details about connecting the cables, see "Connections (Page 147)".

Note

- The cables can also be run from the bottom of the unit.

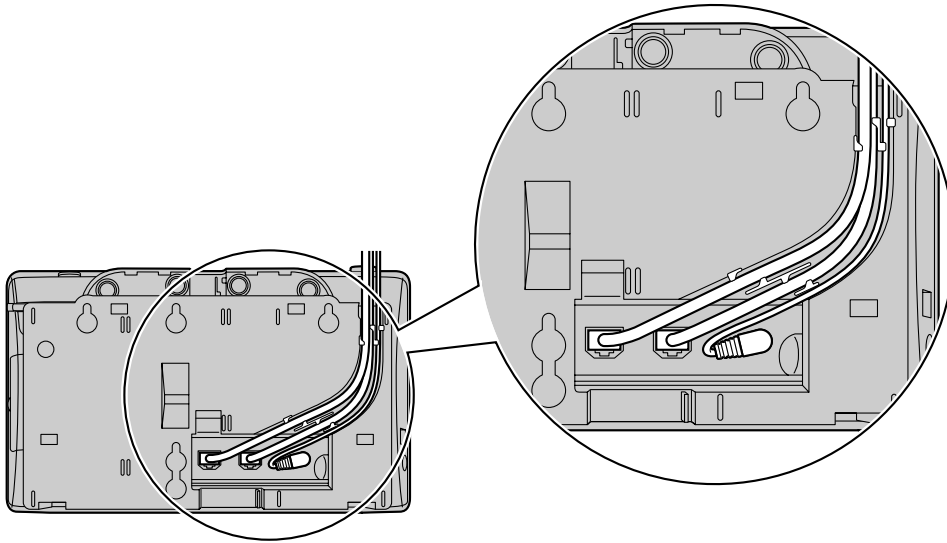

4. Drive 3 screws (included) into the wall as shown in the illustration below, and mount the KX-NT400 on the wall.

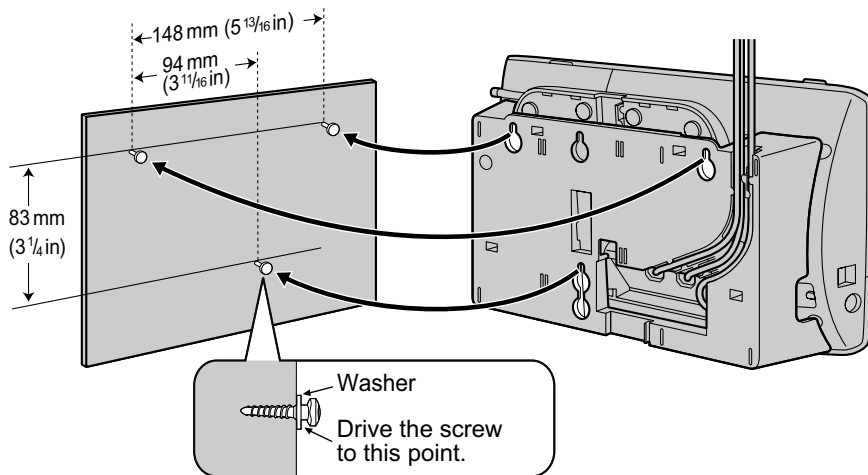

!! Usage Tips

- You can find a wall mounting template at the end of this manual.
- For information about locking the handset, see "Hooking the Handset (Page 25)".

Bluetooth Headset Connections

Installation

CAUTION

Before touching the KX-NT307 Bluetooth module, discharge static electricity by touching ground. Otherwise, this module may malfunction due to the static electricity.

Installing the KX-NT307 Bluetooth Module

1. Disconnect the Ethernet cable (and AC adaptor if used) and make sure that the power is off.
2. Remove the screw as shown in the illustration below.

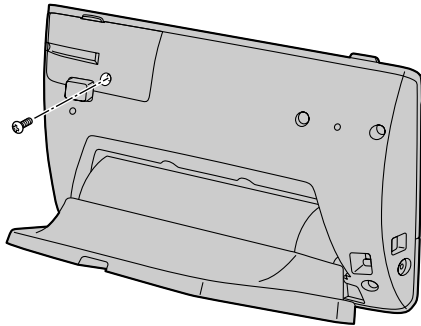

3. Remove the cover as shown in the illustration below.

Notice

- To prevent the KX-NT400 from getting scratched, do not use hard, sharp tools (flat drivers, craft knives, etc.) to open the cover.

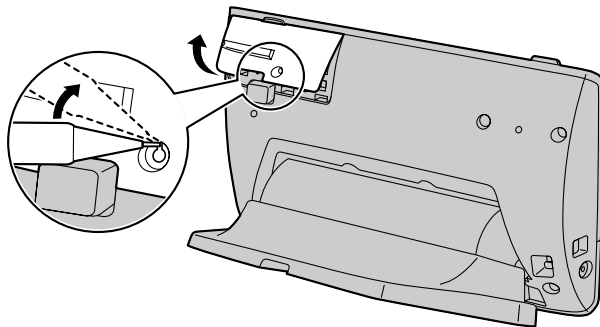

4. Install the KX-NT307 Bluetooth module to the Bluetooth module socket (see "Location of Controls (Page 18)").

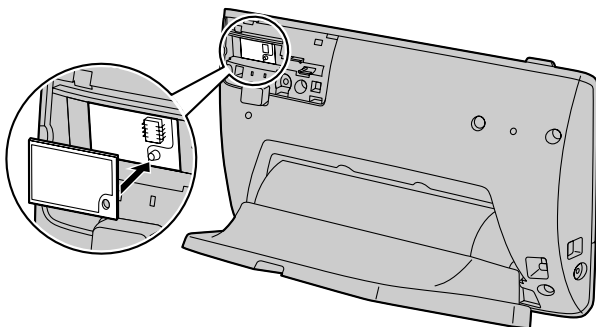

5. Re-attach the cover.

6. Connect the Ethernet cable (and the AC adaptor if necessary) to the KX-NT400.

Bluetooth Headset Operation

The KX-NT307 Bluetooth module allows third party Bluetooth headsets to be used with the KX-NT400. It is not guaranteed that all features of the Bluetooth headset will be available when used with the KX-NT307 Bluetooth module.

Note

- One Bluetooth headset can be registered with the module.
- The KX-NT307 Bluetooth module supports Bluetooth devices that use the headset profile (HSP) and hands-free profile (HFP).

Registering the Bluetooth headset

Set the headset pairing mode by following the instructions provided with the Bluetooth headset.

1. Press the **Options** tab > **Administrator Options** > **Programming**.
2. On the **Programming** screen, press **PROG**.



3. Press **6 6**.
4. Press **ENTER** (**ENTER**).
5. Enter the Pass Key for your Bluetooth headset and then press **ENTER** (**ENTER**).

For more information regarding the Pass Key, see the documentation for your headset, or consult the Bluetooth headset's manufacturer.

- When registration has been completed, you will hear a confirmation tone.
 - If you hear a warning tone, confirm the Bluetooth headset's Pass Key, press **CANCEL** (**CANCEL**), and repeat this step.
6. Press **EXIT** to exit programming mode.

Note

- If you have already registered a Bluetooth headset that you do not want to use anymore, register the correct headset.

- For more information about confirmation and warning tones, refer to the Operating Manual of the PBX.

Assigning a Headset Mode button

A flexible key can be assigned as a Headset Mode button.

The Headset Mode button can be used to turn Headset Mode on and off. A flexible button assigned as the Headset Mode button displays Headset Mode status as follows:

- **Red:** Headset Mode on
- **Off:** Headset Mode off

1. Press the **Options** tab > **Administrator Options** > **Programming**.
2. On the **Programming** screen, press **PROG**.



3. Press the flexible button you want to assign.



4. Press **6 7**, and then press **ENTER** (**ENTER**).

Confirming the ID of the Bluetooth headset and de-registering the Bluetooth headset

1. Press the **Options** tab > **Administrator Options** > **Programming**.

- On the **Programming** screen, press **PROG**.



- Press **6** **7**.
- Press **ENTER** (**ENTER**).
 - Confirm that the displayed ID is the ID of your headset. For more information regarding the ID of your headset, see the documentation for your headset, or consult the Bluetooth headset's manufacturer.
 - If you do not want to perform de-registration, press **CANCEL** (**CANCEL**) 3 times.
- Press **ENTER** (**ENTER**) to de-register the headset.
- Press **EXIT** to exit programming mode.

Operating Distance

Please keep KX-NT400s with connected Bluetooth modules 3 m or more apart from each other. Also, if a Bluetooth headset is in use near a KX-NT300 series and KX-DT300 series telephone with a Bluetooth module, other than the one it is registered to, noise may be heard. To improve the signal, move away from the telephone and closer to the one it is registered to.

Noise

Signals are transmitted between this module and the Bluetooth headset using radio waves. For maximum distance and noise free operation, it is recommended that the module is situated away from electrical appliances such as faxes, radios, personal computers, or microwaves.

- Systems using the 2.4 GHz ISM (Industrial, Scientific and Medical) band may interfere with this product. Examples of such systems are cordless telephones, wireless LAN, Home RF, microwave ovens and other ISM devices. These systems may cause minor noise.

Notice

Operation is subject to the following two conditions:

- this device may not cause interference, and
- this device must accept any interference,

including interference that may cause undesired operation of the device. Privacy of communications may not be ensured when using this module.

Setting Up the KX-NT400

This section describes the settings that you can configure when you start the KX-NT400.

IMPORTANT

- The KX-NT400 requires 2 IP addresses for its operation. Before configuring the start-up settings, make sure that 2 IP addresses are available for the KX-NT400.
- Using the PC Maintenance Console to program the PBX, you must set the Incoming Call Log Memory for the KX-NT400 to 0. If you do not change this setting, missed calls will not be handled correctly on the **Calls** screen or the **Feature Key** screen (in Call List mode). For details about the Incoming Call Log Memory setting, see the PBX's documentation.
- The "ringing" icons on the **Contacts** screen (for example, ) do not appear if you use the default settings. To make the ringing icons appear, you must set the DSS key mode for Incoming Call setting to "ON or Flash" using the PC Maintenance Console. For details, see the PBX's documentation.

Accessing the Start-up Settings

1. Connect the KX-NT400 to an Ethernet cable capable of delivering power (PoE compliant), or use an optional AC adaptor to supply power.
2. Connect the KX-NT400 to the network.

Note

The first time you start the KX-NT400, the calibration screen appears. Follow the instructions to calibrate the screen. For details, see "Display Settings (Page 113)".

3. On the start-up screen, press **Setup**.

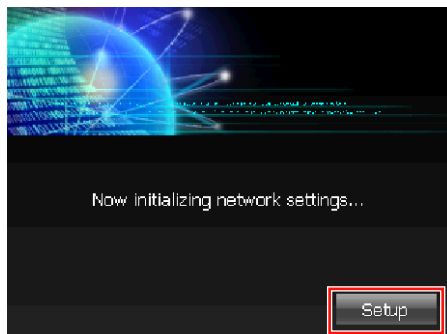

4. Select the item for the settings you want to configure.

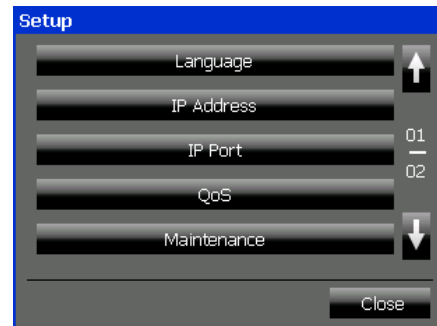

Start-up menu

From the menu on the **Setup** screen, you can access the following settings screens to configure the start-up settings:

- 1. Language** (→ Page 159)
If you prefer to use a language other than English, change your language settings first.
- 2. IP Address** (→ Page 159)
You must configure the IP address settings in order to connect to the network and use the KX-NT400.
- 3. IP Port** (→ Page 160)
If your network uses different ports than the default settings, change these settings to match those of your network. For a list of defaults, see "Network—IP Port (Page 176)".
- 4. QoS** (→ Page 161)
If your network uses QoS (Quality of Service) for voice communication, configure these settings to match those of your network.
- 5. Maintenance** (→ Page 162)
View the MAC addresses for the KX-NT400's network adaptors, and test connections to other network devices.
- 6. Firmware Version Update** (→ Page 163)
If a new firmware version is released, perform a firmware upgrade to install the latest version. For details about firmware, consult your dealer.
- 7. Initialize Settings** (→ Page 165)
Initializing the settings resets the KX-NT400 to its factory shipment state. Performing this operation erases *all* data (contact lists, camera settings, etc.).
- 8. Firmware Version** (→ Page 165)
View the installed version of various firmware components.
- 9. Error Log** (→ Page 166)
View system error messages.

Exiting the start-up settings

- Press **Close** on the **Setup** screen.

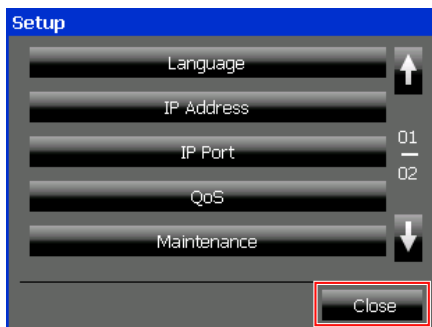

Note

- When you change certain settings, the KX-NT400 restarts automatically after you press **Close** on the **Setup** screen. For details, see "Restarting the KX-NT400 (Page 168)".

Language Settings

The Language settings allow you to select the display language.

You can select from a list of built-in languages, or, if you have an SD memory card with additional language files, you can select one of those languages.

Language Setting screen

Select the display language.



Language

Select **Language** and then press the drop-down list to select the display language from a list of built-in languages.

- Default: **English-US**
- Built-in languages: English-US, English-UK, French, French-CA, German, Spanish, Italian, Portuguese, Russian, Ukrainian

Another

Select **Another** and then press  to select the display language from an SD memory card. Language files must be stored in the following directory on the SD memory card:
`\private\meigroup\pcc\pbxpt\nt400`

Notice

- If you have modified any of the preset presence settings, changing the language resets them to their default settings.

Note

- This language setting is not effective for the sub-display on the **Calls** screen, the **Feature Key** screen (in Call List mode), and the **Programming** screen. To change the language settings for the sub-display, see "PT Programming (Page 125)".
- For details about obtaining additional language files, consult your dealer.

IP Address Settings

To properly connect the KX-NT400 to a network, the IP address settings must be configured to match the settings of the network. Consult your administrator for details about the correct settings.

Note

- The KX-NT400 requires 2 IP addresses. Confirm that the 2 IP addresses are prepared for it before configuring the IP Address settings.

IP Address Setting screen (1/2)

Enter the IP addresses that the KX-NT400 will use to communicate over the network. If you use a DHCP server, these addresses will be automatically obtained from the DHCP server.

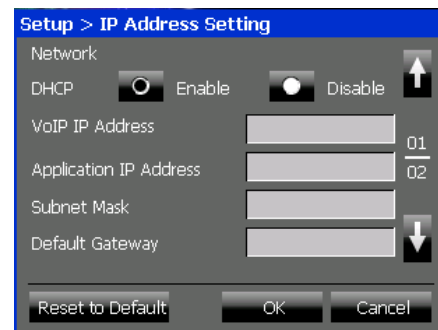

DHCP

Select whether to use a DHCP server to obtain the IP addresses for the KX-NT400.

If you select **Disable**, you must enter the following IP address settings manually.

- Default: **Enable**

VoIP IP Address

Enter the IP address for sending and receiving VoIP data.

Application IP Address

Enter the IP address for sending and receiving other IP data.

Subnet Mask

Enter the subnet mask for the network segment that the KX-NT400 is connected to.

Default Gateway

Enter the IP address of the default gateway.

IP Address Setting screen (2/2)

Enter the IP address of the PBX or PBXs that the KX-NT400 will communicate with.

Note

The IP addresses of PBXs cannot be obtained from the DHCP server. You must manually enter the PBX IP addresses.

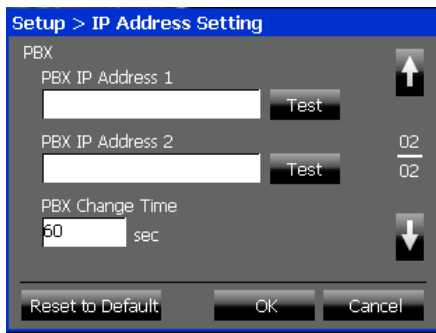

PBX IP Address 1

Enter the IP address of the primary PBX. Press **Test** to verify the connection to the PBX.

PBX IP Address 2

If your network uses a secondary PBX, enter the IP address of the secondary PBX. Press **Test** to verify the connection to the PBX.

PBX Change Time

If your network uses a secondary PBX, enter the length of the time before the failover process starts.

- Default: 60 seconds

Note

- You can confirm the connection to the secondary PBX after programming. When the KX-NT400 is starting up, press and hold both **(HOLD)** and **2** until the message "Now starting ..." appears. To reconnect to the primary PBX, restart the KX-NT400. For details, see "Restarting the KX-NT400 (Page 168)".
- You can also use the dial keys to enter the IP addresses. See "Entering Characters (Page 145)".
- You can reset the settings to their default values by pressing **Reset to Default**.

IP Port Settings

To properly connect the KX-NT400 to a network, the IP port settings must be configured to match the settings of the network. Consult your administrator for details about the correct settings.

If your network uses a secondary PBX, also fill in the following for **IP Port 2**:

- **PTAP Server**
- **PTAP Client**

Note

- These settings should be configured only by an administrator or installation personnel. An access code is required to access these screens.

IP Port Setting screen (1/2)

Enter the IP ports of the PTAP server and PTAP client for **IP Port 1** that the KX-NT400 will use to communicate over the network.

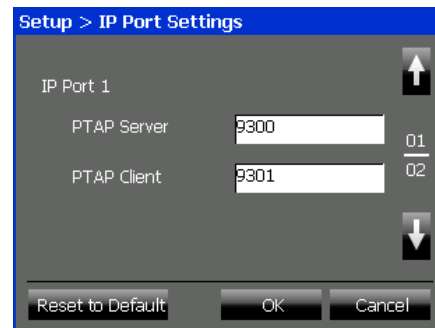

PTAP Server

Enter the port number for the PTAP server.

- Default: 9300

PTAP Client

Enter the port number for the KX-NT400 to use for PTAP communication.

- Default: 9301

IP Port Setting screen (2/2)

If your network uses a secondary PBX, enter the IP ports of the PTAP server and PTAP client for **IP Port**

2 that the KX-NT400 will use to communicate over the network.

PTAP Server

Enter the port number for the PTAP server.

- Default: 9300

PTAP Client

Enter the port number for the KX-NT400 to use for PTAP communication.

- Default: 9301

Note

- You can reset the settings to their default values by pressing **Reset to Default**.
- Consult your administrator for more details.

Quality of Service (QoS) Settings

To establish voice communications between the telephones, the primary port of the KX-NT400 and the connected PBX must belong to the same VLAN. Consult your administrator for details about the correct values.

QoS Setting screen (1/2)

Select whether to enable communication over a VLAN in the network. If you enable VLAN communication, enter the VLAN IDs and VLAN priorities for **Primary Port** and **Secondary Port**.

VLAN

Select whether to use VLAN to enhance the network traffic controlling.

- Default: **Disable**

Primary Port

VLAN ID

Enter the VLAN ID number to which the PBX belongs.

- Default: 1

VLAN Priority

Enter the priority for the VLAN.

- Default: 7

Secondary Port

VLAN ID

Enter the VLAN ID number to which the PBX belongs.

- Default: 2

VLAN Priority

Enter the priority for the VLAN.

- Default: 0

Note

- The KX-NT400 is equipped with 2 IP ports. Therefore it is possible to place the primary and

secondary ports of the KX-NT400 on different VLANs by assigning separate VLAN IDs to each port.

QoS Setting screen (2/2)

Select whether to enable communication via Diffserv. If you enable Diffserv communication, set **DS Field** for the **Primary Port**.

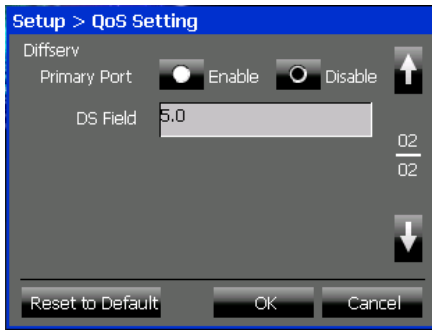

Primary Port

Select whether to use Diffserv to enhance the network traffic controlling.

- Default: **Disable**

DS Field

Enter the priority level of the KX-NT400's packets for the priority control.

- Default: 5.0

Note

- To use Diffserv, confirm that the routers installed to your network support this feature. For details, consult your administrator.
- You can reset the settings to their default values by pressing **Reset to Default**.

Maintenance

You can view MAC addresses of the KX-NT400 and verify connections for the network devices on this screen.

Network Maintenance screen

You can view the MAC addresses of the KX-NT400 and verify the network connection.

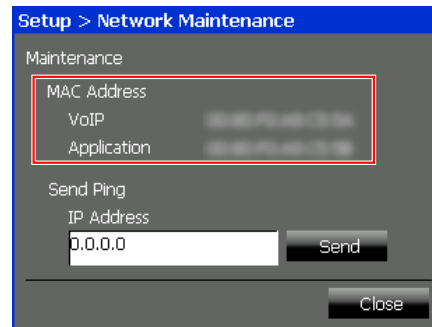

VoIP

Shows the MAC address used for VoIP data.

Application

Shows the MAC address used for data other than VoIP data.

Verifying a Connection (Send PING)

1. On the **Setup** screen, press **Maintenance**.
2. Enter an IP address in **IP Address**, and then press **Send**.
A window appears showing the result of the verification.
3. On the result window, press **Close**.

Firmware Version Update

You can upgrade the KX-NT400 firmware from an FTP server or an SD memory card.

You can also use the PC Maintenance Console to upgrade the firmware from an FTP server. For details, see the documentation for the PC Maintenance Console.

Note

- During the upgrade process, do not disconnect the power from the KX-NT400 or perform other operations, such as accessing other screens.
- This operation should be performed only by an administrator or installation personnel. An access code is required to access these screens.
- If a valid IP address has not been assigned to the KX-NT400, an error message will appear when you press **Firmware Version Update**. Make sure a valid IP address has been set. See "IP Address Settings (Page 159)".
- The **Firmware Version Update** button is disabled if the IP Address settings have been changed without restarting the KX-NT400. For details about restarting, see "Restarting the KX-NT400 (Page 168)".
- If you experience problems when upgrading the firmware from an FTP server, see "Troubleshooting (Page 183)".

Firmware Version Update screen (1/4)

Enter the information for the FTP server to use for downloading the firmware.

FTP Server Address (required)

Enter the IP address of the FTP server.

FTP Server Control Port (required)

Enter the port number that the FTP server uses for control communications.

- Default: 21

Firmware Version Update screen (2/4)

Enter the information for the FTP server to use for downloading the firmware.

FTP User ID (required)

Enter the User ID for the FTP server.

FTP User Password (required)

Enter the password for the FTP server.

FTP Path (required)

Enter the full path for the firmware file stored in the FTP server.

- Default: C:/panasonic/nt400

FTP File Name (required)

Enter the file name of the firmware file stored in the FTP server.

- Default: PNT400

Firmware Version Update screen (3/4)

Enter information for the network that the FTP server for upgrading the KX-NT400 firmware belongs to. If a VLAN is used on the network, enter the VLAN ID and VLAN priority.

VLAN

Select whether a VLAN is used on the network.

- Default: **Disable**

VLAN ID

Enter the ID for the VLAN.

- Default: 1

VLAN Priority

Enter the priority for the VLAN.

- Default: 7

Upgrading the Firmware via FTP

1. On the **Setup** screen, press **Firmware Version Update**.
2. Configure the FTP server settings.
3. Press **Start** next to **Download** to begin downloading.
The KX-NT400 starts downloading the firmware file, and a window appears indicating the status of the download.
4. On the **Firmware Version Update** screen, press **Start** next to **Ver Update** to begin the upgrade.
The upgrade will start, and a window appears indicating the status of the upgrade.
5. When the upgrade finishes, the KX-NT400 reboots automatically.

Firmware Version Update screen (4/4)

Enter the full path and file name for the firmware file stored in an SD memory card.

The firmware data must be stored in the following directory on the SD memory card:

`\private\meigroup\pcc\pbxpt\nt400`



File Name

Enter the full path of the firmware.

—or—

Press  to browse the SD memory card to find the file.

Upgrading the Firmware from an SD Memory Card

1. Insert an SD memory card that contains the firmware file.
2. On the **Setup** screen, press **Firmware Version Update**.

3. In **File Name**, enter the full path to the firmware file.
4. Press **Start**.
The upgrade will start, and a window appears indicating the status of the upgrade.
5. When the upgrade finishes, the KX-NT400 reboots automatically.

Note

- You can reset the settings to their default values by pressing **Reset to Default**.

Setting Initialize

Initializing the settings returns all settings to their default values.

Note

- The password for the Application Lock will not be initialized.
- This operation should be performed only by an administrator or installation personnel. An access code is required to access this screen.

Initialize Settings screen

Reset all settings to their default values.

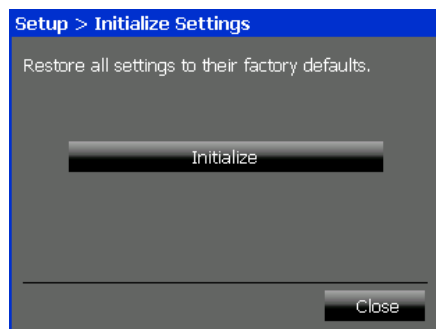

Initializing the settings

1. On the **Setup** screen, press **Initialize Settings**.
2. On the **Initialize Settings** screen, press **Initialize**.
3. On the confirmation dialog, press **OK**.
The initialization process starts.
4. When the initialization process finishes, the KX-NT400 reboots automatically.

Firmware Version

You can view the firmware version of the KX-NT400 on this screen.

Firmware Version screen



VoIP IPL Version

Shows the firmware version of the VoIP IPL.

VoIP Application Version

Shows the firmware version of the VoIP Application.

Application Loader Version

Shows the firmware version of the Application loader.

Application Version

Shows the firmware version of the Application.

Error Log

You can view the system error messages of the KX-NT400 on this screen. For details about error message meanings, see "Error Codes (Page 193)".

Error Log screen

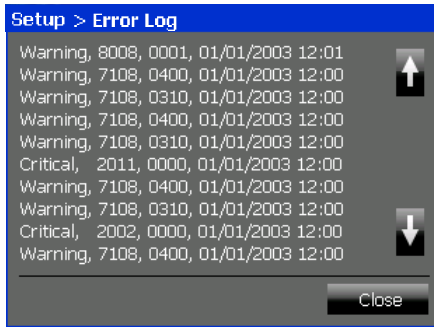

Maintaining the KX-NT400

Data Maintenance

You can delete the call logs, contact lists, and chat log from the KX-NT400.

You can also back up system settings, logs, and your personal contacts to an SD memory card as a CSV file. This CSV file is editable with general text editors. The CSV file can also be imported to other KX-NT400s to copy the original settings and contact lists. You can select the desired files and settings by selecting the check boxes for each data.

To maintain the data:

1. Press the **Options** tab > **Administrator Options** > **Maintenance**.

Maintenance screen (1/4)



Local Directory - Delete All

Press **Delete** to delete all of your personal contacts from the local directory.

Call Log Delete

Press **Delete** to delete all the call logs.

Delete Chat Log

Press **Delete** to delete the chat log.

Format SD Card

Press **Format** to format the SD memory card.

Maintenance screen (2/4)

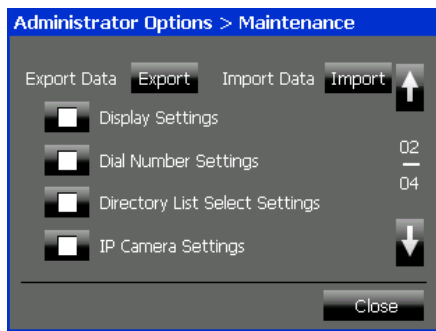

Export Data

Press **Export** to export the selected settings and data.

Import Data

Press **Import** to import the selected settings and data.

Display Settings

Select the check box to export/import the Display settings.

For details about Display settings, see "Display Settings (Page 113)".

Dial Number Settings

Select the check box to export/import the Dial number settings.

For details about Dial Number settings, see "Dial Number Settings (Page 114)".

Directory List Select Settings

Select the check box to export/import the Directory list select settings.

For details about Directory List Select settings, see "Directory List Select Settings (Page 115)".

IP Camera Settings

Select the check box to export/import the Network camera settings.

For details about IP Camera settings, see "IP Camera Settings (Page 116)".

Maintenance screen (3/4)

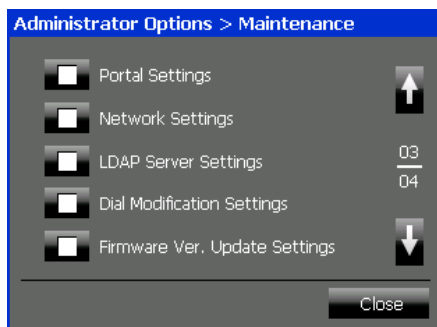

Portal Settings

Select the check box to export/import the portal settings.¹

For details about Portal settings, see "Portal Settings (Page 117)".

Network Settings

Select the check box to export/import the network settings.

For details about network settings, see "Setting Up the KX-NT400 (Page 157)".

LDAP Server Settings

Select the check box to export/import the LDAP server settings.

For details about LDAP Server settings, see "LDAP Server Settings (Page 121)".

Dial Modification Settings

Select the check box to export/import the Dial modification settings.

For details about Dial Modification settings, see "Dial Modification Settings (Page 122)".

Firmware Ver. Update Settings

Select the check box to export/import the firmware version update settings.

For details about Firmware Version Update settings, see "Firmware Version Update (Page 163)".

¹ If you import Portal settings, no homepage will be set, even if a homepage was set when the settings were exported.

Maintenance screen (4/4)

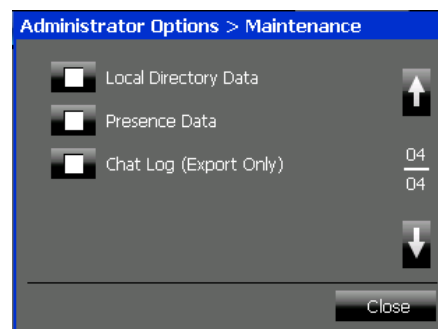

Local Directory Data

Select the check box to export/import the local directory data.

For details about the local directory settings, see "Contact List (Page 108)".

Presence Data

Select the check box to export/import the presence settings data.

For details about presence settings, see "Presence Settings (Page 118)".

Chat Log (Export Only)

Select the check box to export the chat log. For details about the chat log, see "Chat (Page 83)".

Note

SD Memory Card Information

Confirm the following before using an SD memory card.

- A compatible card is inserted (see "Compatible SD Memory Cards (Page 181)").
- The SD memory card has been formatted using the correct format (see "Formatting SD Memory Cards (Page 182)").
- The SD memory card is not locked (see "Write Protection (LOCK) (Page 181)").
- Data stored on SD memory cards can be corrupted if the card is exposed to electromagnetic fields, static electricity, etc. We recommend to back up important data stored on SD memory cards.
- The KX-NT400 cannot delete the contents of the SD memory card unless you format it. Use computers to individually delete the contents of an SD memory card.

Initializing the KX-NT400

You can initialize the KX-NT400 to reset all settings to their default values. This feature is only accessible from the **Setup** screen.

For details about initializing the KX-NT400, see "Setting Initialize (Page 165)".

Restarting the KX-NT400

Automatic Restarting

When you change certain settings, the KX-NT400 restarts automatically.

On the Setup screen

During the setup procedure, when you change settings on the following screens, the KX-NT400 automatically restarts after you press **Close** on the **Setup** screen.

- Language Settings (Page 159)
- IP Address Settings (Page 159)
- IP Port Settings (Page 160)
- Quality of Service (QoS) Settings (Page 161)
- Firmware Version Update (Page 163)
- Setting Initialize (Page 165)

Note

- For details about the **Setup** screen, see "Setting Up the KX-NT400 (Page 157)".

On the Options screen

During normal use, when you change settings on either of the following screens, the KX-NT400 restarts automatically after you press **OK** on the respective screen.

- Display Settings (Page 113)^{*1}
- Language Settings (Page 115)

^{*1} Restarting occurs only when **Display Color** is changed.

Manual Restarting (System Reset)

When the settings for the KX-NT400 have been changed via the PC Maintenance Console or changes have been made to the PBX's configuration, the KX-NT400 requires manual restarting.

To perform a manual restart, disconnect the Ethernet cable (when using PoE) or unplug the AC adaptor from the power outlet.

The KX-NT400 does not have a system reset button.

Some examples of when the KX-NT400 needs to be restarted are listed below:

- The Forward/Do Not Disturb settings have been changed via the PC Maintenance Console.
- The presence status settings have been changed via the PC Maintenance Console.
- The floating extension number of the simplified voice message system (SVM) or Panasonic Voice Processing System (VPS) has changed. In this case, make sure to set the new extension number

in Dial Number Settings after restarting. (See "Dial Number Settings (Page 114)").

- A portable station is configured to share an extension number with the KX-NT400.
- The configuration of the connected PBX has changed.
- The time setting of the connected PBX has changed.
- After you have exchanged the settings between extensions using the Walking Extension or Enhanced Walking Extension feature.

Note

- Connect the Ethernet cable properly when using PoE. The KX-NT400 will restart if a connection cannot be established due to an error.

Cleaning the KX-NT400

Clean the KX-NT400 periodically with a soft and dry cloth.

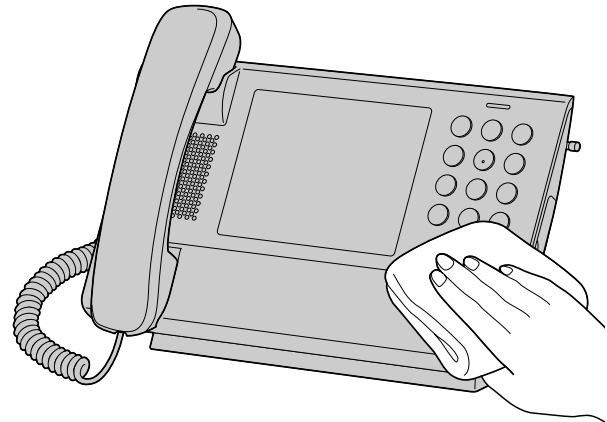

Keep the following in mind when cleaning the KX-NT400.

For the LCD

- Gently wipe the LCD with following only:
 - A soft and dry cloth.
 - A soft cloth with very small quantity of neutral detergent or ethyl alcohol.
- Do not press or rub the LCD touch screen with too much force during cleaning.

For the body

- To avoid damaging the KX-NT400, disconnect the Ethernet cable and all other cables from the KX-NT400 before cleaning. When using an AC adaptor, disconnect the AC adaptor from the KX-NT400 and power outlet before the cleaning.
- If the KX-NT400 becomes particularly dirty, apply a light kitchen cleanser to a soft cloth, wring the cloth thoroughly, and wipe the KX-NT400. When finished, dry the KX-NT400 with a soft and dry cloth.
- To avoid damage or discoloration, do not clean the KX-NT400 with the following materials, or with cleaners containing the following materials.
 - Petroleum
 - Scouring powder
 - Alcohol
 - Paint thinner
 - Benzene
 - Wax
 - Hot water
 - Powdered soap
- When using chemical cleansers, follow the instructions on the label carefully.

Appendix

Specifications

Item	Specification
Display	5.7 inch touch display QVGA (320 × 240 pixels) 65,535 colors
Feature Buttons	48
VoIP Connection Method	IP-PT
VoIP Audio Codec	G.722, G.711, G.729A
LAN Interface	IEEE 802.3 (10Base-T/100Base-TX)
IP Address Mode	Automatic (DHCP), Manual (static)
Speaker	1
Microphone	1
IP Network Interface Jack (LAN)	2 (RJ45)
USB Port	1 (USB1.1 USB low power device only)
SD Memory Card Slot	1 (32 MB–2 GB)
Audio Interface Jack	1 (ø 2.5 mm)
Dimensions	About 159 mm (H) × 277 mm (W) × 160 mm (D) (6 ¼ in [H] × 11 in [W] × 6 ¼ in [D]) (When the operation board angle is set to 60°)
Weight	About 1250 g (2.76 lb) (Including a handset, a handset cord, and a stylus pen)
PoE Interface	Compliant with IEEE 802.3af
Power Consumption	Stand-by mode: about 4.8 W Talk mode: about 5.0 W
Operating Environment	Temperature: 5 °C–40 °C (41 °F–104 °F)

Programming Items

User Options

Password

For details, see "Password Settings (Page 113)".

Parameter Name	Description	Value Range	Default Setting
Application Lock	Specify whether to use the Application lock feature.	Use/Don't use	Don't use
Current Password	Enter your current password for the Application lock.	1–16 characters	–
New Password	Enter a new password for the Application lock.	1–16 characters	–
Verify Password	Verify the new password.	1–16 characters	–

Display

For details, see "Display Settings (Page 113)".

Parameter Name	Description	Value Range	Default Setting
Display Color	Specify the display's color theme.	Dark Gray, Light Blue ^{*1}	Dark Gray
LCD Brightness	Select the brightness of the LCD screen.	1–5	3
Backlight Off Timer	Select the amount of time of inactivity before the LCD dims.	1, 3, 5, 10, 15, 30, 60 minutes	5 minutes
LCD Off Timer	Select the amount of time of inactivity before the LCD turns off after it has dimmed.	1, 5, 10, 30, 60, 120, 180, 300 minutes	30 minutes
Touch Screen Sound	Specify whether a sound is used to indicate each touch screen response.	On, Off	Off
Select Calls Screen	Select the display mode for the Calls screen.	Display Calls with Call List, Display Calls with Line Buttons	Display Calls with Line Buttons

*1 The Light Blue color scheme is easy to view and is recommended particularly for users with low vision.

Dial Number

For details, see "Dial Number Settings (Page 114)".

Parameter Name	Description	Value Range	Default Setting
Voice Mail Number	Edit the extension number for the voice mail system.	5 characters	–
Incoming Redirect Number	Edit the default phone number to redirect calls.	32 characters	–

Language

For details, see "Language Settings (Page 115)".

Parameter Name	Description	Value Range	Default Setting
Language	Select the on-screen language.	English-US, English-UK, French, French-CA, German, Spanish, Italian, Portuguese, Russian, Ukrainian	English-US

Directory List Select

For details, see "Directory List Select Settings (Page 115)".

Parameter Name	Description	Value Range	Default Setting
Local Directory	Specify whether to display the local directory.	Yes/No	Yes
Extension List	Specify whether to display the extension directory provided by the PBX.	Yes/No	Yes
Speed Dial	Specify whether to display the system speed dialing directory provided by the PBX.	Yes/No	Yes

IP Camera List

For details, see "IP Camera Settings (Page 116)".

Parameter Name	Description	Value Range	Default Setting
Camera Name	Edit the name for the camera.	1–20 characters	–
Camera Address	Edit the IP address for the camera.	Valid IP Address	–
Camera HTTP Port	Edit a HTTP port for the camera.	1–65535	80
Login Code	Edit the log-in code for the camera.	1–15 characters	–
Password	Edit the password for the camera.	1–15 characters	–
Codec	Specify the codec for the camera.	Motion JPEG, MPEG4	Motion JPEG
Camera RTSP Port (MPEG4 Only)	Edit a RTSP port for the camera.	1–65535	554

IP Camera Selection Buttons

For details, see "IP Camera Selection Buttons Settings (Page 117)".

Parameter Name	Description	Value Range	Default Setting
Camera Button 1	Select a camera from the drop down list to be shown on the Camera screen.	Currently registered cameras.	–
Camera Button 2	Select a camera from the drop down list to be shown on the Camera screen.	Currently registered cameras.	–
Camera Button 3	Select a camera from the drop down list to be shown on the Camera screen.	Currently registered cameras.	–
Camera Button 4	Select a camera from the drop down list to be shown on the Camera screen.	Currently registered cameras.	–

Web Page List

For details, see "Portal Settings (Page 117)".

Parameter Name	Description	Value Range	Default Setting
Name	Enter the name for the intranet Web page.	1–32 characters	–
URL	Enter the URL for the intranet Web page.	1–256 characters	–

Presence

For details, see "Presence Settings (Page 118)".

Presence Button Setting

Parameter Name	Description	Value Range	Default Setting
Button Name	Enter a name for the button.	1–16 characters	– ^{*1}
Presence	Specify whether to set the presence status.	Yes/No	Yes
Presence Mode	Specify the type of the presence status setting.	Same as Button Name, Available, (Enter Characters)	– ^{*1}
Presence Message	Enter a presence message.	1–16 characters	–
Forward/DND Settings	Specify whether to set FWD/DND.	Yes/No	No
FWD/DND External Mode	Specify the type of your presence for external calls.	Always (All), Busy, No answer, Busy/No answer, Do not disturb, Not Assigned	Not Assigned
Dial (FWD/DND External Number)	Enter the phone number to transfer calls for external calls.	32 digits	–
FWD/DND Internal Mode	Specify the type of your presence for internal calls.	Always (All), Busy, No answer, Busy/No answer, Do not disturb, Not Assigned	Not Assigned
Dial (FWD/DND Internal Number)	Enter the phone number to transfer calls for internal calls.	32 digits	–
Feature Number (check box)	Specify whether to set a Feature Number.	Yes/No	No
Feature Number	Enter a feature number.	32 digits	–

^{*1} For presence buttons 1–7, the default values are as follows:

- Button 1: Available
- Button 2: Will Return Soon
- Button 3: Gone Home
- Button 4: In a Meeting
- Button 5: In Conference
- Button 6: Urgent Only
- Button 7: Not at My Desk

Firmware Version

For details, see "Firmware Version (Page 165)".

Parameter Name	Description	Value Range	Default Setting
VoIP IPL Version	Displays the VoIP IPL Version.	–	–
VoIP Application Version	Displays the VoIP APP Version.	–	–
Application Loader Version	Displays the Application Loader Version.	–	–
Application Version	Displays the Application Version.	–	–

Administrator Options

Network—IP Address

These parameters are editable only during setup, after connecting the KX-NT400 to a PBX. On the **Options** screen, you can only view these parameters. For details about editing these parameters, see "IP Address Settings (Page 159)".

Parameter Name	Description	Value Range	Default Setting
DHCP	Specify whether DHCP is used.	Enable, Disable	Enable
VoIP IP Address	Enter the VoIP IP address when DHCP is disabled.	Valid IP Address	—
Application IP Address	Enter the application IP address when DHCP is disabled.	Valid IP Address	—
Subnet Mask	Enter the subnet mask when DHCP is disabled.	128.0.0.0–255.255.255.254	—
Default Gateway	Enter the default gateway address when DHCP is disabled.	Valid IP Address	—
PBX IP Address 1	Enter the PBX IP Address 1.	Valid IP Address	—
PBX IP Address 2	Enter the PBX IP Address 2.	Valid IP Address	—
PBX Change Time	Enter the length of the time before the failover process starts.	30–300 seconds	60 seconds

Network—IP Port

These parameters are editable only during setup, after connecting the KX-NT400 to a PBX. On the **Options** screen, you can only view these parameters. For details about editing these parameters, see "IP Port Settings (Page 160)".

Parameter Name	Description	Value Range	Default Setting
PTAP Server (IP Port 1)	Enter the IP port number for the PTAP server.	1024–65535	9300
PTAP Client (IP Port 1)	Enter the IP port number for the PTAP client.	1024–65535	9301
PTAP Server (IP Port 2)	Enter the IP port number for the PTAP server.	1024–65535	9300
PTAP Client (IP Port 2)	Enter the IP port number for the PTAP client.	1024–65535	9301

Network—QoS

These parameters are editable only during setup, after connecting the KX-NT400 to a PBX. On the **Options** screen, you can only view these parameters. For details about editing these parameters, see "Quality of Service (QoS) Settings (Page 161)".

Parameter Name	Description	Value Range	Default Setting
VLAN	Specify whether VLAN to be used.	Enable, Disable	Disable
VLAN ID (Primary Port)	Edit the VLAN ID when VLAN is enabled.	1–4094	1
VLAN Priority (Primary Port)	Edit the VLAN priority when VLAN is enabled.	0–7	7
VLAN ID (Secondary Port)	Edit the VLAN ID when VLAN is enabled.	1–4094	2
VLAN Priority (Secondary Port)	Edit the VLAN priority when VLAN is enabled.	0–7	0
Diffserv (Primary Port)	Specify whether Diffserv is used.	Enable, Disable	Disable
DS Field (Primary Port)	Edit the DS Field when Diffserv is enabled.	0–7.0–7	5.0

Maintenance

For more details, see "Maintenance (Page 162)".

Parameter Name	Description	Value Range	Default Setting
MAC Address (VoIP)	Shows the KX-NT400's VoIP MAC address.	–	–
MAC Address (Application)	Shows the KX-NT400's Application MAC address.	–	–

LDAP Server Settings

For more details, see "LDAP Server Settings (Page 121)".

Parameter Name	Description	Value Range	Default Setting
Display Name	Enter the LDAP server name to be displayed.	1–20 characters	–
Server Name/ Address	Enter the IP address of the LDAP server.	Valid IP Address	–
Port Number	Enter the port number to communicate with the LDAP server.	389, 636, 1024–65535	389
Server Logon	Select whether the LDAP server requires authentication.	–	–
Account Name	Enter the account name when the server requires authentication.	0–128 characters	–
Password	Enter the password when the server requires authentication.	1–128 characters	–

Dial Modification

For details about editing these parameters, see "Dial Modification Settings (Page 122)".

Parameter Name	Description	Value Range	Default Setting
Access Code for International Call	Edit the code to make international calls.	0–8 characters	00
International area code	Edit the international area code (e.g., England 44, Japan 81).	0–3 digits	–
Min. number of digits of an outside line:	Edit the minimum number of digits required to treat the dialed number as an outside telephone number.	1–32	7
Remove (0)	Specify whether the string "(0)" from a copied outside telephone number is to be deleted.	Yes/No	Yes
Leading Digits to Remove (1–10)	Edit the number or string to delete from a dialed number.	0–16 characters	See the Telephone Number Modification Default table below.
Add Number (1–10)	Edit the number or string to add on before a dialed number.	0–8 characters	
Additional No. to Add: (1–10)	Edit the number or string to add on before any outside call.	0–8 characters	

Telephone Number Modification Default

International area code = 1 (North America)

	Remove	Add
No.1–6	–	–
No.7	0	0
No.8	1	1
No.9	+1	1
No.10	+	011
Other		1

International area code = 7 (Russia)

	Remove	Add
No.1–6	–	–
No.7	0	0
No.8	8	8
No.9	+7	8
No.10	+	810
Other		8

International area code = other

	Remove	Add
No.1–8	–	–
No.9	+International area code	0
No.10	+	Access Code for International Call:
Other		–

Firmware Version Update

Firmware Version Update

The firmware can be updated only in the setup procedure after connecting the KX-NT400 to a PBX.

You can use a FTP server or an SD memory card to provide the new firmware data.

For details, see "Firmware Version Update (Page 163)".

Parameter Name	Description	Value Range	Default Setting
FTP Server Address	Enter the IP address for the FTP server.	Valid IP Address	0.0.0.0
FTP Server Control Port	Enter the port number for the FTP server.	21, 1024–65535	21
FTP User ID	Enter the user ID for the FTP server.	0–24 characters	–
FTP User Password	Enter the user password for the FTP server.	0–24 characters	–
FTP Path	Enter the path of the firmware data in the FTP server.	1–128 characters	C:/panasonic/ nt400
FTP File Name	Enter the file name of the firmware data.	1–24 characters	PNT400
VLAN	Specify whether VLAN is used.	Enable, Disable	Disable
VLAN ID	Enter the VLAN ID when VLAN is enabled.	1–4094	1
VLAN Priority	Enter the VLAN priority when VLAN is enabled.	0–7	7
File Name	Enter the file name and path of the firmware data in the SD memory card.	0–256 characters	–

SD Memory Cards

The KX-NT400 allows you to back up and restore your personal contacts and other settings using a CSV file. See "Data Maintenance (Page 166)" for details.

Important Information

To prevent data corruption or damage to the SD memory card, which may also affect the performance of the KX-NT400, keep the following in mind.

- Do not remove the SD memory card or Ethernet cable while backing up, formatting, or while restoring data for the card.
- Do not move or bump the KX-NT400 during backing up, formatting, or while restoring data on the SD memory card.
- Do not touch the contacts on the bottom of the SD memory card.
- To prevent damage to the KX-NT400, do not insert any memory card other than a compatible SD memory card.

Compatible SD Memory Cards

The KX-NT400 supports the following SD memory cards.

- SD, miniSD, and microSD memory cards
 - Use a miniSD or microSD adaptor when using miniSD or microSD memory cards, respectively, and always insert the miniSD or microSD memory card into the adaptor before inserting the adaptor into the KX-NT400.
- Cards with a capacity of 32 MB to 2 GB
- Class 2, Class 4, and Class 6 cards

Note

- The KX-NT400 does not support SD High-Capacity (SDHC), miniSDHC, and microSDHC memory cards.

Inserting and Removing SD Memory Cards

Insert the SD memory card as shown below.

To remove the card, gently push the card in to release it, and then remove the card.

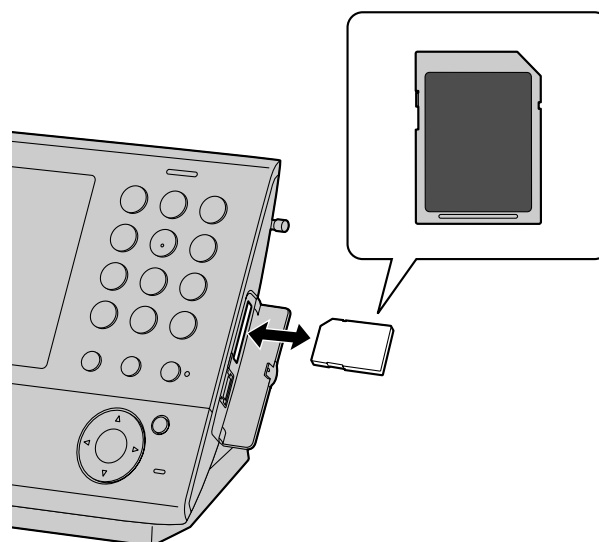

Write Protection (LOCK)

SD memory cards can be locked to prevent formatting, deleting, and recording. To lock an SD memory card, slide the switch on the side of the card to the "LOCK" position.

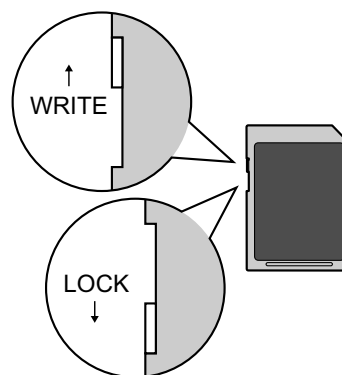

Formatting SD Memory Cards

CAUTION

- Do not remove the SD memory card, LAN cable, or AC adaptor while formatting an SD memory card.
- Do not move or bump the KX-NT400 while formatting an SD memory card.

Format the SD memory card before the first use. Formatting deletes all the data stored on the SD memory card. Back up important data before formatting the SD memory card.

To format the SD memory card, see "Maintenance screen (1/4) (Page 166)".

Note

- When formatting cards with a computer, select the FAT format.
- When an SD memory card is formatted, all information on the card is deleted.

Troubleshooting

If you are experiencing trouble, refer to the information in this section. Before troubleshooting, confirm all connections (see "Connections (Page 147)") and confirm that the PoE (Power over Ethernet) device or power outlet to which the KX-NT400 is connected to is receiving power.

Common Issues and Solutions

General Use

Issue	Possible Cause & Solution	Reference
The display is blank.	<ul style="list-style-type: none"> The KX-NT400 is not receiving power. <ul style="list-style-type: none"> → The KX-NT400 is not designed to function when there is a power failure. Make sure that the device supplying PoE is receiving power and that the Ethernet cable is properly connected. If an AC adaptor is connected, confirm that the AC adaptor is connected and receiving power. 	Page 147
The display is not shown well.	<ul style="list-style-type: none"> The LCD's brightness is too low. <ul style="list-style-type: none"> → Adjust the LCD's brightness. 	Page 113
The KX-NT400 is not performing properly.	<ul style="list-style-type: none"> Cables or cords are not connected properly. <ul style="list-style-type: none"> → Check all connections. 	Page 147
	<ul style="list-style-type: none"> Your connection settings are incorrect. <ul style="list-style-type: none"> → Consult your administrator to confirm that your settings are correct. → If the problem persists, consult your dealer. 	Page 157
	<ul style="list-style-type: none"> An error has occurred. <ul style="list-style-type: none"> → Reset the KX-NT400. When using PoE, disconnect the Ethernet cable, wait 10 seconds, and then connect the Ethernet cable again. If using an AC adaptor, disconnect the AC adaptor from the power outlet, wait 10 seconds, and then connect the AC adaptor again. 	Page 168
I cannot press the buttons on the screen.	<ul style="list-style-type: none"> The screen was not calibrated properly. <ul style="list-style-type: none"> → Perform calibration again. You can perform the calibration from the Display Settings screen. 	Page 113
I cannot cancel the Application lock even when I enter the correct password.	<ul style="list-style-type: none"> Your extension has been locked by the PBX. <ul style="list-style-type: none"> → To unlock your extension, the PIN and PIN lock for your extension must be cleared. For details, consult your manager. 	—
The KX-NT400 does not respond when buttons are pressed.	<ul style="list-style-type: none"> The extension dial lock is set. <ul style="list-style-type: none"> → Unlock the KX-NT400. 	Page 97
	<ul style="list-style-type: none"> The KX-NT400 is connected to an eXtra Device Port. <ul style="list-style-type: none"> → System programming is required. Consult your dealer. 	—



Issue	Possible Cause & Solution	Reference
Some features do not work.	<ul style="list-style-type: none"> System management may restrict certain features. → Consult your manager. 	—
	<ul style="list-style-type: none"> The feature numbers have changed. → Confirm the revised number and try again. 	Page 89
Even though following the manual instructions, none of the operations work.	<ul style="list-style-type: none"> The Intercom line was not seized. → The seized line, when going off-hook, was changed by personal setting. 	Page 133
	<ul style="list-style-type: none"> In the manual, going off-hook means an Intercom line is seized. → If the setting has been changed, on the Programming screen, press INT' or a PDN button after going off-hook and follow the instructions. 	Page 125
The KX-NT400 does not work using the personal settings or with other settings. (One-touch dialing, forwarding destination, etc.)	<ul style="list-style-type: none"> The settings for the KX-NT400 have been changed via the PC Maintenance Console or changes have been made to the PBX's configuration. → Restart the KX-NT400 manually. 	Page 168
	<ul style="list-style-type: none"> The previous settings have not been cleared. → Clear the settings, and then program your desired settings again. 	Page 131 Page 125
I cannot remember the feature numbers.	<ul style="list-style-type: none"> The feature numbers may have been changed. → Consult your administrator. → Ask your dealer to change the feature numbers for easier use. 	Page 89
I forgot the password.	<ul style="list-style-type: none"> Ask the manager to assist you. 	—
The background music started suddenly.	<ul style="list-style-type: none"> Turn off the music. 	Page 90
The date and time are not correct.	<ul style="list-style-type: none"> The KX-NT400 obtains its date and time information from the PBX. Therefore, the date and time settings on the PBX are incorrect. → Consult your administrator. 	—
The Message/Ringer lamp is lit.	<ul style="list-style-type: none"> Another extension left you a message waiting indication while you were on the phone or away from your desk. → Check the message waiting message. 	Page 76
The Calls screen or the Feature Key screen (in Call List mode) indicates that there are missed calls, even though I viewed the Missed call log.	<ul style="list-style-type: none"> On the PBX, the Incoming Call Log Memory setting for the KX-NT400 is not set to 0. → Use the PC Maintenance Console to change the Incoming Call Log Memory setting on the PBX to 0. For details, see the PBX's documentation or consult your administrator. 	Page 157
An SDN button on my extension does not work.	<ul style="list-style-type: none"> A PDN button is not assigned on the extension corresponding to your SDN button. → Create a PDN button on the desired extension. 	Page 102

Making and Receiving Calls

Issue	Possible Cause & Solution	Reference
I cannot make calls.	<ul style="list-style-type: none"> The service for your telephone is turned off in the connected PBX. <ul style="list-style-type: none"> → If the sub-display on the Calls screen or the Feature Key screen (in Call List mode) is blank, the service status for your telephone is turned off in the PBX. Consult your administrator to change the service status. 	Page 55 Page 37
	<ul style="list-style-type: none"> The phone number was entered incorrectly. <ul style="list-style-type: none"> → Confirm that you have entered the phone number of the other party correctly. → Consult your administrator. 	Page 62
	<ul style="list-style-type: none"> The screen was changed during a programming operation. Under some conditions, changing the screen without exiting programming mode can cause the KX-NT400 to not be able to make and receive calls. This problem can occur when programming the telephone via the Calls screen, the Feature Key screen (in Call List mode), or the Programming screen. <ul style="list-style-type: none"> → Wait a while for programming mode to exit automatically. 	—
I cannot redial by selecting an entry in a call log.	<ul style="list-style-type: none"> The number you are trying to redial is too long. <ul style="list-style-type: none"> → If the dialed number contains more than 32 digits for an internal call, it cannot be redialed correctly. 	—
I cannot make long distance calls.	<ul style="list-style-type: none"> Your telephone service does not allow you to make long distance calls. <ul style="list-style-type: none"> → Make sure that you have subscribed to your telephone company's long distance service. 	—
	<ul style="list-style-type: none"> If the KX-NT400 is connected to a PBX, your extension may not be configured to make long distance phone calls. <ul style="list-style-type: none"> → Contact your administrator. 	—
The KX-NT400 does not ring when a call is received.	<ul style="list-style-type: none"> The ringer is turned off. <ul style="list-style-type: none"> → Press Δ (UP) while a call is being received, or change the ringer volume setting. 	Page 58
I cannot make an outside call using the One-touch dialing button or speed dialing.	<ul style="list-style-type: none"> A line access number was not stored. <ul style="list-style-type: none"> → On the Dial Modification Settings screen, enter the line access number in the Additional No. to Add: setting. 	Page 122
While talking to an outside party, the line is disconnected.	<ul style="list-style-type: none"> The time limit has run out. <ul style="list-style-type: none"> → Consult your dealer to extend the time limit, if necessary. 	—
Redialing does not function.	<ul style="list-style-type: none"> The stored number was more than 32 digits or was an extension number. 	Page 66
I cannot send a call waiting tone to the dialed extension.	<ul style="list-style-type: none"> The other party has not set the Call Waiting feature. The other party has set Data Line Security. 	—

Issue	Possible Cause & Solution	Reference
When forwarding a call, Hold Recall is heard when selecting a destination on the Contacts screen.	<ul style="list-style-type: none"> The Extension First Digit Timer setting of the PBX has not been set to 250 s. <ul style="list-style-type: none"> → Using the PBX's PC Maintenance Console, set the Extension First Digit setting to 250 s. For more details, refer to the PBX's documentation or consult your administrator. 	—

Sound Quality

Issue	Possible Cause & Solution	Reference
The other party cannot hear my voice.	<ul style="list-style-type: none"> The KX-NT400 is muted. <ul style="list-style-type: none"> → If  is displayed, press  to turn off the mute feature. 	Page 72
	<ul style="list-style-type: none"> Objects are obstructing the microphone. <ul style="list-style-type: none"> → Do not obstruct the KX-NT400 during calls. Keep your hands, as well as common objects such as folders, cups, and coffee pots away from the KX-NT400 during calls. 	—
Sound cuts out; I can hear myself through the speaker.	<ul style="list-style-type: none"> If using DSL service, a device connected between the KX-NT400 and the telephone jack is causing interference. <ul style="list-style-type: none"> → Connect the KX-NT400 directly to the telephone jack if possible, and/or consult your DSL service provider. 	—
	<ul style="list-style-type: none"> You are too far away from the microphone. <ul style="list-style-type: none"> → Try speaking closer to the microphone. 	—
	<ul style="list-style-type: none"> The environment is not suited to speakerphone calls. <ul style="list-style-type: none"> → Do not use the KX-NT400 within 2 m of projectors, air conditioning devices, fans, or other audible or electrical noise emitting devices. → If using the KX-NT400 in a room with windows, close the curtains or blinds to prevent echoes. → Use the KX-NT400 in a quiet environment. 	—
	<ul style="list-style-type: none"> The KX-NT400 was moved during a call. <ul style="list-style-type: none"> → Do not move the KX-NT400 while on a call. 	—
	<ul style="list-style-type: none"> Objects are obstructing the microphone. <ul style="list-style-type: none"> → Do not obstruct the KX-NT400 during calls. Keep your hands, as well as common objects such as folders, cups, and coffee pots away from the KX-NT400 during calls. 	—
	<ul style="list-style-type: none"> The other party is using a half-duplex speakerphone. <ul style="list-style-type: none"> → If the other party is using a half-duplex speakerphone, sound may cut out occasionally during calls. For best performance, the other party should use a full-duplex speakerphone. 	—

SD Memory Cards

Issue	Possible Cause & Solution	Reference
I cannot record to the SD memory card.	<ul style="list-style-type: none"> The SD memory card is not compatible with the KX-NT400. → Make sure that you are using a compatible SD memory card. (SDHC, miniSDHC, and microSDHC Memory Cards are not compatible with the KX-NT400.) 	—
	<ul style="list-style-type: none"> The SD memory card is not formatted or was not formatted properly. → Format SD memory cards before the first use. 	—
	<ul style="list-style-type: none"> The SD memory card was not inserted properly. → Make sure that the SD memory card is inserted properly by gently pushing it securely but gently toward the back of the SD memory card slot. 	—

Contact List

Issue	Possible Cause & Solution	Reference
I cannot add or edit entries to the contact list.	<ul style="list-style-type: none"> There are 300 entries in the contact list. → The contact list is full. Delete any unnecessary entries. 	Page 109
The ringing icons do not appear on the Contacts screen.	<ul style="list-style-type: none"> The ringing icons (for example, ) do not appear if you use the default settings. → Using the PC Maintenance Console, set the DSS key mode for Incoming Call setting to "ON or Flash". For more details, refer to the PBX's documentation or consult your administrator. 	—
While I am adding or editing contact list entries, the KX-NT400 turns off the LCD.	<ul style="list-style-type: none"> The phone has not been touched for the set duration of the LCD Off Timer. → If no buttons are pressed and the phone is not used for the set duration while programming the KX-NT400, the LCD will turn off. 	Page 114

Camera

Issue	Possible Cause & Solution	Reference
I cannot connect to a camera.	<ul style="list-style-type: none"> The settings for the camera are not configured correctly. → Confirm the camera's settings in the IP Camera settings. You have not registered any cameras. → Register a camera in the IP Camera settings. 	Page 116
	<ul style="list-style-type: none"> The settings for a camera registered to a contact are not configured correctly. → Confirm the camera settings in the contact's settings. 	Page 109
	<ul style="list-style-type: none"> The camera is not functioning correctly. → Refer to the documentation for the camera or consult your administrator. 	—

Issue	Possible Cause & Solution	Reference
The video feed does not display.	<ul style="list-style-type: none"> The camera's Codec setting on the KX-NT400 is set to MPEG4, but the camera's streaming format is set to a different format. <ul style="list-style-type: none"> → Access the camera's settings, and set the video streaming format to MPEG-4/MJPEG. For details about changing the camera's settings, see the camera's documentation. 	—
The video feed is delayed, or the picture is blocky.	<ul style="list-style-type: none"> The video is being streamed from the camera in MPEG4 format with the default settings. <ul style="list-style-type: none"> → In the camera's settings, use the following, recommended settings for streaming MPEG4 video: <ul style="list-style-type: none"> • For QVGA video (320 × 240), set the frame rate to 15 fps or less. • For QVGA video (320 × 240), set the maximum bit rate to 256 kbps. For details about changing the camera's settings, see the camera's documentation. 	—
Some or all of the controls are unavailable.	<ul style="list-style-type: none"> The camera you are connected to does not support these functions. <ul style="list-style-type: none"> → Refer to the documentation for the camera. Certain functions are disabled for security reasons. <ul style="list-style-type: none"> → Consult your administrator. 	—
Even after I select a programmed position, "Preset" still appears in the Position drop-down list.	<ul style="list-style-type: none"> "Preset" is always displayed in the Position drop-down list, even if you have selected a programmed position. 	—

Note

- For other issues regarding cameras, refer to the documentation for the camera or consult your administrator.

Chat

Issue	Possible Cause & Solution	Reference
I cannot initiate a chat.	<ul style="list-style-type: none"> The other user is not using a KX-NT400 or software program that supports the chat feature, such as Communication Assistant. <ul style="list-style-type: none"> → You can confirm whether the other user is using a KX-NT400 or Communication Assistant from the icon displayed on the Contacts screen. 	Page 33
	<ul style="list-style-type: none"> The other user is using Communication Assistant but is connected through CA Server. <ul style="list-style-type: none"> → You cannot chat with CA users connected through CA Server. 	—
	<ul style="list-style-type: none"> You are already participating in a chat session. <ul style="list-style-type: none"> → You can chat with only 1 person at a time. 	—

Issue	Possible Cause & Solution	Reference
I cannot enter characters.	<ul style="list-style-type: none"> You have already entered the maximum of 255 characters for 1 message. → Send the current message and then enter more characters, or delete some characters in the current message. 	—

Portal

Issue	Possible Cause & Solution	Reference
I cannot connect to a Web site.	<ul style="list-style-type: none"> The URL you specified is incorrect. → Confirm the URL in the Portal settings, and then try connecting again. 	Page 117
	<ul style="list-style-type: none"> You specified a domain name (e.g., "www.panasonic.com") in the URL. Because the KX-NT400 does not support DNS lookup, you can only access URLs by IP address. → Change the URL to specify the IP address for the desired Web site. 	Page 117
	<ul style="list-style-type: none"> The connection to the Web site might be inaccessible because you need to access it through a proxy server. The KX-NT400 does not support access through a proxy server. → Consult your administrator. 	—
When I tap a link for a phone number, the number is not dialed correctly.	<ul style="list-style-type: none"> The number is invalid. → Tap the link for the phone number while on-hook and confirm the number in the Dial window. If the number appears valid, but is still dialed incorrectly, try dialing it from another phone. If the number is dialed correctly from another phone, check the dial modification settings or consult your administrator. 	Page 122
	<ul style="list-style-type: none"> The dial modification settings are configured incorrectly. → Confirm that the dial modification settings are configured correctly. If you are unsure whether they are correct, consult your administrator. 	Page 122
	<ul style="list-style-type: none"> If you are dialing an outside number, a CO line might not be available. → Wait a while, and then try again. 	—
When I tap the Home button, nothing happens.	<ul style="list-style-type: none"> You have not specified a homepage. (If you have imported settings from an SD memory card, no homepage will be set, even if one was set when the settings were exported.) → Set a homepage in the Portal settings. 	Page 117

PT-Programming

Issue	Possible Cause & Solution	Reference
While I am programming the KX-NT400, the KX-NT400 turns off the LCD.	<ul style="list-style-type: none"> The phone has not been touched for the set duration of the LCD Off Timer. <ul style="list-style-type: none"> → If no buttons are pressed and the phone is not used for the set duration while programming the KX-NT400, the LCD will turn off. 	—
I cannot program the KX-NT400.	<ul style="list-style-type: none"> You are on a call. <ul style="list-style-type: none"> → Program the KX-NT400 once you have finished the call. 	—

Bluetooth Headsets

Issue	Possible Cause & Solution	Reference
I cannot have a conversation using the Bluetooth headset.	<ul style="list-style-type: none"> Make sure that the headset is properly registered to the module. Make sure that the headset is properly charged according to the manual of the headset. Remove the wired headset from the headset jack. Priority is given to the wired headset when both are connected. 	—
I cannot register, de-register, or confirm the ID of the Bluetooth headset.	<ul style="list-style-type: none"> Make sure that the module is properly installed in the KX-NT400. 	—

USB Devices

Issue	Possible Cause & Solution	Reference
The USB device I connected does not work.	<ul style="list-style-type: none"> The device is not supported by the KX-NT400. <ul style="list-style-type: none"> → The KX-NT400 only supports USB keyboards. 	—
The USB keyboard I connected does not work.	<ul style="list-style-type: none"> The keyboard is not connected properly. <ul style="list-style-type: none"> → Confirm the connection. 	Page 147

Firmware Update

Issue	Possible Cause & Solution	Reference
I have problems upgrading the firmware from an FTP server.	<ul style="list-style-type: none">• The settings for connecting to the FTP server are incorrect.<ul style="list-style-type: none">→ Confirm that the server address and port number (default 21) are correct.→ Confirm that the user ID, password, path, and file name are entered correctly.	Page 163
	<ul style="list-style-type: none">• The FTP server is not responding or is too busy to accept new connections.<ul style="list-style-type: none">→ Try performing the upgrade again later.→ Consult your network administrator.	—

Error Messages

During operation, error messages might appear on the KX-NT400. The following table lists these messages and possible causes and solutions.

Message	Possible Causes & Solutions	Reference
The password you inputted was incorrect. Please try again.	<ul style="list-style-type: none"> The password you entered is not correct. → Confirm the password and try again. 	—
SD card doesn't exist.	<ul style="list-style-type: none"> SD card was removed during access. → Do not remove the SD memory card while it is being accessed. 	—
Cannot access SD card.		
SD Card or folder not found.		
The firmware upgrade failed because the file does not exist.		
SD card format is invalid.	<ul style="list-style-type: none"> The SD memory card is not formatted in FAT format. → Format the SD memory card with the KX-NT400. You attempted to format an SDHC memory card. → SDHC memory cards are not compatible with the KX-NT400. Use a compatible SD memory card. 	Page 182 Page 181
Unsupported SD Card format.		
Can't access the file.	<ul style="list-style-type: none"> The SD memory card cannot be used for backing up because it is full. → Delete unneeded data. 	—
Cannot access SD Card or SD Card is read-only.	<ul style="list-style-type: none"> The switch on the side of the SD memory card is set to the LOCK position. → Remove the card, slide the switch to the WRITE position, and then insert the card again. 	Page 181
Check a Network cable.	<ul style="list-style-type: none"> The Ethernet cable is not connected. → Check all connections. 	Page 147
DHCP server is not found.	<ul style="list-style-type: none"> The KX-NT400 cannot receive IP settings from the DHCP server. → Consult your administrator. 	—
Data Acquisition Failed.	<ul style="list-style-type: none"> Data could not be correctly acquired from the PBX. → Follow the instructions to restart the KX-NT400. 	—
Firmware folder does not exist in SD card.	<ul style="list-style-type: none"> The folder that the KX-NT400 uses does not exist on the SD memory card. → On the SD card, create the following folder: <code>\private\meigroup\pcc\pbxpt\nt400</code> 	—
The firmware file has not been downloaded. Please check the settings and download the firmware first.	<ul style="list-style-type: none"> The file necessary for upgrading the firmware has not been downloaded. → On the Firmware Version Update screen, press Start next to Download to begin the downloading the firmware upgrade file. 	Page 163

Message	Possible Causes & Solutions	Reference
Connection to the FTP server cannot be established.	<ul style="list-style-type: none"> The file necessary for upgrading the firmware could not be downloaded from the FTP server. → Check that the FTP server settings are correct. 	Page 163
FTP download failed.		
Firmware file format is invalid.	<ul style="list-style-type: none"> The firmware could not be upgraded using the firmware upgrade file that was downloaded from the FTP server. 	—
Firmware file is invalid.		
The SD Card format does not support SD Cards larger than 2G Bytes.	<ul style="list-style-type: none"> The SD memory card is not compatible with the KX-NT400. → Use an SD memory card that is compatible with the KX-NT400. 	Page 181
The SD Card format feature does not support SD Cards smaller than 32M Bytes.		
Failed to connect to the LDAP server.	<ul style="list-style-type: none"> The KX-NT400 could not connect to the LDAP server. → Check the settings for the LDAP server. 	Page 121
Failed to connect to the IP camera.	<ul style="list-style-type: none"> The KX-NT400 could not connect to a network camera. → Check the settings for the network camera. 	Page 116
Password is locked. Please contact your manager of PBX.	<ul style="list-style-type: none"> Your extension has been locked by the PBX. → To unlock your extension, the PIN and PIN lock for your extension must be cleared. For details, consult your manager. 	—
NT400 skipped refreshing the PBX Data because PBX was not ready.	<ul style="list-style-type: none"> The KX-NT400 could not download system speed dialing directory and extension number directory from the connected PBX. → Consult your administrator. 	—

Error Codes

You can view the system error messages (error codes) on the **Error Log** screen.

To access the Error Log screen

1. Press the **Options** tab > **Administrator Options** > **Error Log**.

Error code	Subcode	Probable Cause	Solution
0x1001	0x0000	Sub CPU malfunction	Consult your network administrator.
0x1002	0x0000	Sound hardware malfunction	
0x1003	0x0000	Flash memory malfunction	
0x1004	0x****	PHY (network control IC) error	
0x1005	0x0000	SDRAM error	
0x1006	0x0000	SRAM error	
0x1007	0x0000	Sub CPU malfunction for Self Labeling	
0x1008– 0x1009	0x0000	Communication error between KX-NT400 CPUs.	If this error is displayed frequently, consult your network administrator.
0x1051	0x0000	PBX software version error	Consult your network administrator.
0x2001	0x****	Unexpected error	If this error is displayed frequently, consult your network administrator.
0x2002– 0x2003	0x0000	Transmission error	Check with the network administrator whether there is a problem with the LAN. If this error is displayed frequently, consult your network administrator.
0x2004	0x0000	KX-NT400 not registered	Check the registration status of the KX-NT400.
0x2005	0x0000	Connection refused by the PBX	
0x2006	0x****	IP address lease time from DHCP server has expired. IP address lease renewal was refused by DHCP server.	Consult your network administrator.
0x2007	0x0000	Communication error with sub CPU	If this error is displayed frequently, consult your network administrator.
0x2008	0x0000	Sound hardware control error	
0x2009	0x****	Error information from the PBX (MGCP server)	Consult your network administrator.
0x2010	0x0000	Communication error with sub CPU for Self Labeling	If this error is displayed frequently, consult your network administrator.
0x2011– 0x2015	0x0000	Communication error between KX-NT400 CPUs.	If this error is displayed frequently, consult your network administrator.
0x3001	0x0000	Communication error with sub CPU	If this error is displayed frequently, consult your network administrator.
0x3002	0x0000	Sound hardware control error	
0x3003	0x****	IP address lease renewal was refused by DHCP server	Consult your network administrator.
0x3100	0x0000	Bluetooth hardware error	Repair or replace the Bluetooth wireless headset.

Error code	Subcode	Probable Cause	Solution
0x6000– 0x6003	0x****	Software error	If this error is displayed frequently, consult your network administrator.
0x6100	0x****	Communication error between KX-NT400 CPUs.	Consult your network administrator.
0x6200– 0x6201	0x****	Communication error between KX-NT400 CPUs.	If this error is displayed frequently, consult your network administrator.
0x6202	0x****	Device error	Consult your network administrator.
0x7000	0x****	Transmission error	If this error is displayed frequently, consult your network administrator.
0x7001– 0x7006	0x****	Device error	Consult your network administrator.
0x7007	0x****	SD card error	Check SD card
0x7008– 0x700B	0x****	Device error	Consult your network administrator.
0x700C– 0x700D	0x****	SD card error	Check SD card
0x700E	0x****	Device error	Consult your network administrator.
0x700F	0x****	Acquiring the initial data from the PBX failed. KX-NT400 was initialized with values for European PBXs.	If this error is displayed frequently, consult your network administrator.
0x7010– 0x7018	0x****	Software error	If this error is displayed frequently, consult your network administrator.
0x7019	0x****	1) Software error 2) Import error	1) Check the Import file 2) Consult your network administrator.
0x7100– 0x7101	0x****	Communication error between KX-NT400 CPUs.	If this error is displayed frequently, consult your network administrator.
0x7102– 0x710C	0x****	Software error	If this error is displayed frequently, consult your network administrator.
0x7200	0x****	Version update error	If this error is displayed frequently, consult your network administrator.
0x8001– 0x8002	0x****	Error information from the PBX (CSTA server)	If this error is displayed frequently, consult your network administrator.
0x8003	0x****	Connection refused by the PBX	Consult your network administrator.
0x8004	0x****	Extension number changed in PBX	Consult your network administrator.
0x8005	0x****	Error information from the PBX (CSTA server)	If this error is displayed frequently, consult your network administrator.
0x8006	0x****	Transmission error	If this error is displayed frequently, consult your network administrator.

Error code	Subcode	Probable Cause	Solution
0x8007	0x****	1) The KX-NT400's extension is already in use by another user. 2) Connection refused by the PBX	1) Consult your network administrator. 2) If this error is displayed frequently, consult your network administrator.
0x8008– 0x8009	0x****	Connection refused by the PBX	If this error is displayed frequently, consult your network administrator.
0x8101	0x****	Communication error between KX-NT400 CPUs.	Consult your network administrator.
0x8102	0x****	Import error	If this error is displayed frequently, consult your network administrator.
0x8103– 0x8104	0x****	Communication error between KX-NT400 CPUs.	Consult your network administrator.
0x8105	0x****	PBX system data is locked.	Consult your network administrator.
0x8108	0x****	Transmission error	If this error is displayed frequently, consult your network administrator.

Index

A

- Absent Message 89, 128
 - Feature clear 131
 - Remote setting 103
- AC adaptor 17
 - Connections 147
- Accented characters 60
- Access Code for International Call 122, 178
- Access Voice Mail (button) 30
- Accessories 17
- Account (flexible button) 138
- Account Code Entry 89
- Account Name 177
- Add Number 123, 178
- Additional No. to Add: 123, 178
- Administrator Options 121
 - Dial Modification Settings 122
 - LDAP Server Settings 121
- Administrator Options (button) 57
- Alternate Calling—Ring/Voice 89
- Alternate Receiving—Ring/Voice 127
 - Feature clear 131
- Angle adjust button 21
- Answer (button) 42
- Answering calls 67
 - Answering calls (flexible button) 140
- Application IP Address 176
- Application Loader Version 175
- Application Lock 75, 171
 - Lock/Unlock (button) 31
- Application Version 175
- Arrow buttons 59
 - Display more call operations 41
 - for displaying more tabs 28
 - for scrolling 33
 - For scrolling the Calls screen 41
 - Scroll chat log 52
 - Scrolling the call log 48
- Auto Answer 67
 - Set/cancel (button) 31
- Automatic Call Waiting 128
 - Feature clear 131
- Automatic Callback Busy 87, 89
- Automatic Line Access 90

B

- Back cover 21
- Back view 21
- Background Music (BGM) 90, 129
 - Feature clear 131
- Backlight Off Timer 171
- BGM 90
- Bluetooth
 - Connecting a headset 153
 - Connection status 31
 - Headset operation 155
 - Installation 153
 - Socket 21

- Bluetooth Module 17
- Bluetooth Wireless Headset Registration 129
- Bluetooth Wireless Headset Removal 129
- Bottom view 22
- Button Name 174

C

- Cables, Connections 148
- Call (button) 53
- Call Forwarding (FWD) 79, 91
 - Advanced settings 80
 - Presence status 120
 - Remote setting 103
 - Simple settings 79
- Call Forwarding drop-down list 30
- Call Forwarding to Voice Mail (Voice Mail Integration) 92
- Call Forwarding/Do Not Disturb Settings 120
- Call Hold 69, 92
 - Retrieve 69
- Call Log
 - Delete data 166
 - Flexible button 138
 - Icons 48
 - Incoming 47
 - Log entry 48
 - Missed 47
 - Outgoing 47
- Call Log Delete 166
- Call Log for ICD Group (flexible button) 139
- Call Log screen 47
- Call Log tab 27
- Call Monitor 93
- Call Park 70, 93
 - Automatic 70, 138
 - Manual 70, 138
- Call Pickup
 - Call Pickup Deny 93
 - Deny 129
 - Direct Call Pickup 93
 - Group Call Pickup 93
- Call Splitting 71, 94
- Call status icons 41
- Call Transfer 71, 94
- Call Waiting 94
 - Answering 70, 94
 - Answering from the telephone company 94
 - Automatic 128
 - Manual 128
 - Receiving 94
 - Sending 86, 94
- Call Waiting Tone Type Selection 128
 - Feature clear 131
- Call, Doorphone 96
- Calling Line Identification Presentation (CLIP) 126
 - Feature clear 131
- Calling Line Identification Restriction (CLIR) 92, 126
 - Feature clear 131
- Calling Line Identification Restriction (CLIR) Button 140
- Calling/Connected Line Identification Presentation (CLIP/ COLP) 93, 126
- Calls screen 37
 - Call List mode 40

- Line Buttons mode 37
 - Calls tab 27
 - Camera 81
 - Center point 82
 - Changing the angle 82
 - Contact integration 81
 - Control 81
 - Doorphone integration 81
 - Full-screen mode 82
 - Home position 82
 - Location list 81
 - Opening door 82
 - Pan 82
 - Pan scan 82
 - Position list 82
 - Selecting 81
 - Selection buttons 81
 - Tilt 82
 - Tilt scan 82
 - Zoom 81
 - Camera Address 172
 - Camera Button 173
 - Camera HTTP Port 172
 - Camera Name 172
 - Camera RTSP Port (MPEG4 Only) 172
 - Camera screen 49
 - Camera tab 28
 - Cancel button 60
 - CANCEL button 18
 - Center point (Camera) 82
 - Character table 145
 - Option mode 146
 - Standard mode 146
 - Switch (button) 35
 - Switching 60
 - Chat 83
 - Call button 83
 - Calling chat participant 83
 - Clear button 83
 - Close button 83
 - Receiving request 83
 - Send button 83
 - Start 83
 - Chat Log (Export Only) 168
 - Chat Log Delete 166
 - Chat screen 52
 - Chat tab 28
 - Checking new messages
 - Message Waiting 76
 - SVM, Simplified Voice Message 76
 - Voice Mail 77
 - Cleaning 169
 - Clear (button) 53
 - Clearing Flexible Buttons 144
 - CLIP/COLP, Calling/Connected Line Identification Presentation 93
 - CLIR, Calling Line Identification Restriction 92
 - Close (button) 53
 - CO Line Group Access 94
 - Codec 172
 - COLR, Connected Line Identification Restriction 95
 - Conference 95
 - Flexible button 138
 - Conference call 73
 - Establishing 73
 - Leaving (Unattended conference) 74
 - Removing a participant 74
 - Conference, Unattended 95
 - Connected Line Identification Presentation (COLP) 126
 - Feature clear 131
 - Connected Line Identification Restriction (COLR) 95
 - Feature clear 131
 - Flexible button 141
 - Connections 147
 - Contacts
 - Add button 32
 - Adding from call log 108
 - Adding from LDAP directory 109
 - Adding from PBX 109
 - Door settings 111
 - Editing 109
 - Phone settings 110
 - Sensor settings 112
 - Contacts screen 32
 - Contacts tab 27
 - Copy (text) 60
 - CTI (flexible button) 141
 - Ctrl key 60
 - Current Password 171
 - Cut (text) 60
- ## D
- Data Export 167
 - Data Import 167
 - Data Line Security 95
 - Feature clear 131
 - Data Maintenance 166
 - DC jack 22
 - Default Gateway 176
 - Deleting contact 109
 - Deny, Call Pickup 93
 - Deny, Executive Busy Override 97
 - Details for Contacts 109
 - DHCP 176
 - Dial
 - FWD/DND External Number 174
 - FWD/DND Internal Number 174
 - Dial key 61
 - Dial Modification 178
 - Settings 122
 - Dial Modification Settings 122, 167
 - Example 122
 - Dial Number Settings 114, 167, 171
 - Dial Tone Transfer 95
 - Dial window (button) 35
 - Dialing 62
 - Pre-dial 62
 - Diffserv
 - Primary Port 177
 - Direct Inward System Access (DISA) 96
 - Direct Station Selection (DSS) (flexible button) 136
 - Directory drop-down list 32, 35
 - Directory List Select 172
 - Directory List Select Settings 115, 167
 - DISA message 103

DISA, Direct Inward System Access 96
 Disconnect (button) 35
 Display 171
 Display Calls with Call List 114
 Display Calls with Line Buttons 114
 Display Color 171
 Display Language Selection 126
 Display Lock 98, 130
 Display Name 177
 Display Settings 113, 167
 Display Switching Mode 126
 Feature clear 131
 DND → Do Not Disturb 79, 96, 97
 Advanced settings 80
 Drop-down list 30
 Override 96
 Remote setting 103
 Door open (button) 51
 Doorphone
 Call 96
 Opening 82, 96
 DS Field
 Primary Port 177

E

EFA (External Feature Access) 88
 Electronic Station Lockout → Extension Dial Lock 130
 Enhanced Walking Extension 97
 ENTER button 18
 Entering Characters 145
 Error codes 193
 Error Log 166
 Error messages 192
 Ethernet, Connections 147
 Executive Busy Override 87, 97
 Executive Busy Override Deny 97, 129
 Feature clear 131
 Extended keyboard 60
 Extension Dial Lock 97, 103, 130
 Extension Dial Lock Clear 98
 Extension Feature Clear 98
 Extension List 172
 Extension number display 57, 58
 Extension PIN (Personal Identification Number) 98, 130
 External Background Music (BGM) 98
 External Feature Access (EFA) 88, 99
 Flexible button 138
 External Relay 99
 External Sensor 99

F

Feature (button) 31
 Feature clear 131
 Feature Key screen 55
 Feature number
 and Presence status 120
 Feature Number 174
 Feature Number (check box) 174
 Feature Programming 126
 File Name 180
 Firmware Ver. Update Settings 167

Firmware Version 165, 175
 Firmware Version Update 163, 180
 Flash 88
 Flexible Buttons
 Programming 133
 Flexible buttons (Feature Key screen) 38, 56
 Flexible Buttons, Clear 144
 Forced Answerback Selection 127
 Feature clear 131
 Forward/DND Settings 174
 Front View 18
 FTP File Name 180
 FTP Path 180
 FTP Server Address 180
 FTP Server Control Port 180
 FTP User ID 180
 FTP User Password 180
 Full-screen mode 82
 Button 50
 FWD → Call Forwarding 79
 FWD N/A Timer 129
 Feature clear 131
 FWD, Call Forwarding 91
 FWD, Call Forwarding to Voice Mail 92
 FWD/DND
 Both calls 137
 Feature clear 131
 Intercom calls 137
 Outside calls 137
 FWD/DND drop-down list 30
 FWD/DND External Mode 174
 FWD/DND Internal Mode 174

G

Group FWD—Both calls (flexible button) 137
 Group FWD—Intercom calls (flexible button) 138
 Group FWD—Outside calls (flexible button) 137
 Group Paging 99
 Group-CO (G-CO) (flexible button) 135

H

Handset 17, 20
 Connections 149
 Hooking on operation board 25
 Volume adjustment 59
 Handset cord 17, 20
 Handset hook 18, 25
 Handset jack 20
 Handset/Headset Selection → Headset Operation 129
 Hands-free 58
 Hands-free Answerback 99
 Hang up (button) 35, 41
 Headset 17
 Bluetooth 155
 Connections 147
 Flexible button 141
 Volume adjustment 59
 Headset jack 20
 Headset Operation 100, 129
 Feature clear 131
 Hold 69

- Retrieve 69
- HOLD button 18
- HOME
 - HOME button 27
 - HOME screen 29
- Home position (Camera) 82
- Homepage 54
- Host PBX 88
- Hot Line 62, 100, 126
 - Feature clear 131
- Hurry-up (flexible button) 139

I

- ICD Group message 103
- Icons
 - Call log 48
 - Call status 41
 - Telephone status 33
- Incoming Call Distribution Group (ICD Group) (flexible button) 136
- Incoming Call Distribution Group message 103
- Incoming Call Log 47, 65
- Incoming Redirect Number 171
- Initializing the Unit 165
- International area code 123, 178
- IP Address 176
- IP Camera List 172
- IP Camera Selection Buttons 172
- IP Camera Selection Buttons Settings 117
- IP Camera Settings 116, 167
- IP Network Settings 159
- IP Port 176
- IP Port 1 176
- IP Port 2 176
- IP Port Settings 160

K

- Key Pad Tone Set 129
 - Feature clear 131
- Keyboard 60, 61
 - Chat screen 52
 - Contacts screen 34
 - Portal screen 54

L

- LAN port 22
- Language 172
 - Language Settings 115, 159, 172
 - Sub-display 126
- Last Number Redial 66, 100
- LCD (Liquid Crystal Display) 18
- LCD Brightness 171
- LCD Off Timer 171
- LCS Mode Set (After Answering) 128
 - Feature clear 131
- LCS, Live Call Screening 98, 100
- LDAP directory 32
 - Advanced search 35, 64
 - Search 35, 64
- LDAP Server
 - Server select (button) 35

- Settings 121, 167, 177
- Leading Digits to Remove 123, 178
- Leave message waiting (button) 42, 45
- Leave voice message (button) 42
- Left side view 20
- Liquid Crystal Display (LCD) 18
- Live Call Screening (LCS) 98, 100
 - Flexible button 143
- Live Call Screening Mode Set 128
 - Feature clear 131
- Local Directory 32, 172
 - Search 32, 63
- Location (drop-down list) 50
- Lock 75
- Login Code 172
- Log-in/Log-out 101
 - All groups (flexible button) 139
 - Feature clear 131
 - Flexible button 139
 - Remote setting 103
 - Specified group (flexible button) 139
- Loop-CO (L-CO) (flexible button) 135

M

- MAC Address
 - Application 177
 - VoIP 177
- Maintenance 162, 177
- Make a conference (button) 43, 44
- Making calls
 - Calling 62
 - From call log 65
 - From Chat 83
 - From the LDAP directory 64
 - From the local directory 63
 - From the Portal 84
 - One-touch Dialing 66
 - Outside call 62
- Manual Call Waiting 128
- Manual Call Waiting-Intercom Calls
 - Feature clear 131
- Manual Queue Redirection 101
- Message (flexible button) 136
- Message for Another Extension Button (flexible button) 136
- Message Lamp 18
- Message Waiting 86, 101
 - Checking 76, 101
 - Feature clear 131
- MIC (microphone) 18
- Min. number of digits of an outside line: 123, 178
- Missed Call (button) 30
- Missed Call Log 47, 65
- Missed calls 78
- Multiple Party Conversation → Conference call 73
- Mute 72
- Mute (button)
 - Calls screen 42
 - Camera screen 51

N

Name 173
 Navigator Key 18
 NDSS, Network Direct Station Selection 102
 Network camera 81
 Network Direct Station Selection (NDSS) (flexible button) 141
 Network Direct Station Selection (NDSS) Monitor 102
 Network Settings 167
 New Message (button) 30
 New Password 171

O

Off-hook Monitor 102
 OGM, Recording Out Going Message 103
 OK button 59
 One-touch Dialing 66
 Flexible button 136
 One-touch Dialing Assignment Mode Selection 130
 One-touch Two-way Transfer 106
 Flexible button 143
 Operation board
 Angle adjust button 21
 Angle adjustment 23
 Operator Call 62, 102
 Options
 Administrator 121
 User 113
 Options screen 57
 Options tab 28
 Outgoing Call Log 47, 65
 Override (Conference) 45, 87
 Override the Call (button) 45
 Override, Do Not Disturb (DND) 96
 Override, Executive Busy 97

P

Paging Deny 129
 Feature clear 131
 Paging, Group 99
 Pan scan 82
 Button 50
 Pan/Tilt control (button) 50
 Park the call (Automatic) (button) 43
 Park the call (Manual) (button) 43
 Parking zone 70
 Password 171, 172, 177
 Password Settings 113
 Paste (text) 60
 PBX Change Time 176
 PBX Feature List 89
 PBX IP Address 1 176
 PBX IP Address 2 176
 PC port 22
 PC, Connections 147
 PDN/SDN Extension 102
 Personal Absent Message 128
 Feature clear 131
 Personal Directory All Delete 166
 Personal Directory Data 167
 Personal Speed Dialing 102

Port Number 177
 Portal 84
 Home button 84
 Making calls 84
 Web page drop-down list 84
 Portal screen 54
 Portal Settings 117
 Portal tab 28
 Position (drop-down list) 50
 Pre-dialing 62
 Preferred Line Assignment—Incoming 127
 Feature clear 131
 Preferred Line Assignment—Outgoing 127
 Feature clear 131
 Presence 174
 Call Forwarding/DND 120
 Changing 78
 Custom presence 78
 Customizing presence buttons 118
 Feature number 120
 Presence message 174
 Settings 118
 Presence Data (check box) 167
 Presence drop-down list 30
 Presence List Settings 119
 Primary Directory Number (PDN) (flexible button) 142
 Primary Directory Number (PDN)/Secondary Directory Number (SDN) Extension 102
 Primary Port 177
 Printing Message 102
 Programming Input Table 134
 PT Programming 125
 PTAP Client
 IP Port 1 176
 IP Port 2 176
 PTAP Server
 IP Port 1 176
 IP Port 2 176
 Put the call on hold (button) 43

Q

QoS 161, 176
 Quick Dialing 62
 Quick-access button (Camera screen) 50

R

Record the call (button) 43
 Recording calls 72
 Recording Out Going Message (OGM) 103
 Redial 66, 100
 Button 31
 Redirect to Input No. (button) 42
 Redirect to voice mail (button) 42
 Redirecting calls 68
 Release (flexible button) 140
 Remote COS Access 103
 Remote Extension Dial Lock 103
 Remote Setting 103
 Remote Wake-up Call 100
 Remove (0) 123, 178
 Remove participant (button) 44

Restart
 Automatic 168
 Manual 168
Retrieve the Call (button) 44
Return to HOME button (Feature Key screen) 56
Right side view 19
Ringer
 Indicator 31
 Volume adjustment 58
Ringer Lamp 18

S

Scrolling 59
SD memory card 181
 Compatible 181
 Formatting 166, 182
 Inserting 181
 Removing 181
 Slot 19
 Write-protection switch 181
Search
 LDAP advanced search 35, 64
 LDAP directory 35, 64
 Local directory 32, 63
Secondary Directory Number (SDN) (flexible button) 142
Secondary Port 177
Select Calls Screen 114, 171
Selecting items 59
Send (button) 53
Send Flash (button) 44
Server Logon 177
Server Name/Address 177
Service-in 97
Service-out 97
Set call back (button) 45
Shift key 60
Side cover 19
Simplified Voice Message 76, 104
Single-CO (S-CO) (flexible button) 135
Soft button (Feature Key screen) 37, 55
Soft keyboard 60
 Chat screen 52
 Contacts screen 34
 Portal screen 54
Speaker volume 59
Specifications 170
Speed Dial 126, 172
Split call 71
Split the Call (button) 44
SP-PHONE (speakerphone) button 18
Start-up Settings 157
 Error Log 166
 Firmware Version 165
 Firmware version update 163
 IP Address 159
 IP Port 160
 Language 159
 Maintenance 162
 Quality of Service (QoS) 161
 Setting Initialize 165
Stop Recording (button) 43
Stylus pen 17, 21

Sub-display (Feature Key screen) 38, 55
Subnet Mask 176
SVM (Simplified Voice Message) 76, 104
System Alarm (flexible button) 140
System diagram 5
System reset 168
System Speed Dialing 105

T

Tabs (screens) 27
TAFAS, Trunk Answer From Any Station 106
Telephone status 33
 Icons 33
Terminate (flexible button) 138
Text
 Cut/copy/paste 60
 Selecting 60
TIE Line Access 105
Tilt scan 82
 Button 51
Tilt/Pan control (button) 50
Time Mode 103
Time Service 103
 Changing (flexible button) 140
 Switching Mode (Automatic/Manual) (flexible button) 141
Time Service Mode Control 106
Timed Reminder 106
 Feature clear 131
Timed Reminder message 103
Toll Restriction Button (flexible button) 140
Touch Screen Sound 171
Transfer 71
 to Voice Mail 71, 72
TRANSFER button 18
Transfer the Call (button) 43
Transfer to VM (button) 43
Trunk Answer From Any Station (TAFAS) 106
Two-way Record 72, 106
 Flexible button 142
Two-way Transfer 106
 Flexible button 143

U

Unpark the call (button) 46
URL 173
USB Device, Connections 149
USB keyboard 61
USB port 19
User Options 57, 113
 Call Forwarding/Do Not Disturb 120
 Dial Number Settings 114
 Directory List Select Settings 115
 Display 113
 IP Camera Selection Buttons Settings 117
 IP Camera Settings 116
 Language Settings 115
 Password 113
 Portal Settings 117
 Presence List 119
 Presence Settings 118
 Web Page List Settings 118

V

- Verify Password 171
- View
 - Back 21
 - Bottom 22
 - Front 18
 - Left side 20
 - Right Side 19
- VLAN 177, 180
- VLAN ID
 - Firmware update 180
 - Primary Port 177
 - Secondary Port 177
- VLAN Priority
 - Firmware update 180
 - Primary Port 177
 - Secondary Port 177
- Voice Mail 86
 - Accessing 77
 - Checking new messages 77
- Voice Mail Number 171
- Voice Mail Transfer 71, 72
 - Flexible button 143
- Voice Message 76, 77, 86
 - Simplified Voice Message 76, 104
- Voice Processing System (VPS) 86
- VoIP Application Version 175
- VoIP IP Address 176
- VoIP IPL Version 175
- Volume 58
 - Handset/headset/speaker 59
 - Ringer 58

W

- Wait and send call waiting (button) 45
- Walking COS 98
- Walking Extension 98
- Wall mounting 150
 - Accessories 17
- Web browser → Portal 84
- Web page drop-down list 54
- Web Page List 173
- Web Page List Settings 118
- Wrap-up 101
 - Flexible button 139
- Write-protection (LOCK) 181

Z

- Zoom (Camera) 81
- Zoom in (button) 50
- Zoom out (button) 50

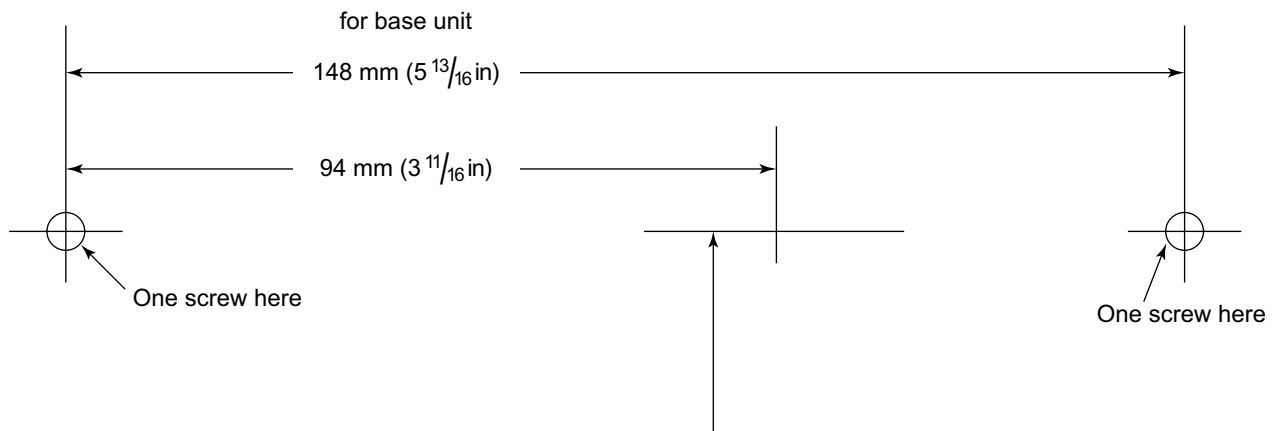

WALL MOUNTING TEMPLATE

1. Drive the screws into the wall as indicated.
2. Hook the unit onto the screw heads.

Note:

Make sure to set the print size to correspond with the size of this page. If the dimensions of the paper output still deviate slightly from the measurements indicated here, use the measurements indicated here.

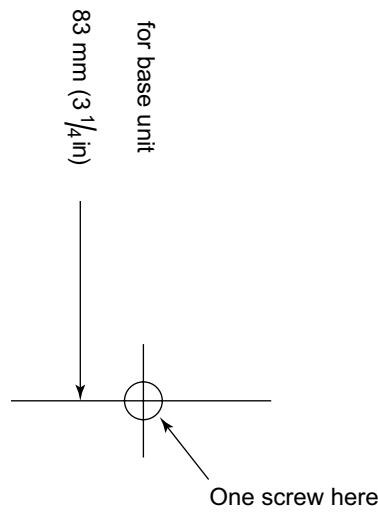

Panasonic Corporation of North America
One Panasonic Way, Secaucus, New Jersey 07094

<http://www.panasonic.com/csd>



Copyright:

This material is copyrighted by Panasonic System Networks Co., Ltd., and may be reproduced for internal use only. All other reproduction, in whole or in part, is prohibited without the written consent of Panasonic System Networks Co., Ltd.

© Panasonic System Networks Co., Ltd. 2010