



# Panasonic

## Advanced Hybrid System

## User Manual



KX-TES824  
Model KX-TEM824



Thank you for purchasing a Panasonic Advanced Hybrid System.  
Please read this manual carefully before using this product and save this manual for future use.

**KX-TES824/KX-TEM824: Version 3.0**

## Feature Highlights

### 1.5.5 Using Voice Messaging (Built-in Voice Message [BV])

**Built-in Voice Message**

You can set incoming calls to be forwarded to your personal message area to let callers leave voice messages when you cannot answer the phone.

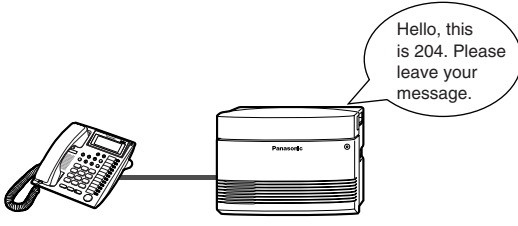

### 1.8.3 If a Voice Processing System is Connected

**Voice Mail Integration**

You can set your calls to be forwarded to a separate Voice Processing System (VPS) to let callers leave messages in your mailbox when you cannot answer the phone.

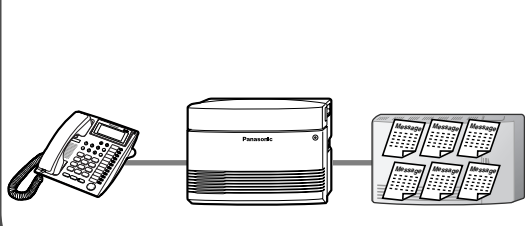

### 1.1.1 Before Operating a Telephone

**Advanced Hybrid System**

This PBX supports the connection of Panasonic proprietary telephones (PTs), Direct Station Selection (DSS) Consoles, and single line devices such as single line telephones (SLTs), fax machines, wireless telephones, and data terminals.

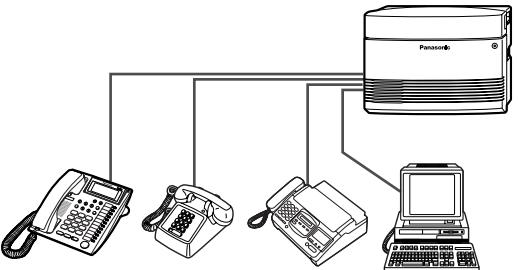

### 1.2.7 Accessing Another Party Directly from Outside (Direct Inward System Access [DISA])

**3-level Automated Attendant**

A caller can be directed to the desired party simply by pressing a single-digit number as directed by the 3-level DISA outgoing messages (OGMs).

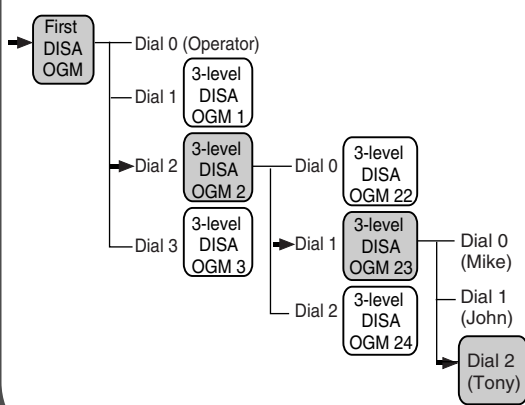

### 1.1.1 Before Operating a Telephone

#### **Easy Operation**

A Panasonic telephone that is equipped with a Navigator Key and a display helps you to access various features easily. The Message/Ringer lamp (if equipped) informs you of any calls or messages waiting.



Navigator Key



Message/Ringer Lamp

#### **Fixed Line SMS Terminal Support**

This PBX can route incoming calls sent from a Short Message Service (SMS) centre to specific single line telephones (SLTs) that support SMS.

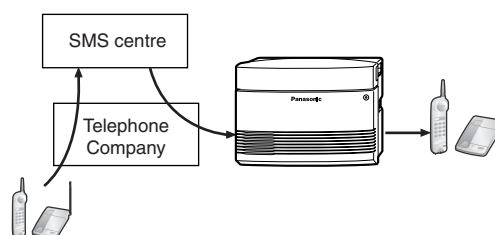

We recommend using SMS-enabled Panasonic SLTs.

#### **In this manual,**

- Proprietary Telephone is abbreviated as "PT"<sup>\*1</sup>.  
Single Line Telephone is abbreviated as "SLT".  
Proprietary Telephone with a Display is abbreviated as "Display PT".
- The suffix of each model number is omitted.
- The following icons are used as hints and conditions throughout this manual.



Hints



Conditions

### **Important Notice**

Prior to connection of this product, please verify that the intended operating environment is supported. Satisfactory performance cannot be guaranteed for the following:

- interoperability and compatibility with all devices and systems connected to this product
- proper operation and compatibility with services provided by telecommunications companies over connected networks

<sup>\*1</sup> In this manual, "proprietary telephone" ("PT") means an analogue proprietary telephone (APT).

---

# Important Information

## **WARNING**

- THIS UNIT MAY ONLY BE INSTALLED AND SERVICED BY QUALIFIED SERVICE PERSONNEL.
- IF DAMAGE TO THE UNIT EXPOSES ANY INTERNAL PARTS, DISCONNECT THE POWER SUPPLY CORD IMMEDIATELY AND RETURN THE UNIT TO YOUR DEALER.
- UNPLUG THIS UNIT FROM THE AC OUTLET IF IT EMITS SMOKE, AN ABNORMAL SMELL OR MAKES UNUSUAL NOISE. THESE CONDITIONS CAN CAUSE FIRE OR ELECTRIC SHOCK. CONFIRM THAT SMOKE HAS STOPPED AND CONTACT AN AUTHORISED PANASONIC FACTORY SERVICE CENTRE.
- WHEN RELOCATING THE EQUIPMENT, FIRST DISCONNECT THE TELECOM CONNECTION BEFORE DISCONNECTING THE POWER CONNECTION. WHEN THE UNIT IS INSTALLED IN THE NEW LOCATION, RECONNECT THE POWER FIRST, AND THEN RECONNECT THE TELECOM CONNECTION.
- THIS UNIT IS EQUIPPED WITH AN EARTHED PLUG. FOR SAFETY REASONS THIS PLUG MUST ONLY BE CONNECTED TO AN EARTHED OUTLET THAT HAS BEEN INSTALLED ACCORDING TO APPLICABLE REGULATIONS.
- TO PREVENT POSSIBLE FIRE OR ELECTRIC SHOCK, DO NOT EXPOSE THIS PRODUCT TO RAIN OR MOISTURE.
- THE POWER SUPPLY CORD IS USED AS THE MAIN DISCONNECT DEVICE. ENSURE THAT THE AC OUTLET IS LOCATED NEAR THE EQUIPMENT AND IS EASILY ACCESSIBLE.
- TO PROTECT THIS UNIT FROM STATIC ELECTRICITY, DO NOT TOUCH ANY EXTERNAL CONNECTORS OF THE UNIT.

## **Safety Instructions**

When using your telephone equipment, basic safety precautions should always be followed to reduce the risk of fire, electric shock and injury to persons, including the following:

1. Do not use this product near water, for example, near a bathtub, wash bowl, kitchen sink, or laundry tub, in a wet basement, or near a swimming pool.
2. Avoid using wired telephones during an electrical storm. There is a remote risk of electric shock from lightning.
3. Do not use a telephone in the vicinity of a gas leak to report the leak.
4. Use only the power cord and batteries indicated in this manual. Do not dispose of batteries in a fire, as they may explode. Dispose according to local regulations.

**SAVE THESE INSTRUCTIONS**



The KX-TES824E, the KX-TES824NE, the KX-TES824GR, the KX-TES824CE/  
KX-TEM824CE, and the KX-TES824PD/KX-TEM824PD are designed to  
interwork with the Analogue Public Switched Telephone Network (PSTN) of  
European countries.

Panasonic Communications Co., Ltd./Panasonic Communications Company (U.K.) Ltd. declares that  
this equipment is in compliance with the essential requirements and other relevant provisions of Radio  
& Telecommunications Terminal Equipment (R&TTE) Directive 1999/5/EC.  
Declarations of Conformity for the relevant Panasonic products described in this manual are available  
for download by visiting:

**<http://www.doc.panasonic.de>**

Contact:  
Panasonic Services Europe  
a Division of Panasonic Marketing Europe GmbH  
Panasonic Testing Centre  
Winsbergring 15, 22525 Hamburg, Germany

---

## ***Attention***

- Keep the unit away from heating appliances and devices that generate electrical noise such as fluorescent lamps, motors, and televisions. These noise sources can interfere with the performance of the PBX.
- This unit should be kept free of dust, moisture, high temperature (more than 40 °C ), and vibration, and should not be exposed to direct sunlight.
- If you are having problems making calls to outside destinations, follow this procedure to test the outside (CO) lines:
  1. Disconnect the PBX from all outside (CO) lines.
  2. Connect known working single line telephones (SLTs) to those outside (CO) lines.
  3. Make a call to an external destination using those SLTs.

If a call cannot be carried out correctly, there may be a problem with the outside (CO) line that the SLT is connected to. Contact your telephone company.

If all SLTs operate properly, there may be a problem with your PBX. Do not reconnect the PBX to the outside (CO) lines until it has been serviced by an authorised Panasonic Factory Service Centre.

- Never attempt to insert wires, pins, etc. into the vents or holes of this unit.
- Wipe the unit with a soft cloth. Do not clean the unit with abrasive powders or with chemical agents such as benzene or thinner.
- When using a Panasonic proprietary telephone (PT), use only the correct Panasonic handset.

---

### Information on Disposal for Users of Waste Electrical & Electronic Equipment (private households)

- This symbol on the products and/or accompanying documents means that used electrical and electronic products should not be mixed with general household waste. For proper treatment, recovery and recycling, please take these products to designated collection points, where they will be accepted on a free of charge basis. Alternatively, in some countries you may be able to return your products to your local retailer upon the purchase of an equivalent new product. Disposing of this product correctly will help to save valuable resources and prevent any potential negative effects on human health and the environment which could otherwise arise from inappropriate waste handling. Please contact your local authority for further details of your nearest designated collection point. Penalties may be applicable for incorrect disposal of this waste, in accordance with national legislation.

#### For business users in the European Union

- If you wish to discard electrical and electronic equipment, please contact your dealer or supplier for further information.

#### Information on Disposal in other Countries outside the European Union

- This symbol is only valid in the European Union. If you wish to discard this product, please contact your local authorities or dealer and ask for the correct method of disposal.



#### For users in New Zealand only

- This equipment shall not be set to make automatic calls to the Telecom '111' Emergency Service.
- The grant of a Telepermit for any item of terminal equipment indicates only that Telecom has accepted that the item complies with minimum conditions for connection to its network. It indicates no endorsement of the product by Telecom, nor does it provide any sort of warranty. Above all, it provides no assurance that any item will work correctly in all respects with another item of Telepermitted equipment of a different make or model, nor does it imply that any product is compatible with all of Telecom's network services.
- **IMPORTANT NOTICE**  
Under power failure conditions, the connected telephones may not operate. Please ensure that a separate telephone, not dependent on local power, is available for emergency use.
- **APPLICABLE ONLY TO TELECOM CUSTOMERS WHO HAVE AUTOMATIC ACCESS TO OTHER CARRIERS FOR TOLL CALLS**  
When calling back a number from the Caller ID list, all numbers prefixed with "0 + AREA CODE" will be automatically forwarded to your toll carrier. This includes numbers in your local calling area. The zero + area code should either be removed when calling back local numbers, or check with your toll carrier that a charge will not be levied.
- All persons using this device for recording telephone conversations shall comply with New Zealand law. This requires that at least one party to the conversation is to be aware that it is being recorded. In addition, the principles enumerated in the Privacy Act 1993 shall be complied with in respect to the nature of the personal information collected, the purpose for its collection, how it is used, and what is disclosed to any other party.

---

## For Future Reference

Please print, record, and retain the following information for future reference.

### **Note**

The serial number of this product can be found on the label affixed to the unit. You should record the model number and the serial number of this unit as a permanent record of your purchase to aid in identification in the event of theft.

MODEL NO.	_____
SERIAL NO.	_____
DATE OF PURCHASE	_____
NAME OF DEALER	_____
DEALER'S ADDRESS	_____ _____ _____ _____
DEALER'S TEL. NO.	_____



---

# Table of Contents

<b>1</b>	<b>Operation</b>	<b>11</b>
1.1	<b>Before Operating a Telephone</b>	<b>12</b>
1.1.1	Before Operating a Telephone	12
1.2	<b>Making Calls</b>	<b>20</b>
1.2.1	Basic Calling	20
1.2.2	Easy Dialling	25
1.2.3	Redialling	29
1.2.4	When the Dialed Party is Busy or There is No Answer	31
1.2.5	Switching the Calling Method (Alternate Calling—Ring/Voice)	39
1.2.6	Using Your Calling Privileges at Another Extension (Walking COS)	40
1.2.7	Accessing Another Party Directly from Outside (Direct Inward System Access [DISA])	41
1.3	<b>Receiving Calls</b>	<b>44</b>
1.3.1	Answering Calls	44
1.3.2	Answering Hands-free (Hands-free Answerback)	45
1.3.3	Answering a Call Ringing at Another Telephone (Call Pickup)	46
1.4	<b>During a Conversation</b>	<b>48</b>
1.4.1	Transferring a Call (Call Transfer)	48
1.4.2	Holding a Call	50
1.4.3	Talking to 2 Parties Alternately (Call Splitting)	54
1.4.4	Answering Call Waiting	55
1.4.5	Talking to Multiple Parties (Conference)	58
1.4.6	Muting a Microphone (Microphone Mute)	63
1.4.7	Using the Headset (Headset Operation)	64
1.4.8	Talking to Another Party without Lifting the Handset (Hands-free Operation)	65
1.4.9	Changing the Dialling Mode (Pulse to Tone Conversion)	66
1.5	<b>Before Leaving Your Desk</b>	<b>67</b>
1.5.1	Forwarding Your Calls (Call Forwarding [FWD])	67
1.5.2	Showing a Message on the Caller's Telephone Display (Absent Message)	70
1.5.3	Preventing Other People from Using Your Telephone (Extension Lock)	72
1.5.4	Leaving a Group (Log-in/Log-out)	73
1.5.5	Using Voice Messaging (Built-in Voice Message [BV])	74
1.6	<b>Making/Answering a Paging Announcement</b>	<b>83</b>
1.6.1	Paging	83
1.6.2	Answering/Denying a Paging Announcement	85
1.7	<b>Setting the Telephone According to Your Needs</b>	<b>86</b>
1.7.1	Setting the Alarm (Timed Reminder)	86
1.7.2	Refusing Incoming Calls (Do Not Disturb [DND])	88
1.7.3	Receiving Call Waiting	89
1.7.4	Preventing Other People from Joining Your Conversation (Executive Busy Override Deny)	90
1.7.5	Turning on the Background Music (BGM)	91
1.7.6	Protecting Your Line against Notification Tones (Data Line Security)	92
1.7.7	Checking the Time Service Mode	93
1.7.8	Clearing Features Set at Your Extension (Extension Feature Clear)	94
1.7.9	Monitoring a Room (Room Monitor)	95
1.8	<b>Using User-supplied Equipment</b>	<b>97</b>
1.8.1	If a Doorphone/Door Opener is Connected	97
1.8.2	If a Host PBX is Connected	99

1.8.3	If a Voice Processing System is Connected.....	100
<b>1.9</b>	<b>Using a Display Proprietary Telephone .....</b>	<b>107</b>
1.9.1	Calling with the Incoming Call Log.....	107
<b>2</b>	<b>Operator/Manager Operation.....</b>	<b>113</b>
<b>2.1</b>	<b>Control Features .....</b>	<b>114</b>
2.1.1	Locking Other Extensions (Remote Extension Lock).....	114
2.1.2	Switching the Time Service Mode (Time Service).....	115
2.1.3	Setting an Alarm for Other Extensions (Remote Timed Reminder [Wake-up Call]) .....	117
2.1.4	Erasing All Caller Information in the Common Area (Incoming Call Log in the Common Area—CLEAR ALL) .....	119
2.1.5	Disregarding the Newest Call or Overwriting the Oldest Call in the Common Area Call Log (301st Incoming Call Logged in the Common Area) .....	120
2.1.6	Recording, Playing, or Erasing Common BV Outgoing Messages .....	121
2.1.7	Changing System Settings Using Programming Mode .....	123
<b>3</b>	<b>Customising Your Phone &amp; PBX .....</b>	<b>127</b>
<b>3.1</b>	<b>Customising Your Phone (Personal Programming).....</b>	<b>128</b>
3.1.1	Customising Your Phone (Personal Programming).....	128
3.1.2	Changing Personal Settings Using Programming Mode.....	129
3.1.3	Customising the Buttons .....	132
<b>3.2</b>	<b>Managing Call Logs and Call Charges.....</b>	<b>135</b>
3.2.1	Requirements.....	135
3.2.2	Managing Call Logs and Call Charges.....	136
<b>3.3</b>	<b>Customising Your PBX (System Programming).....</b>	<b>138</b>
3.3.1	Programming Information.....	138
3.3.2	System Programming.....	141
<b>4</b>	<b>Appendix .....</b>	<b>145</b>
<b>4.1</b>	<b>Troubleshooting .....</b>	<b>146</b>
4.1.1	Troubleshooting.....	146
<b>4.2</b>	<b>Feature Number Table .....</b>	<b>150</b>
4.2.1	Feature Number Table.....	150
<b>4.3</b>	<b>Identifying Tones.....</b>	<b>158</b>
4.3.1	Identifying Tones .....	158
<b>4.4</b>	<b>Revision History .....</b>	<b>166</b>
4.4.1	Version 2.0 .....	166
<b>Index .....</b>	<b>167</b>	

---

# **Section 1**

## **Operation**

*This chapter shows you step by step how to use each feature.  
Read this chapter to become familiar with the many useful  
features of this PBX.*

# 1.1 Before Operating a Telephone

## 1.1.1 Before Operating a Telephone

### ◆◆ What Kind of Telephone Can Be Used?

You can use a single line device such as a single line telephone (SLT), fax machine, modem, or wireless telephone, or a Panasonic proprietary telephone (PT) such as the KX-T7730. Some features may not be available, depending on the telephone you are using.

If you are using a Panasonic PT with special feature buttons, or a display (Display PT), or both, follow the procedures that use feature buttons or the display, for easy operation.

If you are using an SLT, follow the procedures that use specified numbers to access features (feature numbers).

If you use a Direct Station Selection (DSS) Console, you can also use the buttons on the DSS Console to perform operations, instead of the buttons on the connected PT.

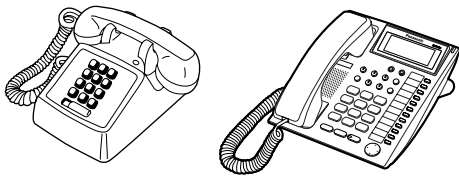

- If you use a Panasonic PT that does not have feature buttons, you may change one of the unused flexible buttons to a feature button. Refer to "3.1.3 Customising the Buttons".

### ◆◆ Feature Numbers

Features have been assigned feature numbers, which can be entered on your telephone to access the corresponding feature. Some features are only accessible by entering the feature number. In addition, some features require other additional parameters to be entered to activate the feature. Where necessary, these are specified in the text.

#### **Notice**

The default value assigned to certain features may vary depending on your country/area. For more details, consult your dealer.



**If you use an SLT that does not have the "\*" or "#" keys,**  
it is not possible to access features that have "\*" or "#" in their feature numbers.

### ◆◆ Tone

Various tones are used during or after operations to provide you with information. For more details regarding the types of tones and their meanings, refer to "4.3.1 Identifying Tones" (Appendix).

### ◆◆ Display

In this manual, you will see the phrase "the display ...". This refers to the display of a Panasonic PT. When you use a Panasonic display PT, displayed messages or items help you to operate the telephone.

### Your Extension Number

If you use a Panasonic display PT, you can confirm your own extension number by pressing the "\*" key 2 times ("\*\*") while on-hook, or by accessing personal programming. For more details, refer to "3.1.2 Changing Personal Settings Using Programming Mode".

### ◆◆ Using a Navigator Key/Volume Key (depending on the type of your PT)

The Navigator Key can be used to control display contrast and volume, or to search for items using the display. Pressing the Navigator Key in the desired direction will change the contrast, volume level or items displayed, as shown below. On PTs with a Volume Key, this key can be used to adjust the volume, as shown below.

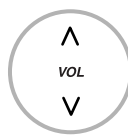
Navigator Key	Volume Key
<p><b>Up</b> (Level <b>increases</b>)</p>  <p><b>Down</b> (Level <b>decreases</b>)</p> <p><b>Left</b>   <b>Right</b></p>	<p><b>Up</b> (Level <b>increases</b>)</p>  <p><b>Down</b> (Level <b>decreases</b>)</p>

### ◆◆ Examples



The displays and the illustrations shown throughout this manual as examples are of a telephone connected to the KX-TES824/KX-TEM824.

### ◆◆ Restrictions





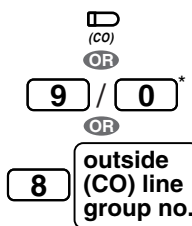

Features that have been restricted through system programming will not be available at your extension.

### ◆◆ Icon Descriptions

The following icons are used frequently throughout this manual.

 <b>No SLT</b>	This feature cannot be used with an SLT.		Seize an outside (CO) line by doing one of the following: <ul style="list-style-type: none"> <li>• Press a CO button.</li> <li>• Dial the automatic line access number (9/0)*.</li> </ul> <p><b>Note</b> * For New Zealand, the automatic line access number may be either 1 or 9. <ul style="list-style-type: none"> <li>• Dial the outside (CO) line group access number (8) and outside (CO) line group number.</li> </ul> </p>
	See "Programming" for related programming, if necessary.		









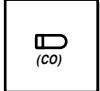
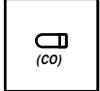

## 1.1 Before Operating a Telephone

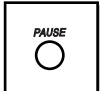
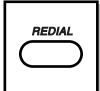
	<p>Go off-hook by doing any of the following:</p> <ul style="list-style-type: none"> <li>• Lift the handset.</li> <li>• Press the SP-PHONE button.</li> <li>• Press the MONITOR button. (To start talking, lift the handset.)</li> </ul>		<p>Press the Call button on the Doorphone.</p>
	<p>Go on-hook by doing any of the following:</p> <ul style="list-style-type: none"> <li>• Hang up.</li> <li>• Press the SP-PHONE button.</li> <li>• Press the MONITOR button.</li> </ul>		<p>Press the Recall/hookswitch briefly.</p>
	<p>Talk.</p>	<p><b>desired no.</b></p>	<p>Enter the required number. &lt;Example&gt; <b>account code</b> Enter the account code.</p>
	<p>You will hear a busy, confirmation, dial, or ringback tone.</p> <p>B. Tone: Busy Tone C. Tone: Confirmation Tone D. Tone: Dial Tone R. B. Tone: Ringback Tone</p>	<p><b>extension no.</b></p>	<p>Dial an extension number.</p>
<p><b>outside phone no.</b></p>	<p>Dial an outside telephone number.</p>	<p><b>phone no.</b></p>	<p>Dial an extension number or outside telephone number.</p>





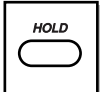

## ◆◆ When You Use a Panasonic Proprietary Telephone

If you use a Panasonic PT or DSS Console, you will be able to use some of the useful feature buttons described below. These buttons simplify certain operations. The illustrations below may differ from the actual buttons on your telephone.

### Fixed Buttons

 	<p><b>CO:</b> Used to access an outside (CO) line (or outside (CO) line group) when making or receiving a call. The button's preprogrammed Outside (CO) Line Access method determines which line is selected. Can also be customised as a feature button.</p>		<p><b>SP-PHONE:</b> Used to select handset or hands-free operation.</p>
	<p><b>AUTO DIAL/STORE:</b> Used for System Speed Dialling/Saved Number Redial, playing back personal/common BV outgoing messages (OGMs) used by the Built-in Voice Message (BV) feature, and storing programme changes.</p>		<p><b>PAUSE:</b> Used to insert a dialling pause in a stored number.</p>
	<p><b>REDIAL:</b> Used to redial the last number dialled.</p>		<p><b>MESSAGE:</b> Used to leave a message waiting indication, call back the party who left a message waiting indication, or play back voice messages. This button is provided with an LED (Light Emitting Diode), except for on KX-T7700 series telephones. With KX-T7700 series telephones, the Message/Ringer Lamp is lit when a message waiting indication is left at your extension.</p>
	<p><b>INTERCOM:</b> Used to make or receive intercom calls.</p>		<p><b>MONITOR:</b> Used to select hands-free dialling and monitor operation.</p>
	<p><b>AUTO ANS (Auto Answer)/MUTE:</b> Used to answer an intercom call automatically in hands-free mode or to mute the built-in microphone during a conversation.</p>		<p><b>TRANSFER:</b> Used to transfer a call to another party.</p>
	<p><b>HOLD:</b> Used to place a call on hold.</p>		<p><b>FLASH/RECALL:</b> Used to disconnect the current call and make another call without hanging up, or to send an EFA (External Feature Access) signal to the telephone company or host PBX to access external features.</p>

## 1.1 Before Operating a Telephone

	<b>CONF (Conference):</b> Used to establish a 3-party or 5-party conference call.		<b>VOICE CALL:</b> Used to answer an intercom call automatically.
	<b>FWD/DND (Call Forwarding/Do Not Disturb):</b> Used to set the FWD or DND feature for the extension.		<b>PROGRAM:</b> Used to enter and exit programming mode.
	<b>Navigator Key:</b> Used to adjust the volume of the speaker, handset and headset, and the display contrast, or to select desired items.		<b>Programmable Feature (PF):</b> <i>Located in the right column of the CO button array on certain telephones or on the DSS Console. Used to access a preprogrammed feature. Mostly used as a One-touch Dialling button.</i>
	<b>Volume Key:</b> Used to adjust the volume of the speaker, handset and headset.		

### Customised Buttons

Throughout this manual, when the name of a button is written in parentheses, such as "(G-CO)", this means that it is a flexible button that has been customised. To customise flexible buttons, refer to "3.1.3 Customising the Buttons".

Customised Button	Function
Single-CO (S-CO)	Used to access a specified outside (CO) line for making or receiving calls.
Group-CO (G-CO)	Used to access an idle outside (CO) line in a specified outside (CO) line group for making calls. Incoming calls from outside (CO) lines in the assigned outside (CO) line group arrive at this button.
Other-CO (O-CO)	Used to access an idle outside (CO) line for making calls. Incoming calls from the assigned outside (CO) lines, which are not assigned to S-CO or G-CO buttons, arrive at this button.
Direct Station Selection (DSS)	Used to call an extension with a one-touch operation.
One-touch Dialling	Used to call a preprogrammed party or access a feature with a one-touch operation.
Message	Used to leave a message waiting indication, call back the party who left the message waiting indication, or play back voice messages.
Message for Another Extension	Used to access messages (except Built-in Voice Message [BV] messages) left for another extension or voice messages stored in another extension's Voice Processing System (VPS) mailbox.
FWD/DND (Call Forwarding/Do Not Disturb)	Used to set the FWD or DND feature for the extension.
Save	Used to store a telephone number while in a conversation with an outside party or while hearing a busy tone, and then easily redial the number later.
Conference	Used to establish a 3-party or 5-party conference call.



<b>Customised Button</b>	<b>Function</b>
Log-in/Log-out	Used to switch between Log-in and Log-out status.
Extension Lock	Used to remotely lock or unlock another extension.
Day	Used to change the time service mode to day mode.
Night	Used to change the time service mode to night mode.
Lunch	Used to change the time service mode to lunch mode.
Caller ID Indication—Common	Used to inform you of calls logged in the common area, store the information of an incoming call during a conversation, and view caller information while on-hook and then call back a caller.
Caller ID Indication—Personal	Used to inform you of calls logged in your personal area, store the information of an incoming call during a conversation, and view caller information while on-hook and then call back a caller.
Caller ID Selection—Common	Used to display and cycle through the information of an incoming call during a conversation, while receiving a call, or while viewing caller information, display the number of logged calls while on-hook, and inform you that the common area call log is full.
Caller ID Selection—Personal	Used to display and cycle through the information of an incoming call during a conversation, while receiving a call, or while viewing caller information, display the number of logged calls while on-hook, and inform you that the personal area call log is full.
2-way Record	Used to record a conversation into your own mailbox.
2-way Transfer	Used to record a conversation into the mailbox of a specified extension.
Live Call Screening (LCS)	Used to listen while a caller is leaving a message in your voice mailbox and, if desired, intercept the call.
LCS Cancel	Used to stop monitoring your own voice mailbox while a caller is leaving a message, or stop the alert tone heard in Private mode while a caller is leaving a message.
Voice Mail (VM) Transfer	Used to transfer a call to the mailbox of a specified extension.

## ◆◆ How to Follow the Steps

An example system operation procedure is shown below.

### ◆◆ Calling Other Extensions

**Feature title**

To call another extension (Intercom Call)

**PT/SLT**

Off-hook. → (DSS extension no.) → Talk.

Press **DSS** or dial **extension number**.

**Operation steps**  
Icons and meanings are explained in "Icon Descriptions".

**Conditions**

- The Direct Station Selection (DSS) button light shows the current status as follows:  
**Off:** The extension is idle.  
**Red on:** The extension is on a call.

**Hints**

- **For quick operation**  
If you are the operator or dial certain extension numbers frequently, DSS buttons are useful.
- **Hands-free Operation**  
You can make an intercom call and have a conversation in hands-free mode using the SP-PHONE/INTERCOM button. Refer to "1.4.8 Talking to Another Party without Lifting the Handset (Hands-free Operation)".

**Customising Your Phone**

- 3.1.3 Customising the Buttons  
Create or edit a Direct Station Selection (DSS) button.

**Programming References:** Related or required programming is noted.

- **!!** If your telephone type is not included in the operation steps, for example, only "PT" is marked and you are using an SLT, your telephone cannot execute that feature.
- If your telephone can use several methods to execute one feature, you can select the preferred method according to your needs.

## ◆◆ Connection Example

This diagram shows devices that can be connected.

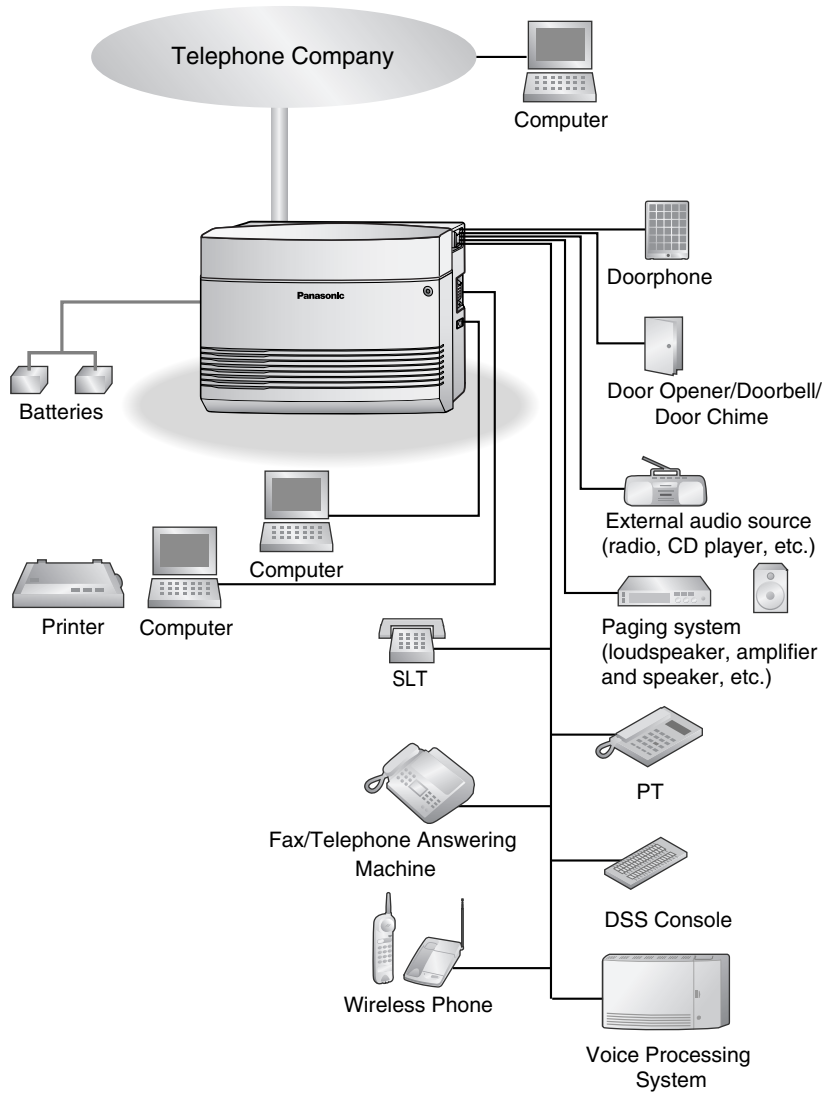

# 1.2 Making Calls

## 1.2.1 Basic Calling

- Calling Other Extensions
- Calling an Outside Party
- Using an Account Code (Account Code Entry)

### ◆◆ Calling Other Extensions

To call another extension (Intercom Call)

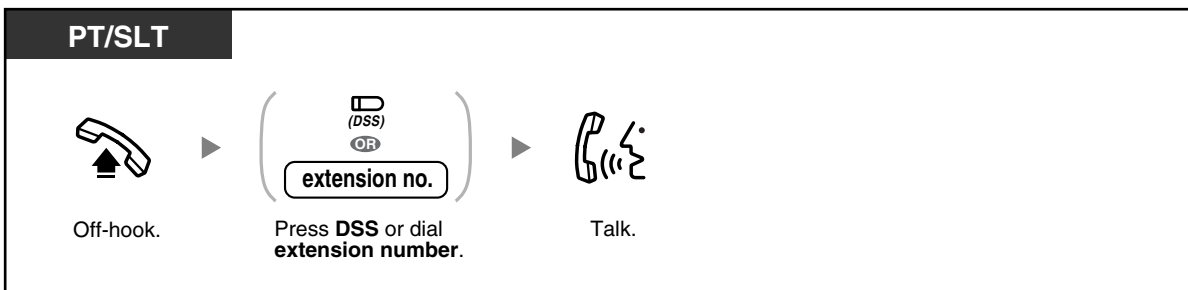

- The Direct Station Selection (DSS) button light shows the current status as follows:  
**Off:** The extension is idle.  
**Red on:** The extension is on a call.



- **For quick operation**  
If you are the operator or dial certain extension numbers frequently, DSS buttons are useful.
- **Hands-free Operation**  
You can make an intercom call and have a conversation in hands-free mode using the SP-PHONE/INTERCOM button. Refer to "1.4.8 Talking to Another Party without Lifting the Handset (Hands-free Operation)".



#### Customising Your Phone

- 3.1.3 Customising the Buttons  
Create or edit a Direct Station Selection (DSS) button.

### To call the operator (Operator Call)

You can easily call the extension assigned as the operator extension.

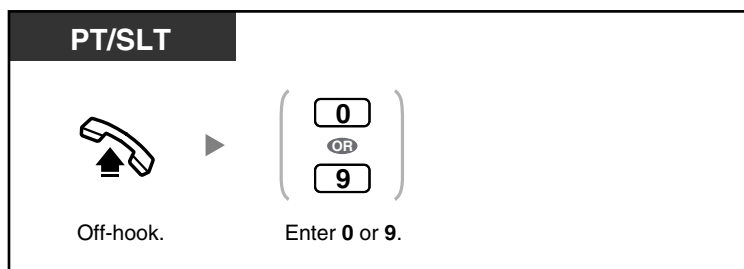

- The default operator call number varies depending on your country/area. For more details, consult your dealer.

### ◆◆ Calling an Outside Party

There are 4 methods of seizing an outside (CO) line. Use whichever method you prefer, unless requested by your manager to use a specific method.

Choose one of the following methods:

#### To select an idle outside (CO) line automatically (Automatic Line Access)

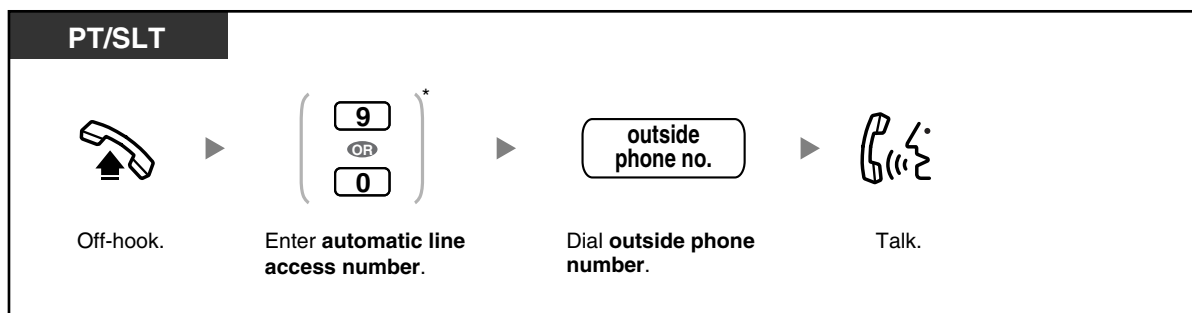

\* For New Zealand: 1 or 9



- The default automatic line access number varies depending on your country/area. For more details, consult your dealer.

**To select an idle outside (CO) line in the specified outside (CO) line group automatically (Outside (CO) Line Group Access)**

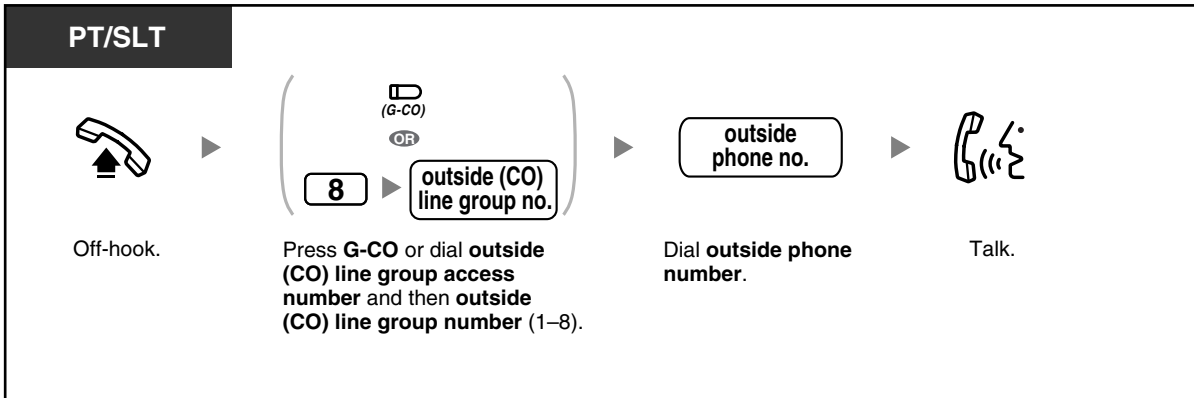

**To select a specified outside (CO) line**

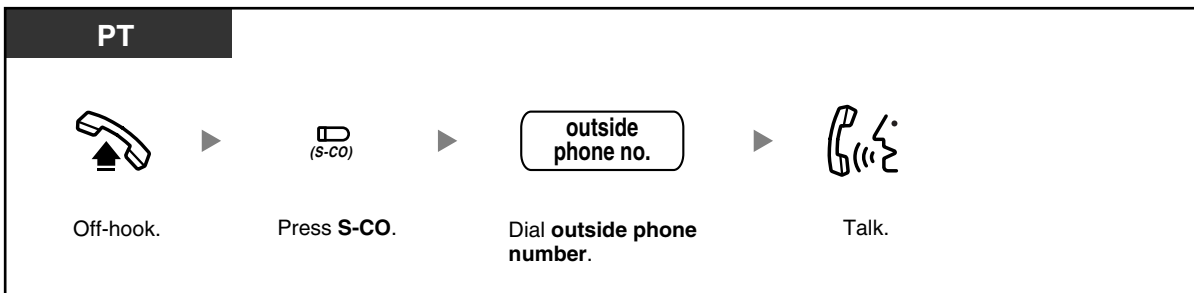

**To select an idle unassigned outside (CO) line**

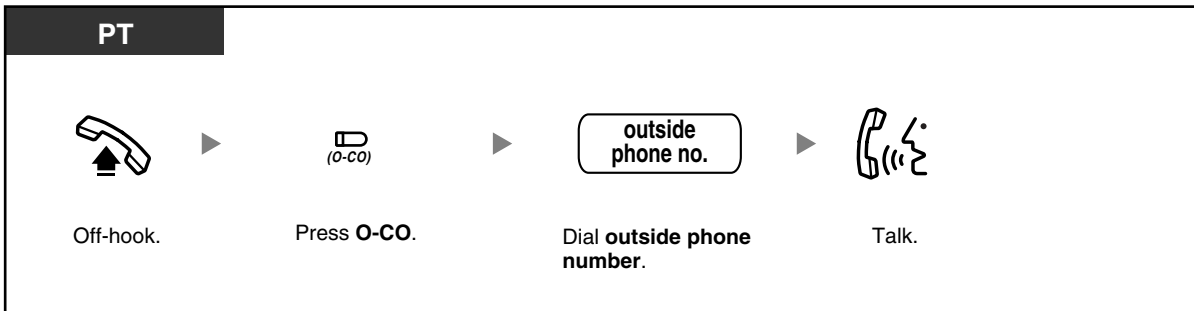



- The Single-CO (S-CO) and Group-CO (G-CO) button lights show the current status as follows:
  - Off:** The line is idle.
  - Green on:** You are using the line.
  - Red on:** Another extension is using the line (S-CO), or other extensions are using all outside (CO) lines in the outside (CO) line group (G-CO).
- **Emergency Call**  
You can dial preprogrammed emergency numbers after seizing an outside (CO) line without any restrictions.
- You can press the S-CO or G-CO button without going off-hook first.
- You may be restricted from making calls to certain outside parties. If you have questions about your calling restrictions, consult your manager or dealer.
- If you use a Panasonic display proprietary telephone (PT), the call charge (if enabled), system speed dialling name (if stored, on a System Speed Dialling call), and call duration can be displayed alternately by pressing the CO button whose indicator is green.
- **Extension-to-Outside (CO) Line Call Duration**  
The length of extension-to-outside (CO) line calls may be limited through system programming. Both the extension user and the outside party will hear a warning tone at 5-second intervals 15 seconds before a specified time limit. When the timer expires, the call is disconnected.
- **Budget Limitation**  
The length of outside (CO) line calls may be limited due to Budget Limitation through system programming. Both the extension user and the outside destination will hear an alarm (3 sets of 3 beeps) when a specified limit is reached and the extension user cannot make further outside (CO) line calls. If programmed through system programming, the call may be disconnected after the alarm.



- **To make a call to another party without going on-hook**, press the FLASH/RECALL button. Pressing the button will re-access the outside (CO) line and provide an external dial tone. You can dial the new phone number without going on/off-hook.
- **Hands-free Operation**  
You can make an outside (CO) line call and have a conversation in hands-free mode using the SP-PHONE button. Refer to "1.4.8 Talking to Another Party without Lifting the Handset (Hands-free Operation)".



### Customising Your Phone

- 3.1.2 Changing Personal Settings Using Programming Mode—**Line Preference—Outgoing**  
Select the seized line when going off-hook.
- 3.1.3 Customising the Buttons  
Create or edit a Single-CO (S-CO) button, Group-CO (G-CO) button, or Other-CO (O-CO) button.

## ◆◆ Using an Account Code (Account Code Entry)

The manager may give personal account codes to extension users, and check their telephone usage for accounting purposes. Alternatively, an account code can be specified for each customer, to log call durations for billing purposes.

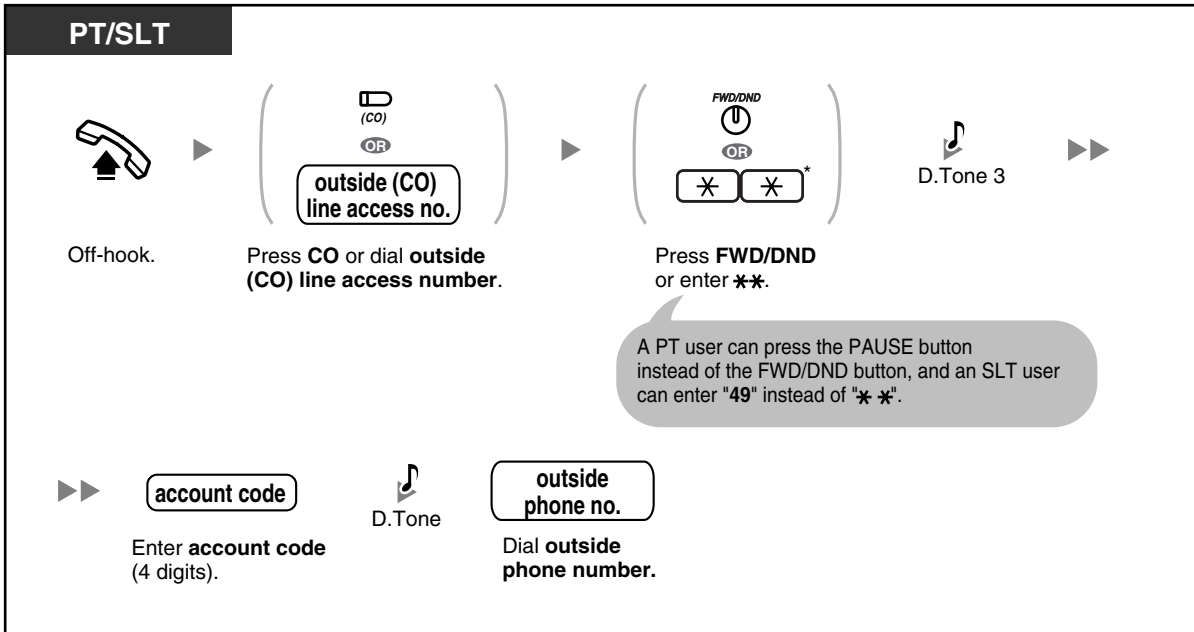

- \* Enter "\* \*" when "Plan 2" or "Plan 3" is selected as the numbering plan through system programming.
- You may not be able to make an outside (CO) line call without entering an account code depending on your telephone's mode of account code entry. The mode is assigned to each extension. Ask your manager or dealer about your telephone's mode.
- **A Panasonic PT user** can enter an account code during a conversation or within 30 seconds after the other party hangs up (while hearing a reorder tone), by pressing the FWD/DND (Call Forwarding/Do Not Disturb) button, then entering the account code.
- Account codes may use the digits "0 through 9". Non-numeric codes such as FLASH/RECALL and PAUSE cannot be used.
- You can clear the account code by pressing the "\* \*" key or FWD/DND button while entering the account code, and then re-enter the account code.



- **If you hear a reorder tone after entering the account code**, the account code entered does not exist. Enter the correct code.
- **For your convenience**, you can store a code together with a phone number in the telephone's memory (e.g., Speed Dialling).



### Customising Your Phone

- 3.1.3 Customising the Buttons  
Create or edit an FWD/DND (Call Forwarding/Do Not Disturb).



## 1.2.2 Easy Dialling

There are several convenient methods of storing and dialling frequently used phone numbers.

- Using a One-touch Button (One-touch Dialling)
- Using Numbers Stored at Your Extension (Personal Speed Dialling)
- Using Numbers Stored in the PBX (System Speed Dialling)
- Dialling a Preset Number by Going Off-hook (Hot Line)
- Using a Preprogrammed Number (Quick Dialling)

### ◆◆ Using a One-touch Button (One-touch Dialling)

You can dial a phone number (max. 24 digits) previously stored to a flexible button with a one-touch operation.



No SLT

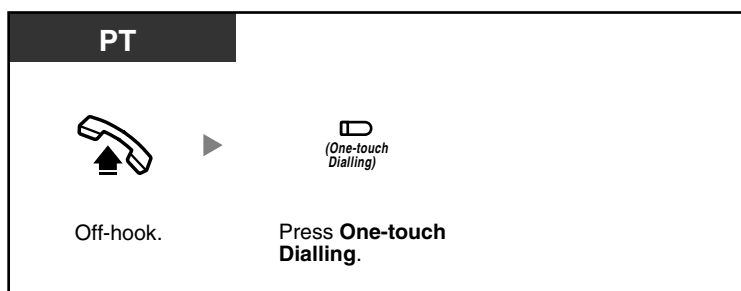

- A telephone number longer than 24 digits can be stored by dividing it among 2 or more One-touch Dialling buttons.
- You can confirm the stored number of a One-touch Dialling button by pressing it while on-hook.
- You can press a CO button to select a desired outside (CO) line before pressing the One-touch Dialling button.



#### Customising Your Phone

- 3.1.3 Customising the Buttons  
Create or edit a One-touch Dialling button, store the desired phone number, or feature number.

## ◆◆ Using Numbers Stored at Your Extension (Personal Speed Dialling)

You can store up to 10 numbers at your extension for your personal use. This feature is also known as Station Speed Dialling.

### To store a phone number

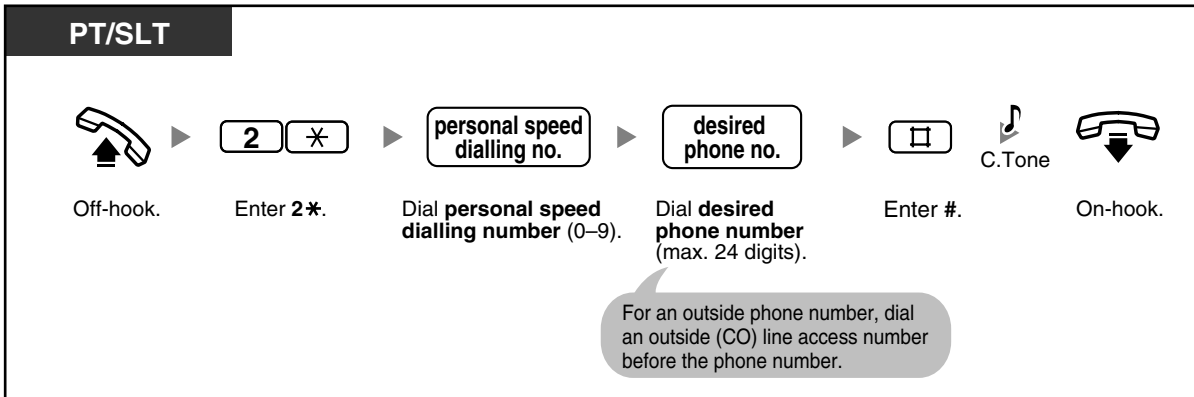

### To dial

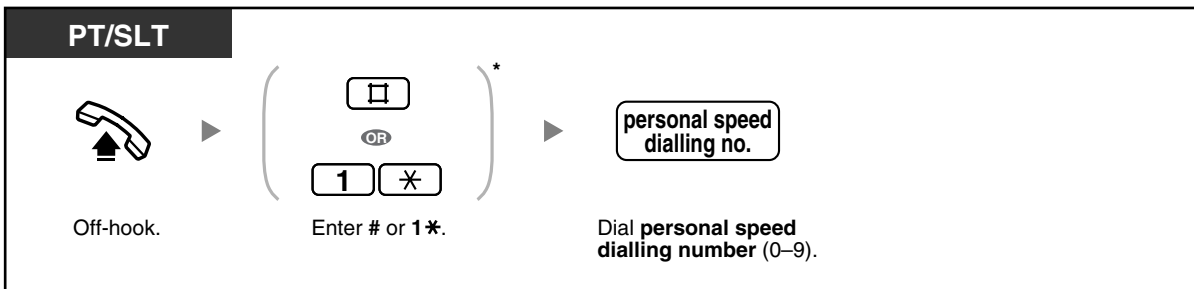

### To confirm

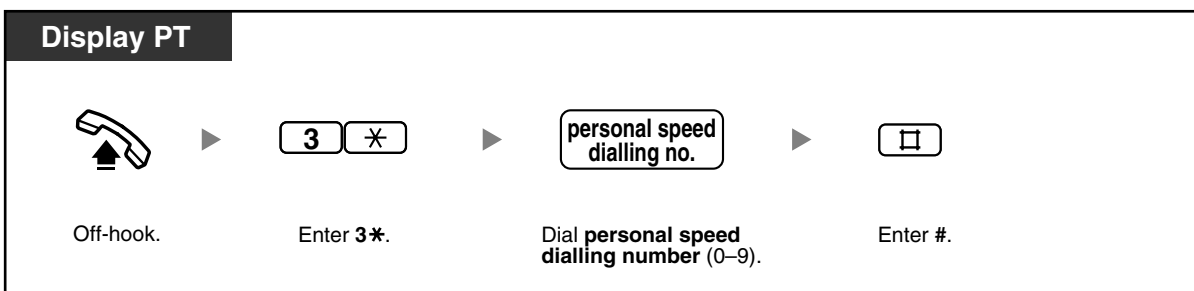

- \* Enter "##" or "1\*" when "Plan 2" or "Plan 3" is selected as the numbering plan through system programming.
- Personal Speed Dialling numbers (0 through 9) correspond to the numbers (F1 through F10) of the Programmable Feature (PF) buttons assigned as One-touch Dialling numbers. Assigning a One-touch Dialling number to PF button "F1" will override Personal Speed Dialling number "0", and vice versa.
- Rotary single line telephone (SLT) users cannot use this feature.
- Up to 24 digits including "\*" can be stored. However, depending on your mode of account code entry, "\*" may not be regarded as a pause.

## ◆◆ Using Numbers Stored in the PBX (System Speed Dialling)

You can make calls using preprogrammed speed dialling numbers (max. 100 codes) stored in the PBX. Ask your manager or dealer about the stored speed dialling numbers.

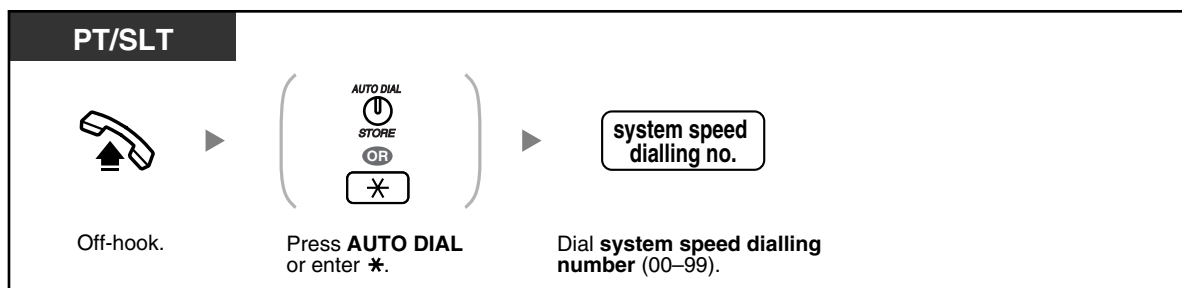

- A telephone number longer than 32 digits can be stored by dividing it among 2 or more System Speed Dialling buttons.

<Example>

If the number is divided and stored in system speed dialling numbers 01 and 02:



- Rotary SLT users cannot use this feature.
- You can press a CO button to select a desired outside (CO) line before pressing the AUTO DIAL/STORE button.

## ◆◆ Dialling a Preset Number by Going Off-hook (Hot Line)

An SLT user can make a call simply by going off-hook, if the telephone number has been stored beforehand. This feature is also known as Pickup Dialling.

### To store a phone number

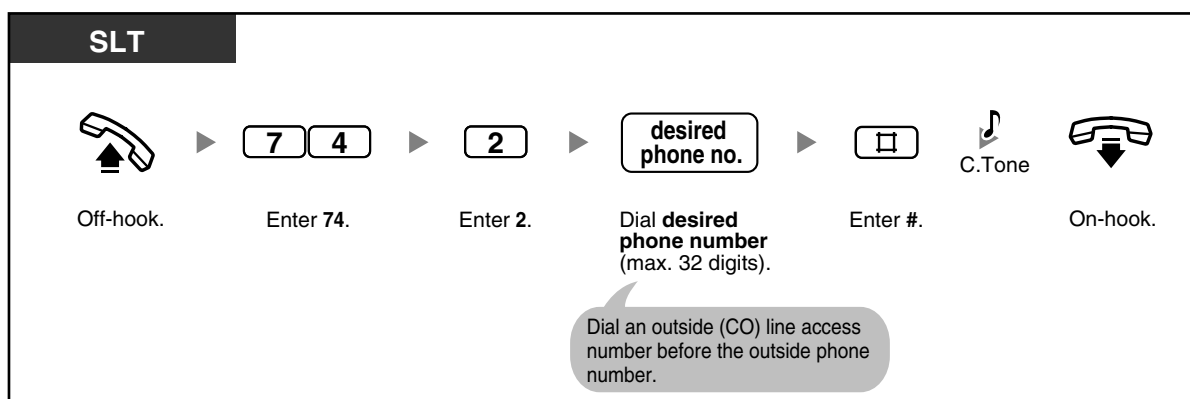

**To set/cancel**

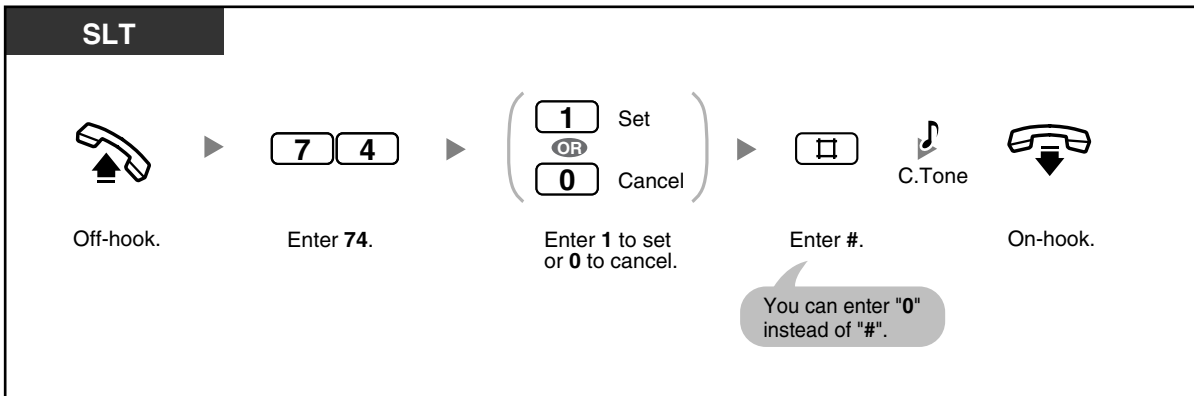

**To dial**



- **To call another party**, dial the desired party's phone number before the preprogrammed number is dialled.
- Up to 32 digits including "\*" can be stored. However, depending on your mode of account code entry, "\*" may not be regarded as a pause.
- Rotary SLT users cannot programme this feature.

**◆◆ Using a Preprogrammed Number (Quick Dialling)**

You can make a call simply by using the preprogrammed code number (50 through 59). For more details, consult your manager or dealer.

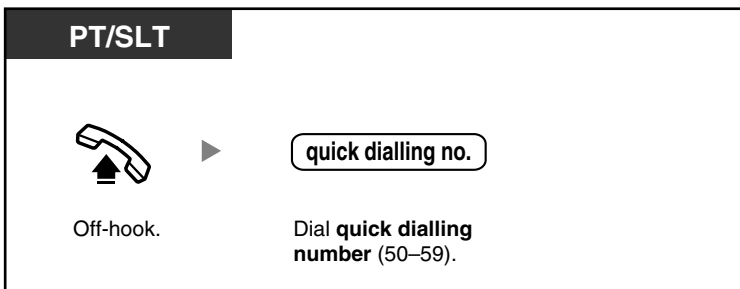

- This feature may be restricted depending on system programming.

## 1.2.3 Redialling

Redial features make it easy to make consecutive calls to the same outside party.

- Redialling the Last Outside Number You Dialed (Last Number Redial)
- Saving an Outside Phone Number for Redialling (Saved Number Redial)



- Up to 64 digits, "\*", "#", PAUSE, and SECRET (INTERCOM) (which stops all or part of the number from being displayed) can be stored and redialled. The outside (CO) line access number is not counted as a digit.
- If you hear a busy tone after pressing the REDIAL or Save button, select another line and then press the REDIAL or Save button or enter the feature number to retry.
- You can confirm the stored number by pressing the REDIAL or Save button while on-hook.



### Automatic Redial

**To redial automatically** (if the called party is currently busy), press the SP-PHONE or MONITOR button and then the REDIAL or Save button. Redialling will be automatically repeated until the called party answers or until a specified time limit is reached. You can perform other tasks while Automatic Redial is being carried out. To cancel, press the FLASH/RECALL button or perform another operation. Automatic Redial is not available for some countries/areas.

### ◆◆ Redialling the Last Outside Number You Dialed (Last Number Redial)

To dial

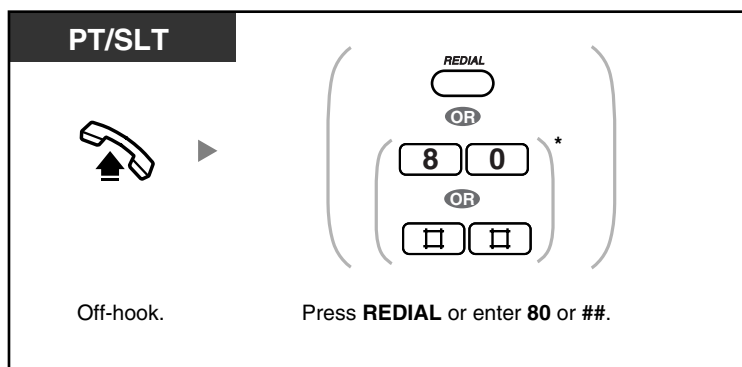

To dial automatically (Automatic Redial)

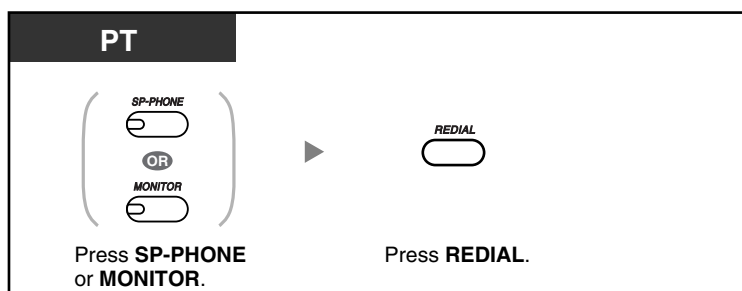

## 1.2 Making Calls



- \* Enter "80" or "###" when "Plan 2" or "Plan 3" is selected as the numbering plan through system programming.
- Pressing the REDIAL button after dialling a telephone number or during a conversation will disconnect the current call and redial the stored number.

### ◆◆ Saving an Outside Phone Number for Redialling (Saved Number Redial)

The saved number remains available until another number is stored.



#### To save

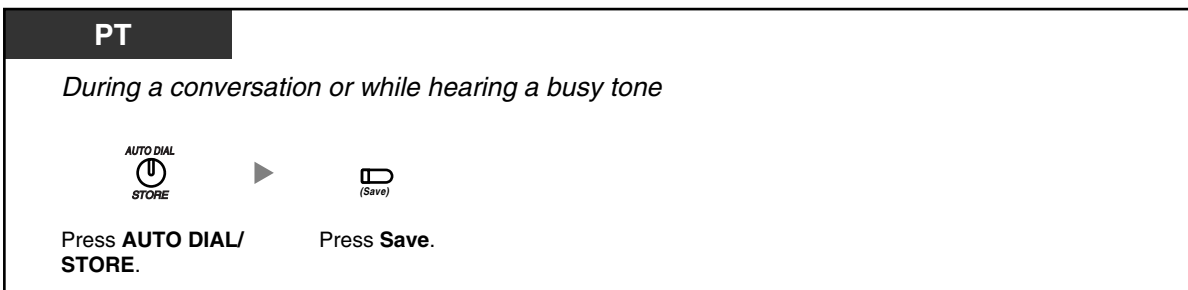

#### To dial



#### To dial automatically (Automatic Redial)



#### Customising Your Phone

- 3.1.3 Customising the Buttons  
Create or edit a Save button.

## 1.2.4 When the Dialed Party is Busy or There is No Answer

- Reserving a Busy Line (Automatic Callback Busy [Camp-on])
- Sending a Call Waiting Tone to a Busy Extension (Busy Station Signalling [BSS])
- Leaving a Message Waiting Indication/Calling Back a Caller Who Left an Indication (Message Waiting)
- Joining an Existing Call (Executive Busy Override)
- Calling an Extension That Is Refusing Calls (DND Override)

### ◆◆ Reserving a Busy Line (Automatic Callback Busy [Camp-on])

If a dialed extension or a desired outside (CO) line is busy, you can set the Automatic Callback Busy feature. Then, when the extension or outside (CO) line becomes idle, your telephone will ring automatically.

When you answer the callback ring:

- a dialed extension becomes idle.
- a desired outside (CO) line that is in use by another extension becomes idle.

You cannot set Automatic Callback Busy for a busy party outside of the PBX.

When you answer the callback ring:

- for an outside (CO) line call: the line is seized.
- for an intercom call: the called extension starts ringing automatically.

#### To set for both an outside (CO) line call and an intercom call

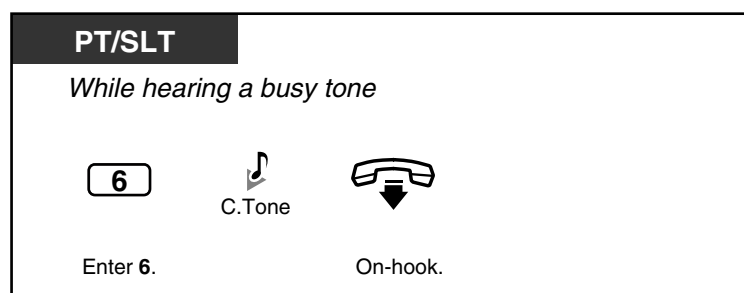

#### To answer a callback ring set for a busy extension

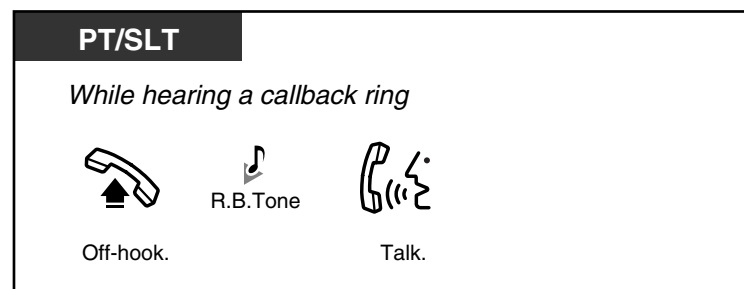

**To answer a callback ring set for a busy outside (CO) line**

**PT/SLT**

*While hearing a callback ring*

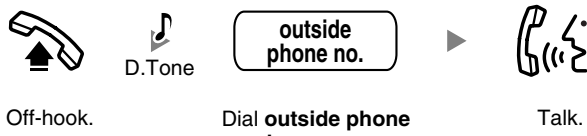

Off-hook.      D.Tone      Dial **outside phone number.**      Talk.



- If you do not answer the callback ring within 10 seconds (4 rings), this feature will be cancelled.

**To cancel the callback ring (Automatic Callback Busy Cancel)**

**PT/SLT**



Off-hook.

**◆◆ Sending a Call Waiting Tone to a Busy Extension (Busy Station Signalling [BSS])**

If the extension that you want to call is busy, you can send a call waiting tone, to inform the extension user that your call is waiting. When the extension user hears this tone, he or she can choose to put the current party on hold, and talk to you.

**PT/SLT**

*While hearing a busy tone after dialling an extension number*



Enter 2.



- **If you hear a reorder tone after dialling an extension number**, this feature is not available for the other party's phone. This feature is only available if the called extension has set Call Waiting. To set Call Waiting, refer to "1.7.3 Receiving Call Waiting". To answer a waiting call, refer to "1.4.4 Answering Call Waiting".



## ◆◆ Leaving a Message Waiting Indication/Calling Back a Caller Who Left an Indication (Message Waiting)

### ◆ Leaving a Message Waiting Indication

When the called extension is busy or does not answer your call, you can leave a notification so that the called party may call you back.

### ◆ Calling Back a Caller Who Left an Indication

When you receive a message waiting indication, the MESSAGE/Message for Another Extension button light or Message/Ringer Lamp will light. You can call back the caller simply by pressing the lit MESSAGE/Message for Another Extension button.

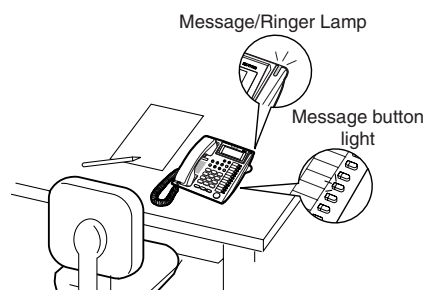

### ◆ Leaving a Message Waiting Indication

To leave a message waiting indication

**PT**

*When the called extension is busy or does not answer*



Press **MESSAGE**.



C.Tone



On-hook.

To leave/cancel a message waiting indication

**PT/SLT**



Off-hook.

7

0

Enter **70**.

1

Leave

OR

2

Cancel

Enter 1 to leave or 2 to cancel.

desired extension no.

Dial **desired extension number**.

#

Enter #.



C.Tone



On-hook.

An SLT user can enter "0" instead of "#".

**To cancel a message waiting indication using the MESSAGE button**

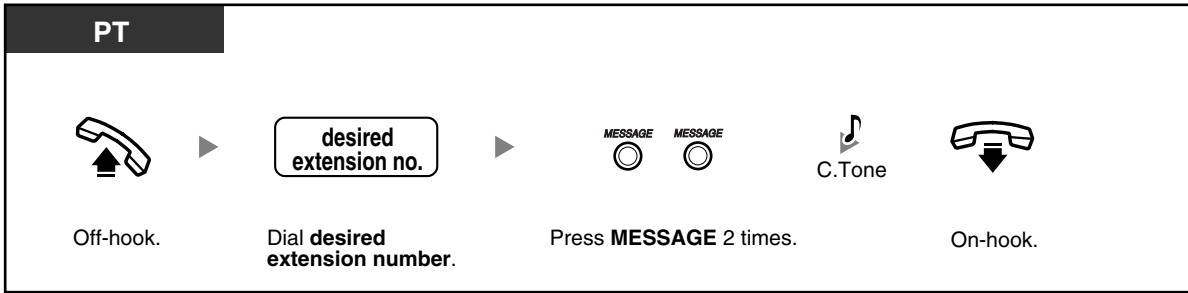

**◆ Calling Back a Caller Who Left an Indication**

**To check a received message and call back**

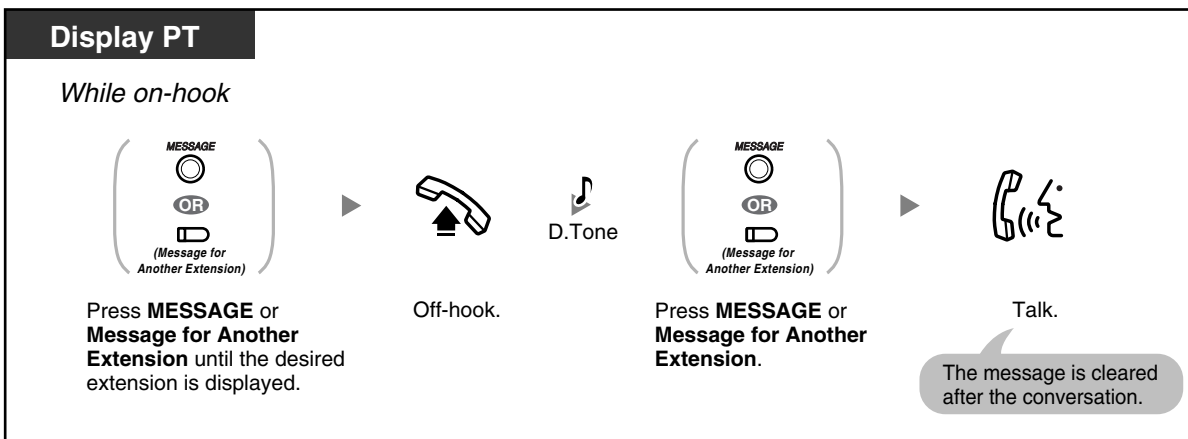

**To cancel all message waiting indications left at your extension**

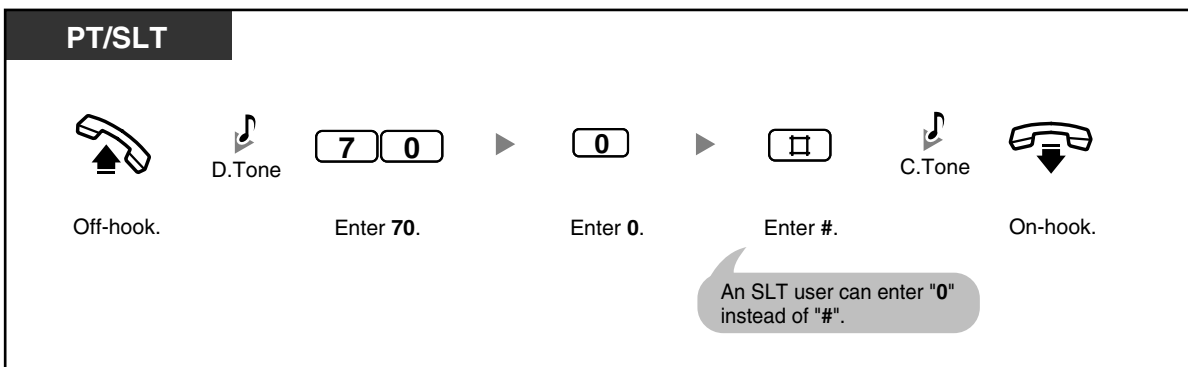

**To cancel all message waiting indications left at another extension**

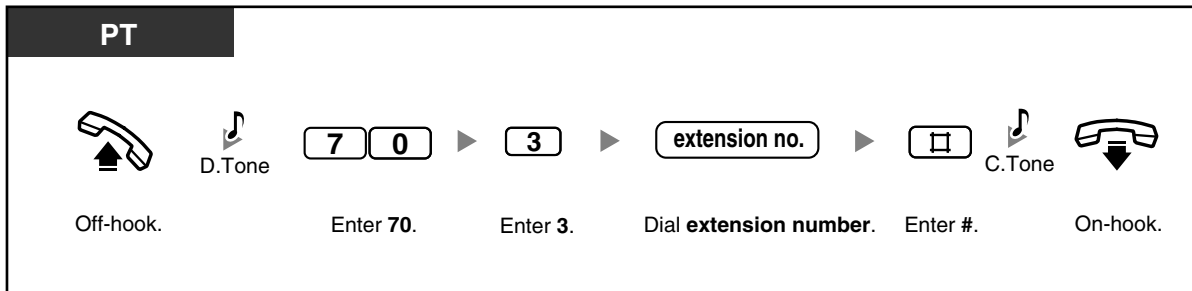

**To lock/unlock message waiting indications**

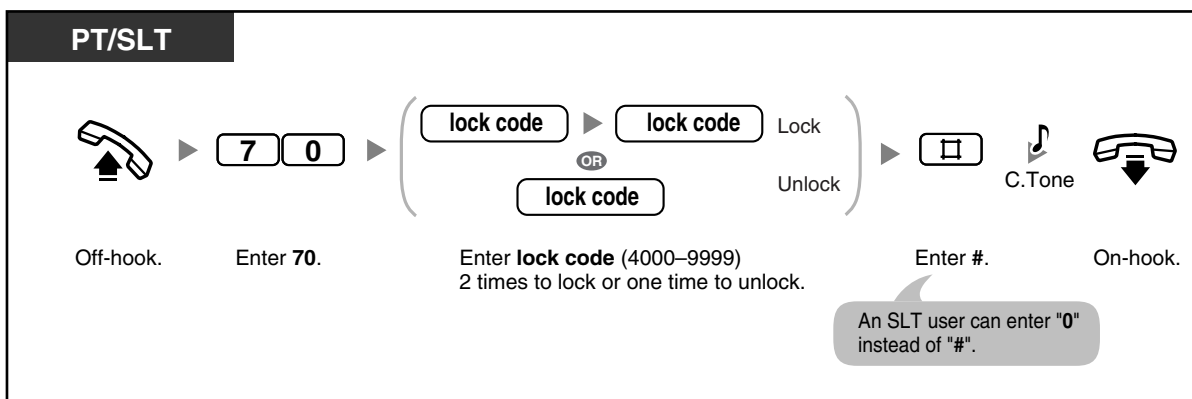



- You can lock message waiting indications so that other extensions cannot confirm, call back, or clear message waiting indications left at your extension (Message Waiting for Another Extension Lock). The operator or manager can cancel this feature for all extensions (Extension Lock—CANCEL ALL). Even while this lock is on, you can confirm, call back, or clear message waiting indications left at your own extension.
- On your proprietary telephone (PT), you can establish one or more Message for Another Extension buttons. These buttons can display message waiting indications left at other telephones.
- To cancel all message waiting indications left at another extension**, it is necessary to first assign the corresponding Message for Another Extension buttons on your phone.
- The MESSAGE/Message for Another Extension button light or Message/Ringer Lamp shows the current status as follows:  
**Off:** No messages  
**Red on:** New messages.
- The display shows messages in the order received, starting with the selected message.  
**<Example>**  
 5→6→7→8→1→2→3→4
- The MESSAGE button is used to perform operations and display notifications from both the Message Waiting and Built-in Voice Message (BV) features. If a message has also been left in a voice message area, "voice message" will be shown on a display PT when the MESSAGE button is pressed. Refer to "1.5.5 Using Voice Messaging (Built-in Voice Message [BV])".
- Each extension can have a maximum of 8 messages waiting when using the Message Waiting feature, or a maximum of 125 voice messages waiting when using the BV feature.
- If you go off-hook with a single line telephone (SLT) that has messages waiting, a special dial tone (dial tone 3) will be heard. You can call a caller back or listen to the message by entering the Message Waiting Answer feature number, "784# (7840)".



**Customising Your Phone**

- 3.1.3 Customising the Buttons  
 Create or edit a Message button or Message for Another Extension button.

**◆◆ Joining an Existing Call (Executive Busy Override)**

You can join an ongoing conversation, establishing a 3-party conference call, if your extension is permitted through system programming.

**To join an outside (CO) line call**

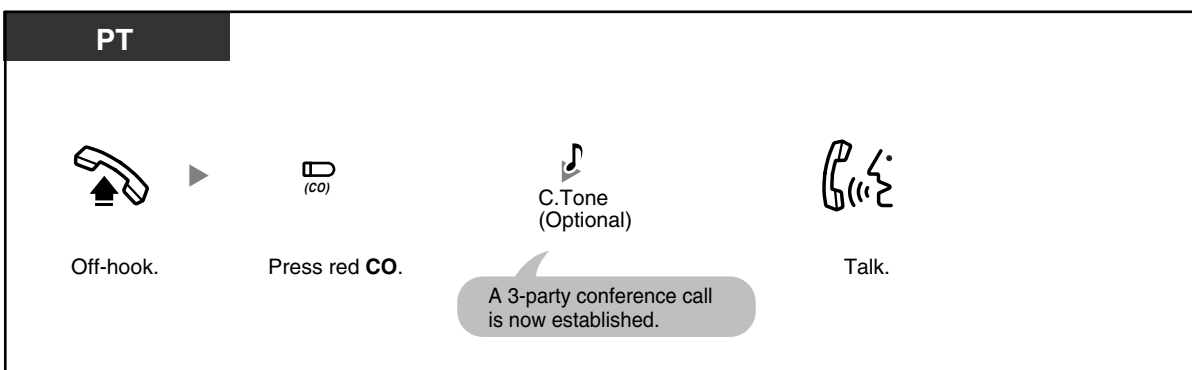

### To join an intercom call

**PT/SLT**

While hearing a busy tone

**3**

Enter 3.

 C.Tone (Optional)

 Talk.

A 3-party conference call is now established.

### To disconnect one party and talk with another when one of the parties is an outside party

**PT**

 (CO)

 OR

 INTERCOM

Press CO or INTERCOM.

 Talk.

### To leave the conference call

**PT/SLT**



On-hook.

The other 2 parties can continue their conversation.



- You can also prevent others from joining your conversations. Refer to "1.7.4 Preventing Other People from Joining Your Conversation (Executive Busy Override Deny)".

### ◆◆ Calling an Extension That Is Refusing Calls (DND Override)



You can call users who have set the Do Not Disturb (DND) feature, if your extension is permitted through system programming.

## 1.2 Making Calls

---

**PT/SLT**

*While hearing the DND tone*

Enter 2.                      Talk.



- If you hear the DND tone, enter "2", and then hear a busy tone, the called extension is busy. You can use the Automatic Callback Busy feature.

## 1.2.5 Switching the Calling Method (Alternate Calling—Ring/Voice)



Extension users can choose whether to be alerted to incoming calls by ringing or by the caller's voice. The calling extension can override this choice and use the alternate method.

**Ring (Default):** You can call the other party with a ring tone. You will hear a ringback tone.

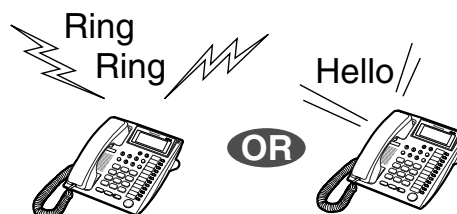
**Voice-calling:** You can talk to the other party immediately after hearing a confirmation tone. You will not hear a ringback tone. You will not be able to hear the other party's voice until he or she answers the call.



### To switch the calling method

PT/SLT		
<i>After dialling an extension number</i>		
 Enter * .	 C.Tone or R.B.Tone	 Talk.



- If the called party uses a single line telephone (SLT), Voice-calling is not available.
- Rotary SLT users cannot use this feature.



### Customising Your Phone

- 3.1.2 Changing Personal Settings Using Programming Mode—**Alternate Receiving—Ring/Voice**  
Select the alerting method, either ring or the other party's voice.

## 1.2.6 Using Your Calling Privileges at Another Extension (Walking COS)

You can use your calling privileges (class of service [COS]) at another extension, to override calling restrictions that have been set at that extension. To use this feature, a preprogrammed extension password is required. Ask your manager for the extension password.

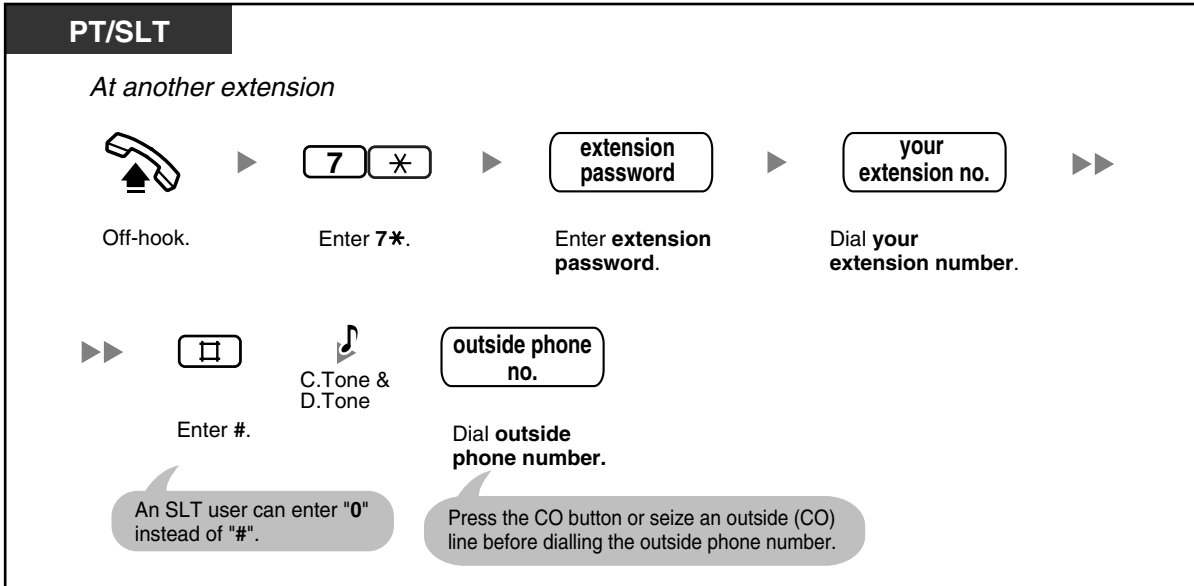

- Rotary single line telephone (SLT) users cannot use this feature.



## 1.2.7 Accessing Another Party Directly from Outside (Direct Inward System Access [DISA])

When an outside caller dials a specified telephone number of the PBX, a prerecorded Direct Inward System Access (DISA) outgoing message (OGM) can greet the caller and give information about how to access an extension. The operator does not need to be involved. If there is no recorded message, the caller will hear a short beep instead of the DISA OGM.

The caller may also be able to access system features or call an outside party by using the caller's password (DISA security code), depending on the security mode. Ask your manager about the mode assigned to your PBX.

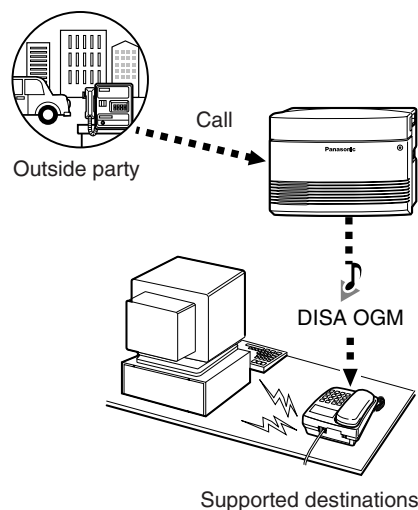

### To call an extension

#### From an Outside Telephone

##### ● In No Security Mode/Trunk Security Mode



Off-hook.



DISA  
phone no.

Dial **DISA**  
phone number.



R.B.Tone &  
DISA OGM  
(or one short beep)

desired  
extension no.

Dial **desired**  
extension number.



R.B.Tone

You can dial the preprogrammed  
AA number instead.

##### ● In All Security Mode



Off-hook.



DISA  
phone no.

Dial **DISA**  
phone number.



R.B.Tone &  
DISA OGM  
(or one short beep)

\*.

Enter \*.

DISA security code

Enter **DISA security code**  
(4–10 digits).



One short beep

desired  
extension no.

Dial **desired**  
extension number.



R.B.Tone

You can dial the preprogrammed  
AA number instead.

### To call an outside party

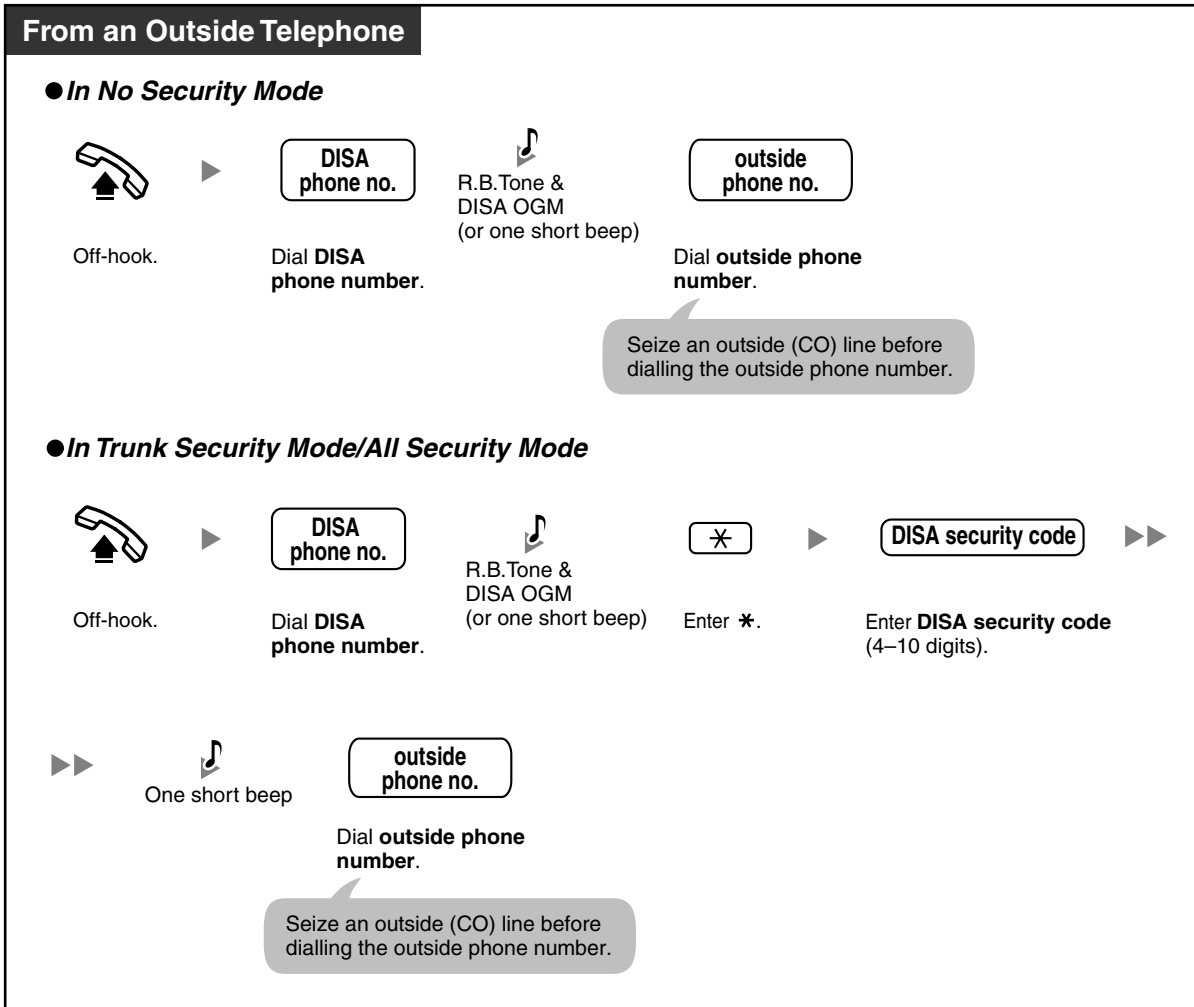



- **WARNING**  
There is a risk that fraudulent telephone calls will be made using the Outside-to-Outside (CO-to-CO) Line Call feature of DISA.  
The cost of such calls will be billed to the owner/renter of the PBX.  
To protect the PBX from this kind of fraudulent use, we strongly recommend:
  - a) Enabling DISA security (Trunk Security or All Security).
  - b) Keeping DISA security codes secret.
  - c) Selecting complex, random codes that cannot be easily guessed.
  - d) Changing codes regularly.
- If you dial 4 digits or more when dialling an extension number, the call will be disconnected. When you dial an invalid extension number of 3 digits or less, the call is redirected to the preprogrammed intercept destinations or disconnected, according to system programming.
- **CO-to-CO Line Call Duration**  
The length of outside-to-outside (CO-to-CO) line calls may be limited through system programming.  
Both the outside caller and the outside destination will hear a warning tone 15 seconds before a specified time limit. When the timer expires, the call is disconnected.
- If the DISA Automated Attendant (AA) service is used, you can access the desired party simply by pressing a preprogrammed single-digit number (DISA AA number) while or after hearing a DISA OGM or after a short beep. AA menus can be up to 3 levels deep.
- If you enter an invalid security code 3 times consecutively, the call will be disconnected automatically. If you enter a DISA security code a second and third time, dialling "\*" is not necessary.



### Customising Your System



- 3.3.2 System Programming—DISA Security Code [512]

## 1.3 Receiving Calls

### 1.3.1 Answering Calls

**PT/SLT**

When your telephone rings, either the CO/INTERCOM button or the Message/Ringer Lamp flashes.

Off-hook.                      Talk.

Select one of the following methods:

- Lift the handset to receive the call on the preferred line. (Default: Ringing line is selected.)
- Press the SP-PHONE button.
- Press the flashing CO or INTERCOM button directly.



- **Hands-free Operation**

You can receive a call and have a conversation in hands-free mode using the SP-PHONE button. Refer to "1.4.8 Talking to Another Party without Lifting the Handset (Hands-free Operation)".



- **Customising Your Phone**

- 3.1.2 Changing Personal Settings Using Programming Mode—**Line Preference—Incoming**

Select the method used to answer incoming calls.

- **Alternate Receiving—Ring/Voice**

Select the Calling method, either ring or the other party's voice.

## 1.3.2 Answering Hands-free (Hands-free Answerback)

You can set your proprietary telephone (PT) to answer incoming intercom calls without going off-hook. When an intercom call arrives, you will hear the caller talking without the phone ringing.



### To set/cancel

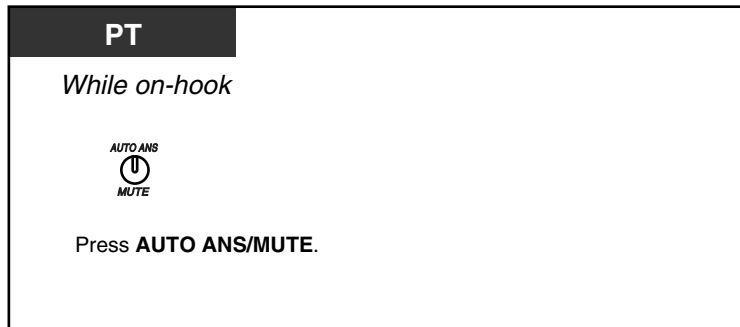

- The AUTO ANS/MUTE button light shows the current status as follows:
  - Off:** Not set
  - Red on:** Set
- This feature is not available for incoming outside (CO) line calls and doorphone calls.

### 1.3.3 Answering a Call Ringing at Another Telephone (Call Pickup)

- Answering a Call from Another Telephone (Call Pickup)
- Preventing Other People from Picking Up Your Calls (Call Pickup Deny)

#### ◆◆ Answering a Call from Another Telephone (Call Pickup)

Without leaving your desk, you can answer an incoming call that is ringing at another extension or your extension group, or that was received by a preprogrammed Telephone Answering Machine (TAM) extension from your phone.

The following types of call pickup are available:

- Group Call Pickup:** Picks up a call within your group.
- Directed Call Pickup:** Picks up a specific extension's call.
- Call Retrieving from a TAM:** Retrieves a call on a TAM.

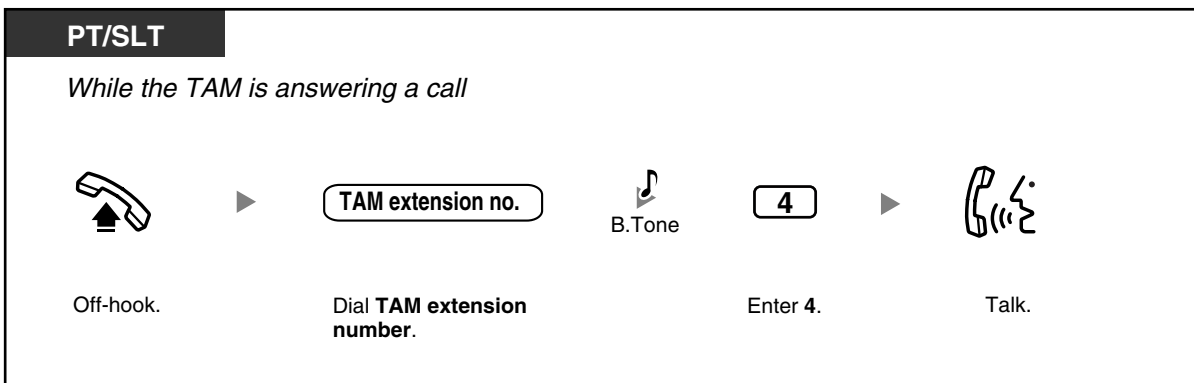
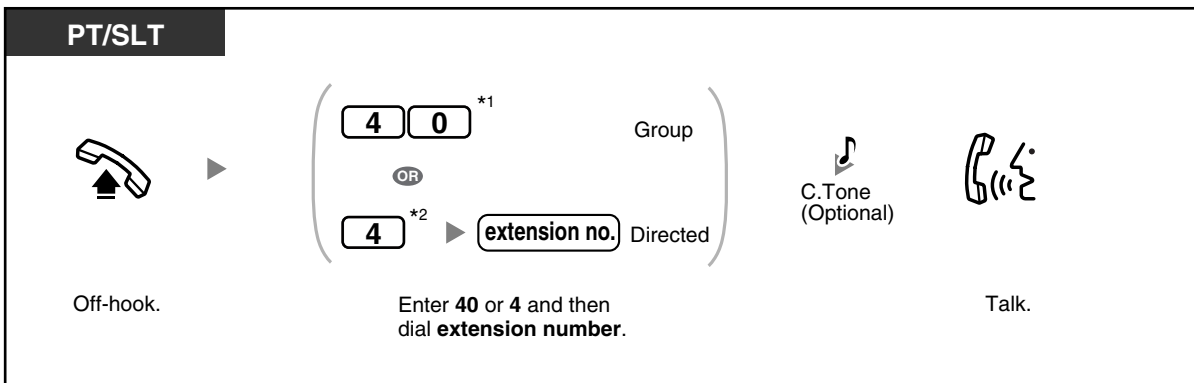

- \*1 Enter "#40" when "Plan 2" or "Plan 3" is selected as the numbering plan through system programming.
- \*2 Enter "#41" when "Plan 2" or "Plan 3" is selected as the numbering plan through system programming.
- By setting system programming in advance, you can pick up a call to another extension in the same extension group simply by going off-hook, even if your extension is not ringing.
- **!!** If you hear a reorder tone when trying to retrieve a call from a TAM, the dialled extension is not the TAM extension, or the TAM cannot answer the call because it is performing another operation.

## ◆◆ Preventing Other People from Picking Up Your Calls (Call Pickup Deny)

You can prevent other extension users from picking up your calls.

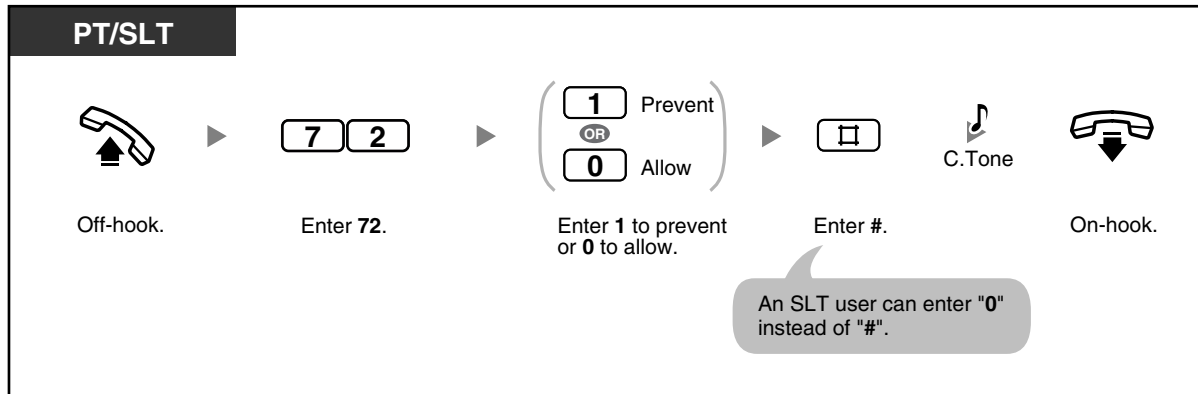

# 1.4 During a Conversation

## 1.4.1 Transferring a Call (Call Transfer)

- Transferring to an Extension within the PBX
- Transferring to an Outside Destination

### ◆◆ Transferring to an Extension within the PBX

You can transfer incoming calls to another extension. Depending on the setting of your PBX, proprietary telephone (PT) users may also be able to transfer incoming outside (CO) line calls to another extension simply by pressing the corresponding Direct Station Selection (DSS) button (One-touch Transfer).

#### To transfer

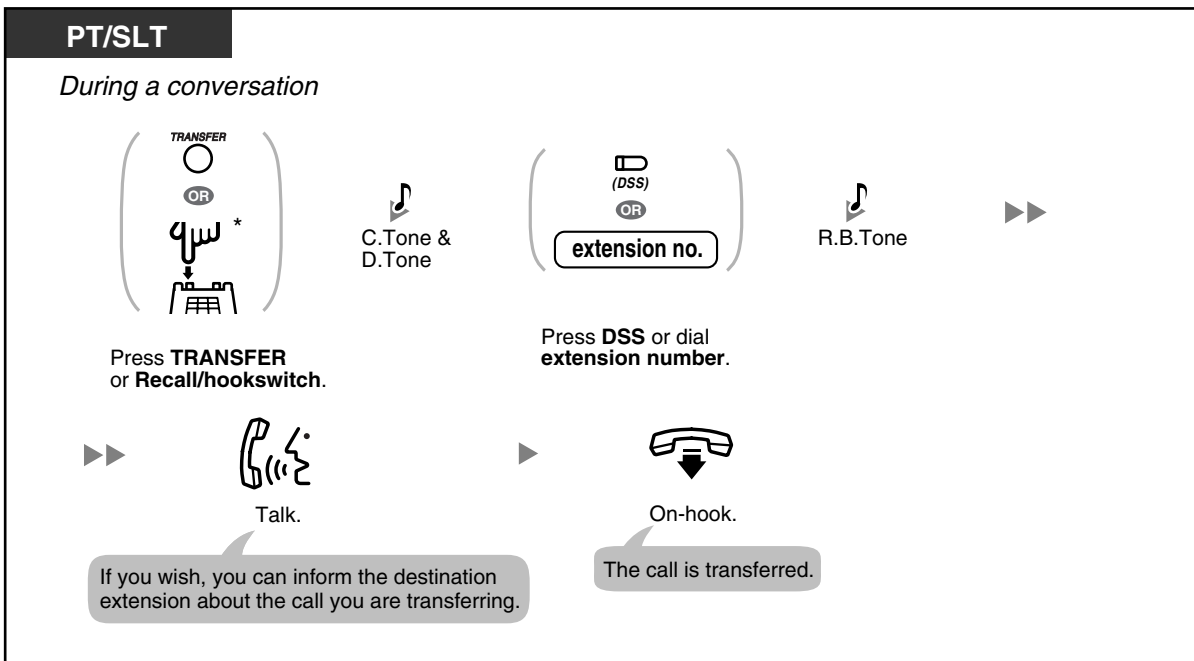

#### To transfer with a one-touch operation (One-touch Transfer)

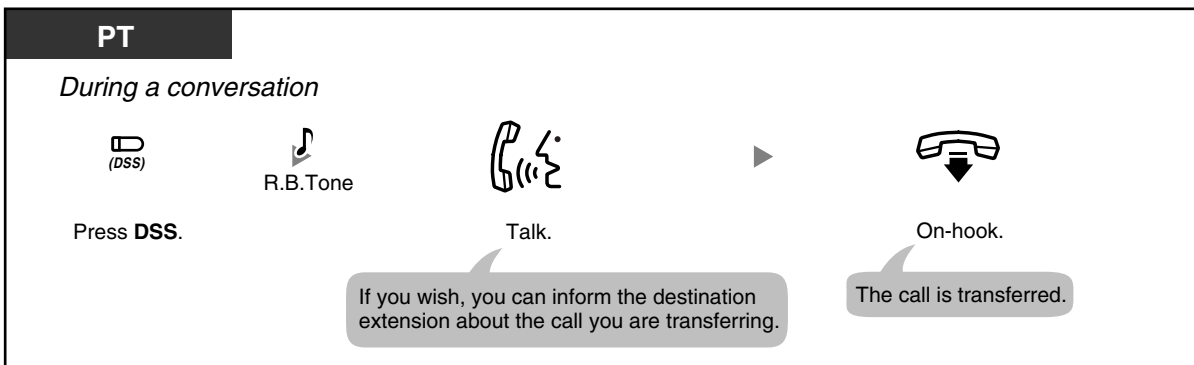





- \* You may have to enter the Call Hold feature number after pressing the Recall/hookswitch on your single line telephone (SLT), depending on the SLT Hold Mode of your PBX.  
Call Hold feature number:
  - Plan 1: 20 (United Kingdom/New Zealand: 50)
  - Plan 2/Plan 3: #20 (United Kingdom/New Zealand: #50)
 Ask your manager or dealer about the mode assigned to your PBX.
- You can go on-hook before the destination extension answers the call. If the destination extension does not answer the call within a specified time period, you will hear an alarm tone, and the call will return to you. If you do not answer the call within 30 minutes after it returns to you, the call will be disconnected.
- When the dialled extension is busy, you may access the extension by entering "2" (Busy Station Signalling [BSS]) or "3" (Executive Busy Override) and then going on-hook.

## ◆◆ Transferring to an Outside Destination

You can transfer incoming calls to outside destination when your PT is permitted through system programming.

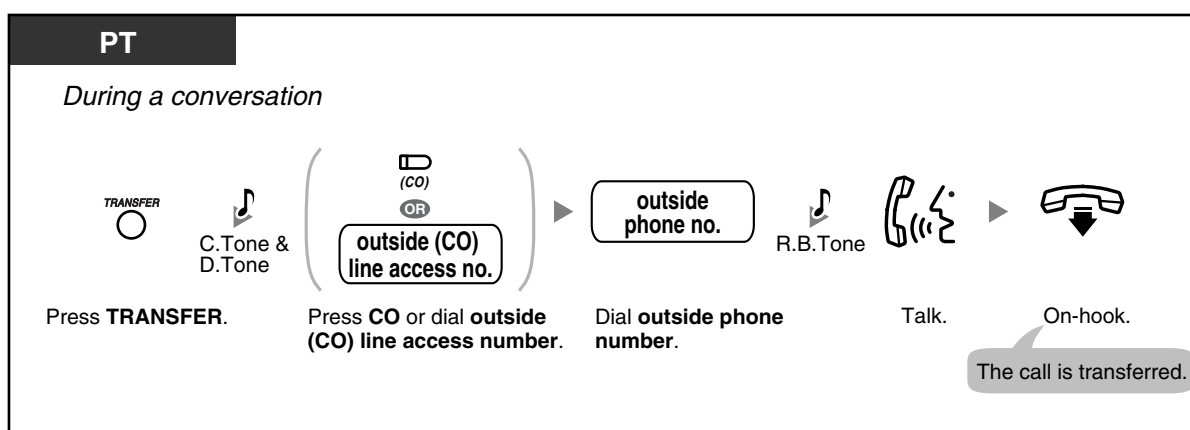

- CO-to-CO Line Call Duration**  
The length of outside-to-outside (CO-to-CO) line calls may be limited through system programming. Both the outside caller and the outside destination will hear a warning tone 15 seconds before a specified time limit. When the timer expires, the call is disconnected.
- To return to the held call before the destination answers**, press the TRANSFER button or corresponding CO/INTERCOM button.
- After transferring the call to an outside party, you can join the call by pressing the CO button that you used to transfer the call. A 3-party conference call is established (Conference).
- To change the transfer destination before going on-hook, press the CO button whose indicator is flashing slowly to retrieve the call, then repeat the Call Transfer procedure.



### Customising Your Phone

- 3.1.3 Customising the Buttons  
Create or edit a Direct Station Selection (DSS) button.

## 1.4.2 Holding a Call

- Holding
- Holding in a System Parking Zone (Call Park)



- **If a call is not retrieved within a specified time period**, you will hear a ring tone. If you are having a conversation with another party at that time, you will hear an alarm tone. If an outside (CO) line call is not retrieved within 30 minutes of being put on hold, it will be automatically disconnected.

### ◆◆ Holding

There are 2 types of Call Hold mode. The difference between them is whether other people can retrieve the held call (General Call Hold) or not (Exclusive Call Hold).

#### To hold (General Call Hold)

**PT/SLT**

*During a conversation*

Press **HOLD** or **Recall/hookswitch**.

If an SLT connected in parallel with a PT makes another call after going on-hook, the call on hold is transferred to the called party.

#### To hold (Exclusive Call Hold)

**PT**

*During a conversation*

Press **HOLD**.      Press **HOLD** again.      On-hook.

## To retrieve a call (Call Hold Retrieve)

**PT/SLT**

- **At the holding extension (Call Hold Retrieve)**

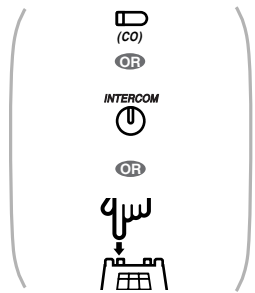

▶



Press flashing **CO** or **INTERCOM**.  
Or press **Recall/hookswitch**.

Talk.

If the handset has been replaced, just go off-hook.  
(SLT only, excluding an SLT in parallel with a PT)
  
- **To retrieve an outside (CO) line call put on hold (General Call Hold) by another extension**



▶



▶

5

3

▶

held line no.

▶



Off-hook.

Press **CO**, or enter **53** and then dial **held line number**.

Talk.
  
- **To retrieve an intercom call put on hold (General Call Hold) by another extension**



▶

5

▶

holding extension no.

▶



Off-hook.

Enter **5**.

Dial **holding extension number**.

Talk.

## 1.4 During a Conversation



- \*1 You may have to enter the Call Hold feature number after pressing the Recall/hookswitch on your single line telephone (SLT), depending on the SLT Hold Mode of your PBX.  
Call Hold feature number:
  - Plan 1: 20 (United Kingdom/New Zealand: 50)
  - Plan 2/Plan 3: #20 (United Kingdom/New Zealand: #50)
 Ask your manager or dealer about the mode assigned to your PBX.
- \*2 Enter "#59" when "Plan 2" or "Plan 3" is selected as the numbering plan through system programming.
- \*3 Enter "#5" when "Plan 2" or "Plan 3" is selected as the numbering plan through system programming.
- The CO or INTERCOM button light shows the current status as follows:
  - General Call Hold mode  
**Flashing green slowly:** You have a call on hold.
  - Exclusive Call Hold mode  
**Flashing red slowly:** Another extension has a call on hold.
  - Exclusive Call Hold mode  
**Flashing green at moderate speed:** You have a call on hold.
  - Exclusive Call Hold mode  
**Red on:** Another extension has a call on hold.
- **Hold Mode Change (proprietary telephone [PT] only)**  
Pressing the HOLD button again while a call is on hold switches the status from General Call Hold mode to Exclusive Call Hold mode, or vice versa.
- You cannot hold doorphone calls.



- An SLT user can hold either one intercom call or one outside (CO) line call at a time, while a PT user can hold one intercom call and multiple outside (CO) line calls. To hold multiple calls, use the Call Park feature.

### ◆◆ Holding in a System Parking Zone (Call Park)

You can put a call on hold in a common parking zone of the PBX so that any extension can retrieve the parked call. Up to 10 calls can be parked in the PBX.

#### To park a call

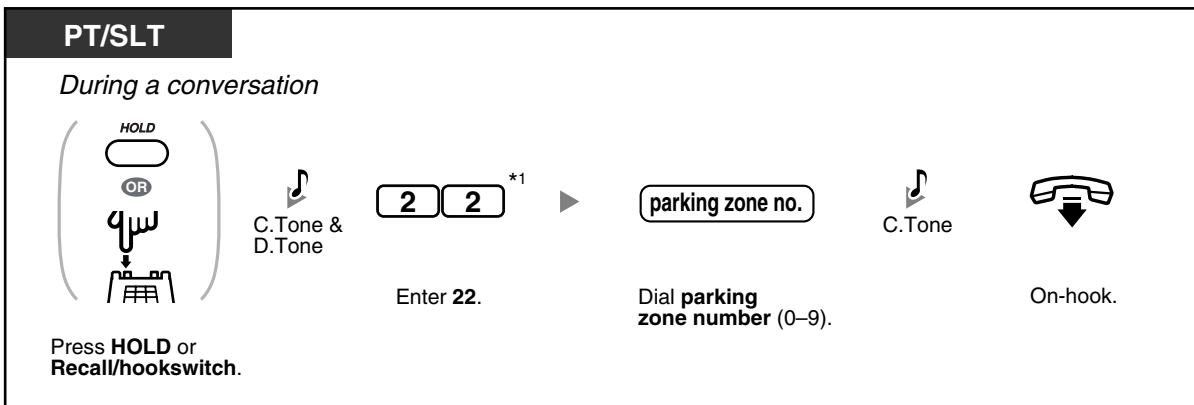

### To retrieve (Call Park Retrieve)

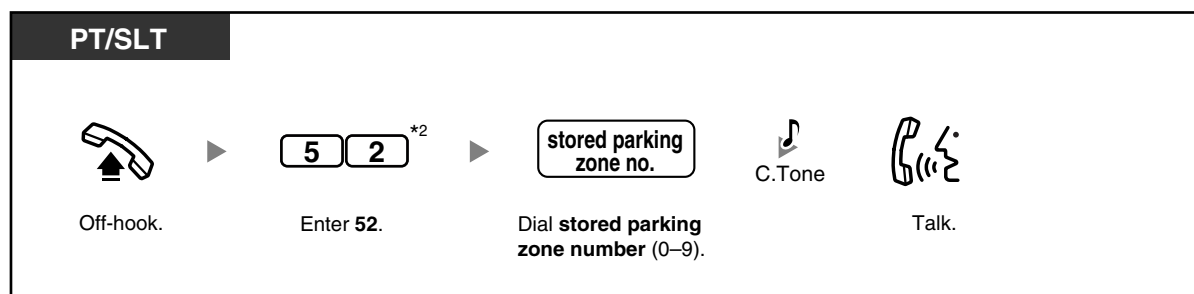

- \*1 Enter "#22" when "Plan 2" or "Plan 3" is selected as the numbering plan through system programming. For United Kingdom/New Zealand, enter "36" when "Plan 1" is selected or enter "#36" when "Plan 2" or "Plan 3" is selected.
- \*2 Enter "#56" when "Plan 2" or "Plan 3" is selected as the numbering plan through system programming. For United Kingdom/New Zealand, enter "56" when "Plan 1" is selected.



- **If you hear a busy tone when parking a call**, the parking zone is unavailable. Dial another parking zone number directly.
- **If you hear a reorder tone when retrieving a parked call**, there is no held call in that location. Confirm the stored parking zone number.
- After you park a call, you can perform other operations.

### 1.4.3 Talking to 2 Parties Alternately (Call Splitting)

When talking to one party with another party on hold, you can switch between the 2 parties.

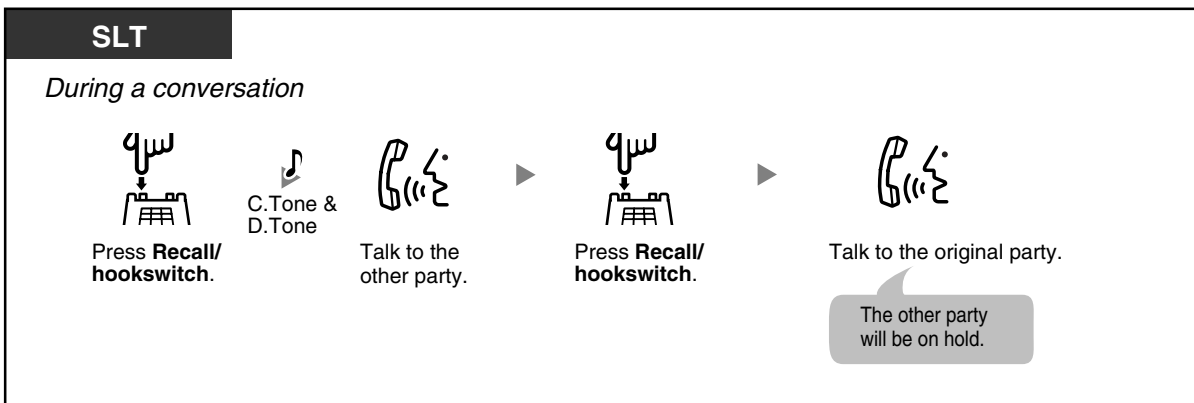
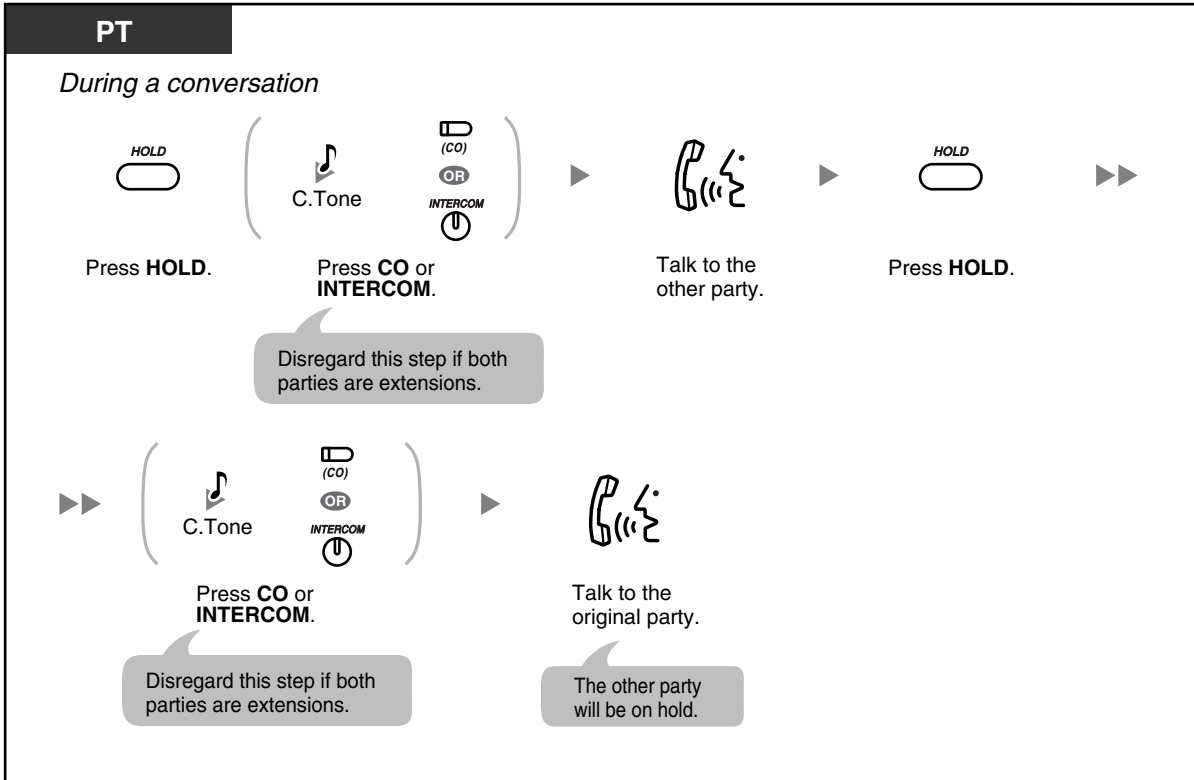

- This feature is not available for calls from doorphones or paging announcements.

## 1.4.4 Answering Call Waiting

- Answering Call Waiting in the PBX
- Answering Call Waiting from the Telephone Company

### ◆◆ Answering Call Waiting in the PBX

During a conversation, a call waiting tone is heard through the speaker or handset when either an outside (CO) line call is received, or another extension is letting you know that a call is waiting. You must activate this feature to be able to use it (Default: Disable). To set Call Waiting, refer to "1.7.3 Receiving Call Waiting".

**You can answer the second call by**

- 1) disconnecting the current call;**
- 2) placing the current call on hold.**

#### 1. To disconnect the current call and then talk to the new party

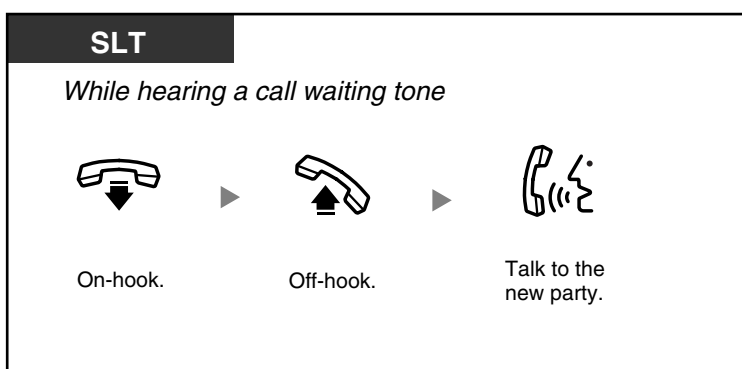
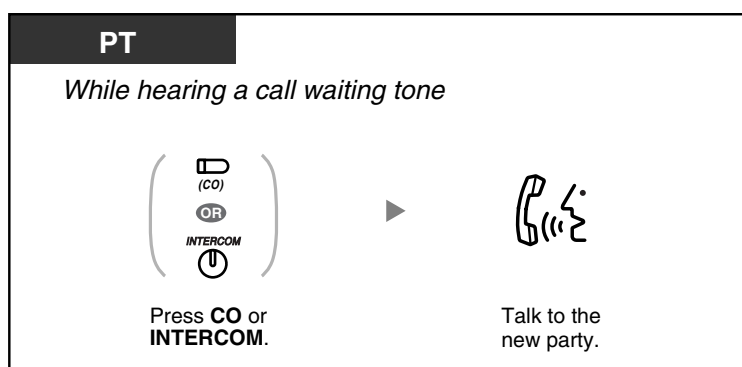

2. To hold the current call and then talk to the new party

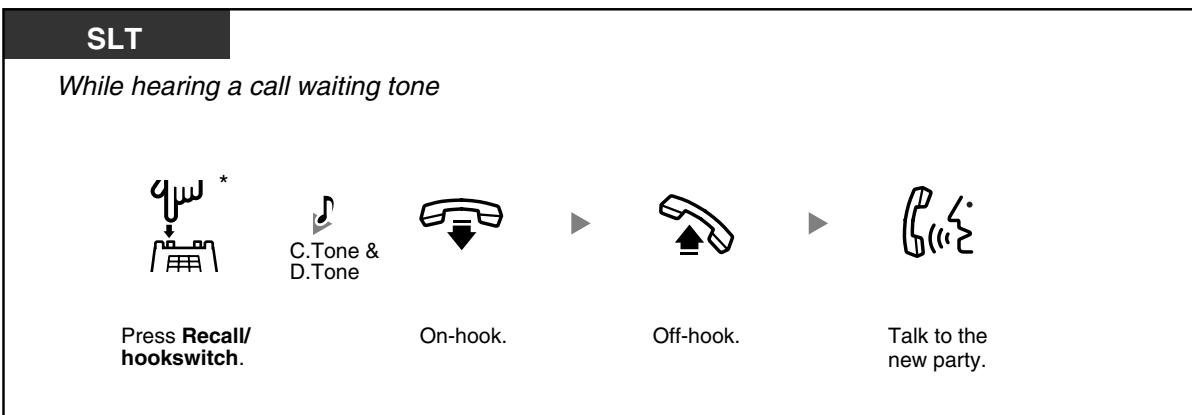
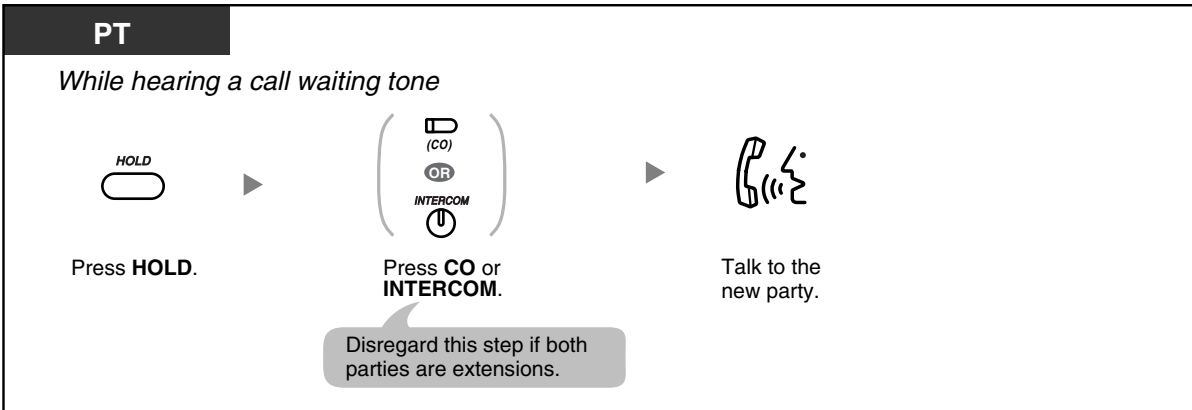

- \* You may have to enter the Call Hold feature number after pressing the Recall/hookswitch on your single line telephone (SLT), depending on the SLT Hold Mode of your PBX. Call Hold feature number:
  - Plan 1: 20 (United Kingdom/New Zealand: 50)
  - Plan 2/Plan 3: #20 (United Kingdom/New Zealand: #50)Ask your manager or dealer about the mode assigned to your PBX.
- An SLT user cannot transfer a new call while holding the current call. To transfer the new call, first park the original call using the Call Park feature, then go on-hook and off-hook.





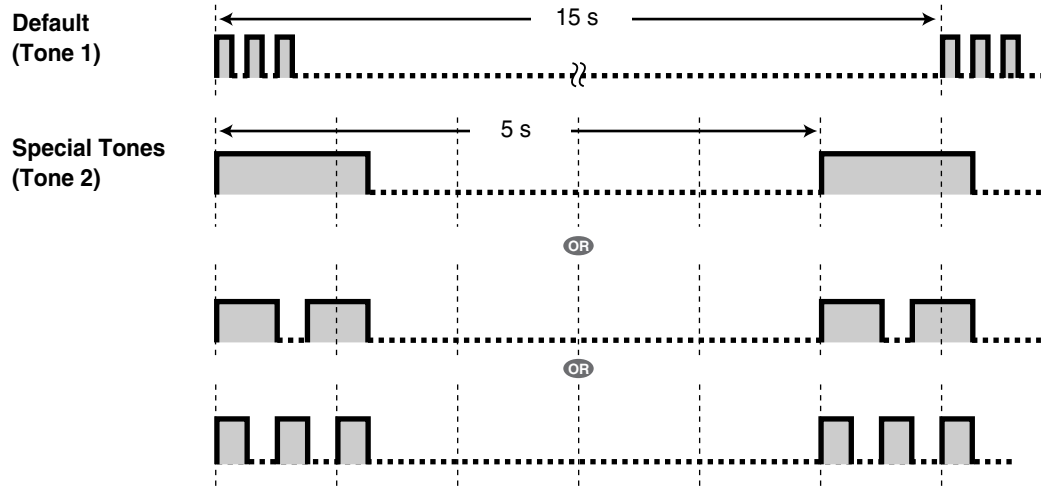

**Customising Your Phone**

- 3.1.2 Changing Personal Settings Using Programming Mode—**Call Waiting Tone Type Selection**



◆◆ **Answering Call Waiting from the Telephone Company**

Your telephone company may also offer an optional call waiting service, which can inform you that you have another call on the same outside (CO) line. For more details, consult your telephone company.

PT	SLT
<p><i>While hearing a call waiting tone</i></p> <p style="text-align: center;">FLASH/RECALL ○</p> <p>Press <b>FLASH/RECALL</b>.</p>	<p><i>While hearing a call waiting tone</i></p> <div style="display: flex; justify-content: space-around; align-items: center;"> <div style="text-align: center;">  <p>Press <b>Recall/hookswitch</b>.</p> </div> <div style="text-align: center;">  <p>C.Tone &amp; D.Tone</p> </div> <div style="text-align: center;"> <div style="border: 1px solid black; border-radius: 10px; width: 30px; height: 30px; display: flex; align-items: center; justify-content: center;">6</div> <p>Enter 6.</p> </div> </div>

### 1.4.5 Talking to Multiple Parties (Conference)

- Adding a Third Party During a Conversation (3-party Conference)
- Leaving a Conference Call (Unattended Conference)
- Originating a 3-party to 5-party Conference Call (5-party Conference)

#### ◆◆ Adding a Third Party During a Conversation (3-party Conference)

You can add a third party to your conversation.

##### To establish a 3-party conference call

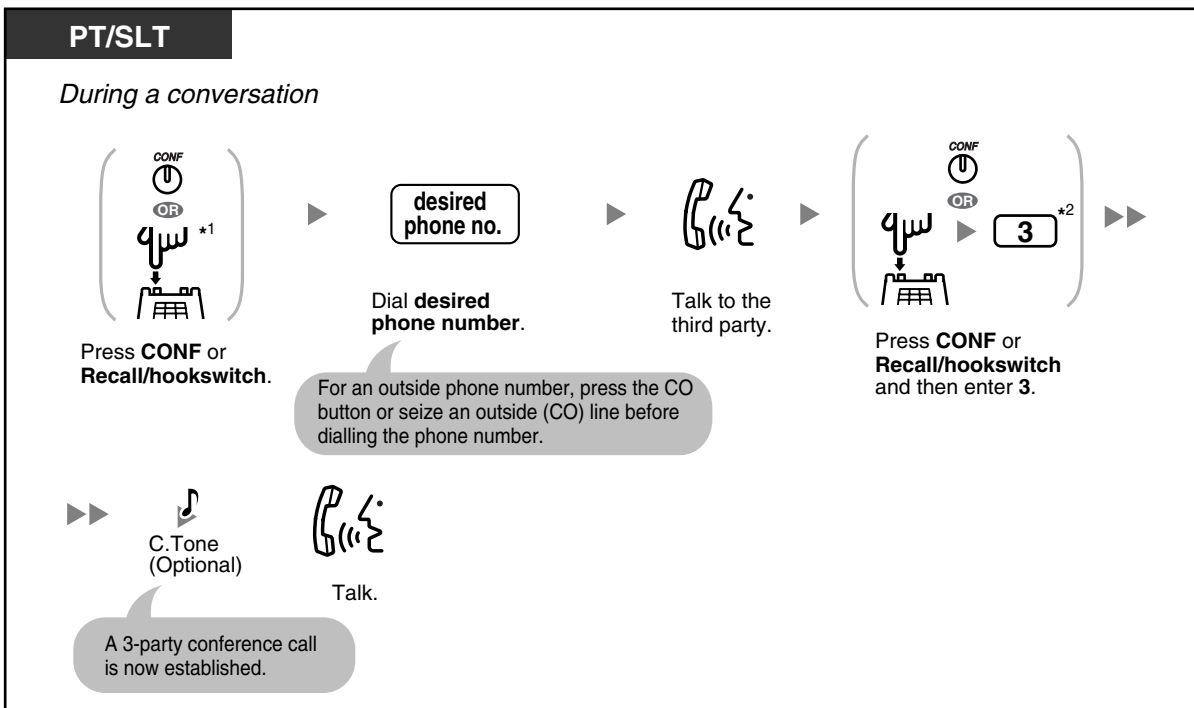

##### To disconnect one party and then talk to the other

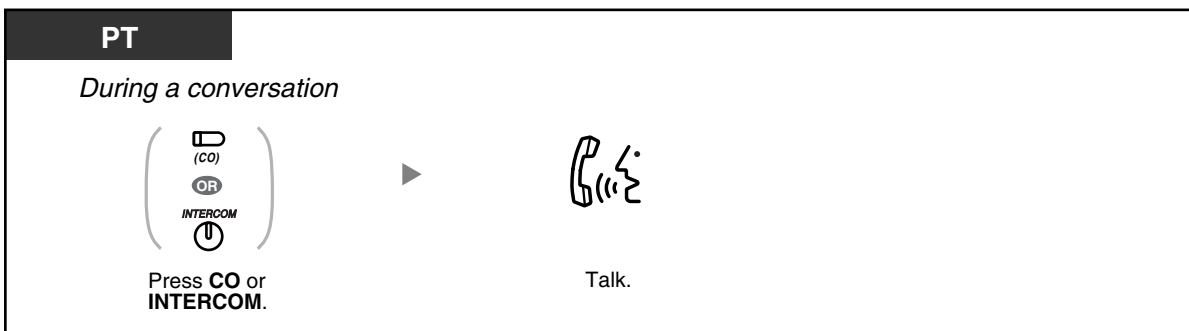

### To put the third party on hold and talk to the original party

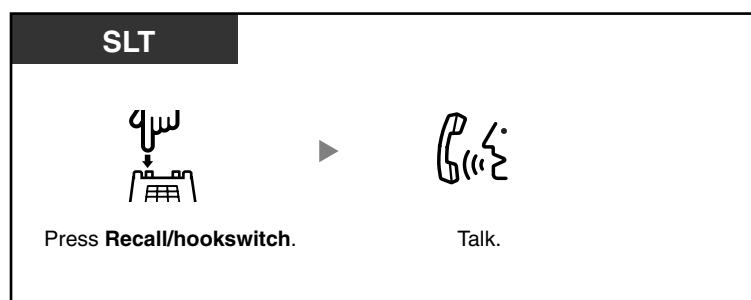

### To leave a 3-party conference call

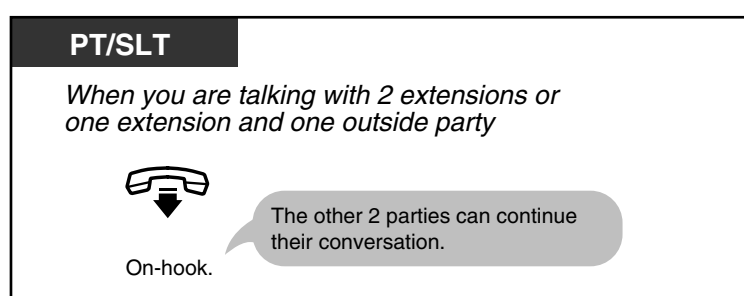

- \*1 You may have to enter the Call Hold feature number after pressing the Recall/hookswitch on your single line telephone (SLT), depending on the SLT Hold Mode of your PBX.  
Call Hold feature number:
  - Plan 1: 20 (United Kingdom/New Zealand: 50)
  - Plan 2/Plan 3: #20 (United Kingdom/New Zealand: #50)
 Ask your manager or dealer about the mode assigned to your PBX.
- \*2 Enter "#3" when "Plan 2" or "Plan 3" is selected as the numbering plan through system programming.
- **To return to the held call before the third party joins**, press the corresponding CO or INTERCOM button or press the Recall/hookswitch.
- By pressing the CO button corresponding to an outside (CO) line that is not being used by the conference, a proprietary telephone (PT) user can exit from the conference, leaving the other 2 parties connected unless they are both on outside (CO) lines. If the other parties are both on outside (CO) lines, they will be disconnected.

### ◆◆ Leaving a Conference Call (Unattended Conference)

The PT user who originated a conference with 2 outside parties can leave the conference and allow the other parties to continue the conversation. Certain extensions may be restricted from executing this feature through system programming.



### To leave a conference call and establish an unattended conference call

**PT**

*When you are talking with 2 outside parties*



Press **CONF**.

### To return while others are talking

**PT**



Press the **CO** flashing green at moderate speed.



- **CO-to-CO Line Call Duration**  
The length of outside-to-outside (CO-to-CO) line calls may be limited through system programming.  
Both outside parties will hear a warning tone 15 seconds before a specified time limit. When the timer expires, the call is disconnected.  
The originating extension user will hear a ring tone or an alarm tone before the time limit. If the originating extension does not return to the conference within a specified time period, the unattended conference call will be disconnected.

## ◆◆ Originating a 3-party to 5-party Conference Call (5-party Conference)

A PT user can establish a 3-party to 5-party conference call with up to 5 extensions or with a combination of extensions and up to 2 outside parties.



**To establish a 5-party conference call**

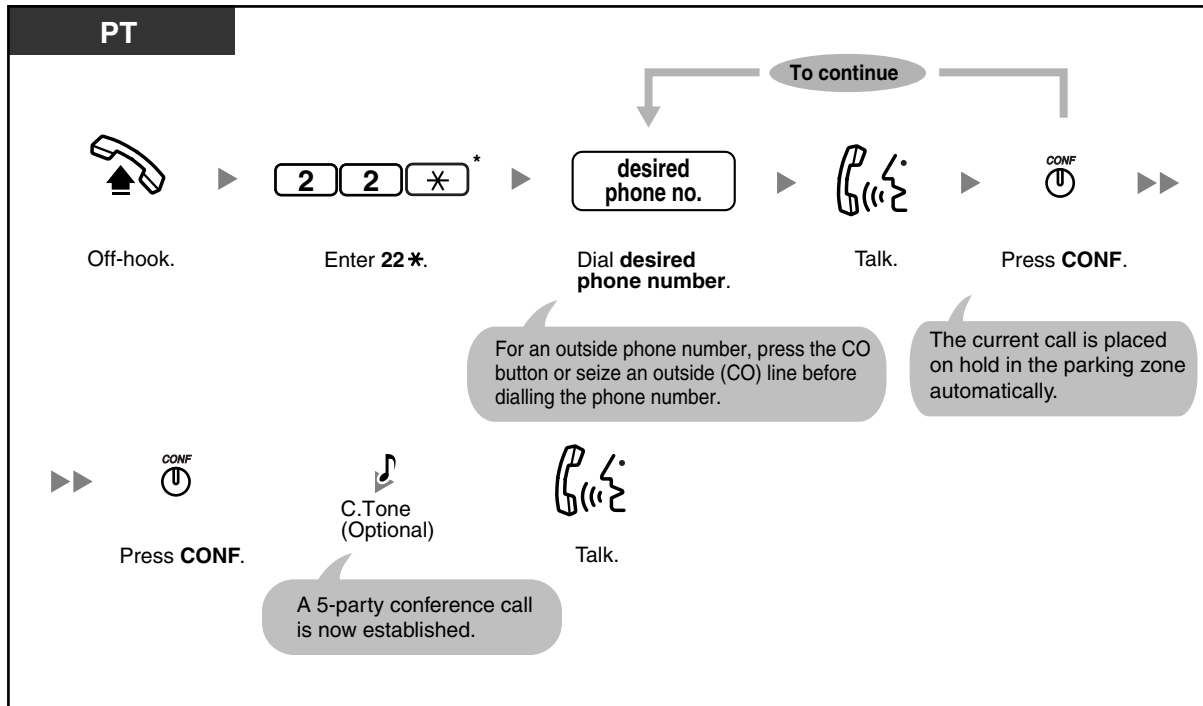

**To change to a 5-party conference call during a 3-party conference call with one or 2 outside parties**

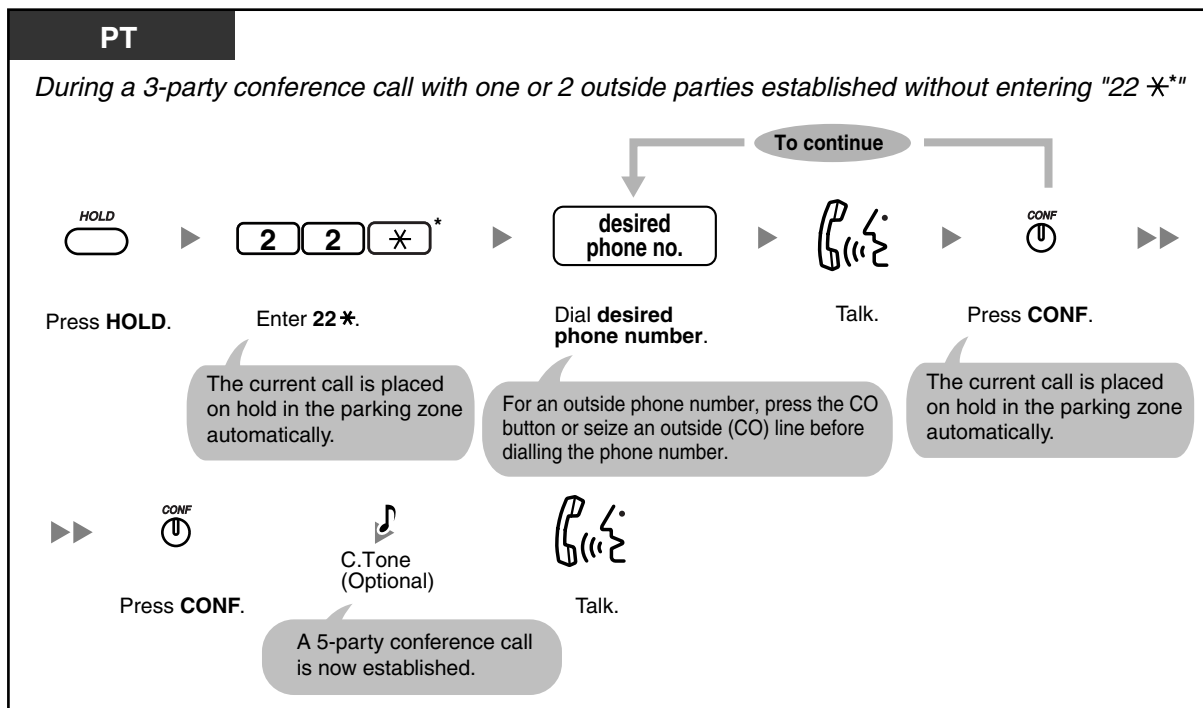

### To disconnect a 5-party conference call



- \* Enter "#22\*" when "Plan 2" or "Plan 3" is selected as the numbering plan through system programming.
- Only one 5-party conference call can be in progress at a time.
- You cannot change to a 5-party conference call during a 3-party conference call among 3 extensions.
- **If a parked call is not retrieved within 5 minutes while you are trying to establish a 5-party conference call**, you will hear a ring tone. If you are having a conversation with another party at that time, you will hear an alarm tone.
- **If you hear a busy tone after dialling the desired phone number or if you dial a wrong phone number**, press the FLASH/RECALL button to retry.
- **If you want to talk to the other 2 parties on hold again before the fourth party answers**, first go on-hook, then follow the Call Park Retrieve procedure and press the CONF button to retrieve each of the held calls.



#### Customising Your Phone

- 3.1.3 Customising the Buttons  
Create or edit a Conference button.

## 1.4.6 Muting a Microphone (Microphone Mute)

You can disable the microphone to consult privately with others in the room while listening to the other party on the phone through the speaker.



### To set/cancel



- The AUTO ANS/MUTE button light shows the current status as follows:
  - Off:** Normal
  - Flashing red slowly:** Mute
- This feature is only available during a hands-free conversation.

## 1.4.7 Using the Headset (Headset Operation)

Connecting an optional headset allows for hands-free conversations. This feature is also known as Handset/Headset Selection.



### To talk using the headset





## 1.4.8 Talking to Another Party without Lifting the Handset (Hands-free Operation)

You can have a conversation in hands-free mode using the SP-PHONE button.



### To switch from the handset to hands-free mode

**PT**

*During a conversation using the handset*



Press **SP-PHONE**.

▶



On-hook.

Do not go on-hook without pressing the SP-PHONE button first, or the call will be disconnected.

### To switch from hands-free mode to the handset

**PT**

*During a conversation in hands-free mode*



Off-hook.



- **Helpful hints for hands-free operation:**
  - **If it is difficult to hear the other party's voice:**  
Increase the volume using the Navigator Key or Volume Key.
  - **If the other party has difficulty hearing you:**  
Decrease the volume.
  - **If the other party reports that your voice echoes:**  
Use the telephone in a room that has curtains, carpeting or both.
  - **If parts of the conversation cannot be heard:**  
If you and the other party speak at the same time, parts of your conversation may be lost. To avoid this, try to speak alternately.

## 1.4.9 Changing the Dialling Mode (Pulse to Tone Conversion)

If you are using a pulse-type outside (CO) line, you can temporarily change the dialling mode from pulse to tone to access computer telephone services that require tone dialling such as Voice Mail.

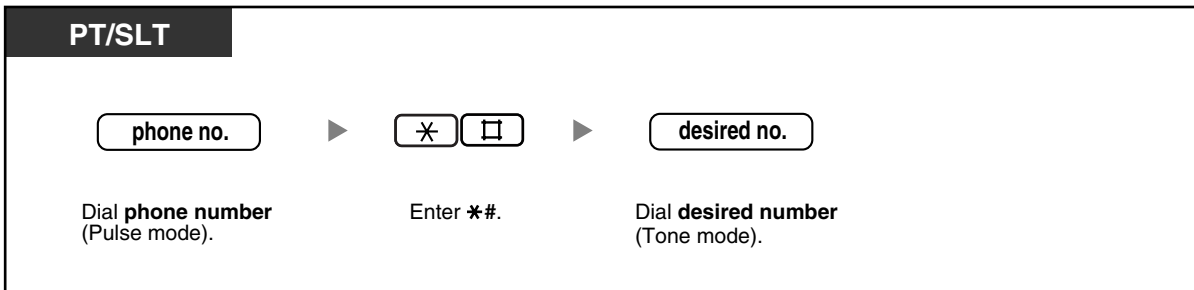

- You cannot change from tone to pulse dialling mode.
- This feature is not available for users in Australia.

## 1.5 Before Leaving Your Desk

### 1.5.1 Forwarding Your Calls (Call Forwarding [FWD])

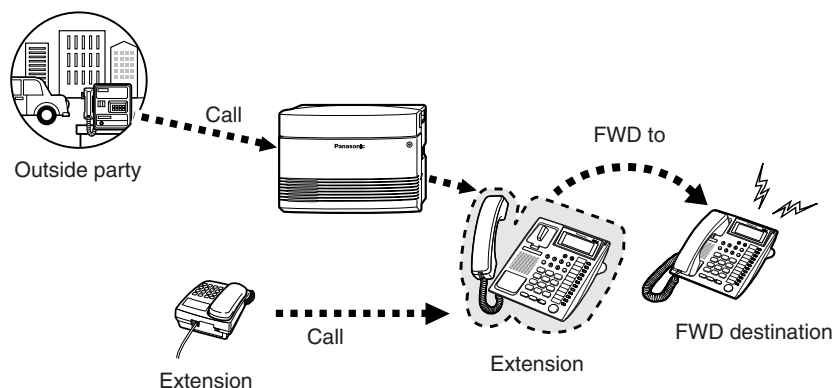

You can have your incoming calls forwarded to a specified destination. The following methods are available:

**All Calls:**

All calls are forwarded to a specified extension regardless of the status of your extension.

**Busy/No Answer (BSY/NA):**

All calls are forwarded to a specified extension when you do not answer within a specified time period or when your extension is busy.

**To Outside (CO) Line:**

All calls are forwarded to an outside party if your extension is permitted through system programming. The call duration is limited.

**Follow Me (From):**

If you fail to set the above-mentioned "All Calls" to forward before you leave your desk, you can set your calls to be forwarded from the destination extension.



- You can set the voice mail extension number as the Call Forwarding (FWD) destination to receive calls into your mailbox.
- You can set the Built-in Voice Message (BV) feature number as the FWD destination to receive calls into one of the voice message areas.
- The destination of an extension's forwarded calls can call or transfer calls to the original extension.

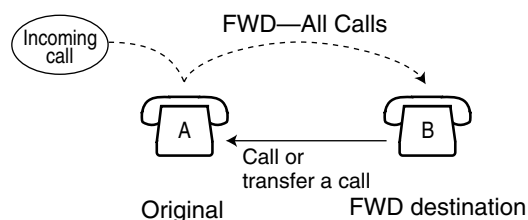

## 1.5 Before Leaving Your Desk

### To set/cancel

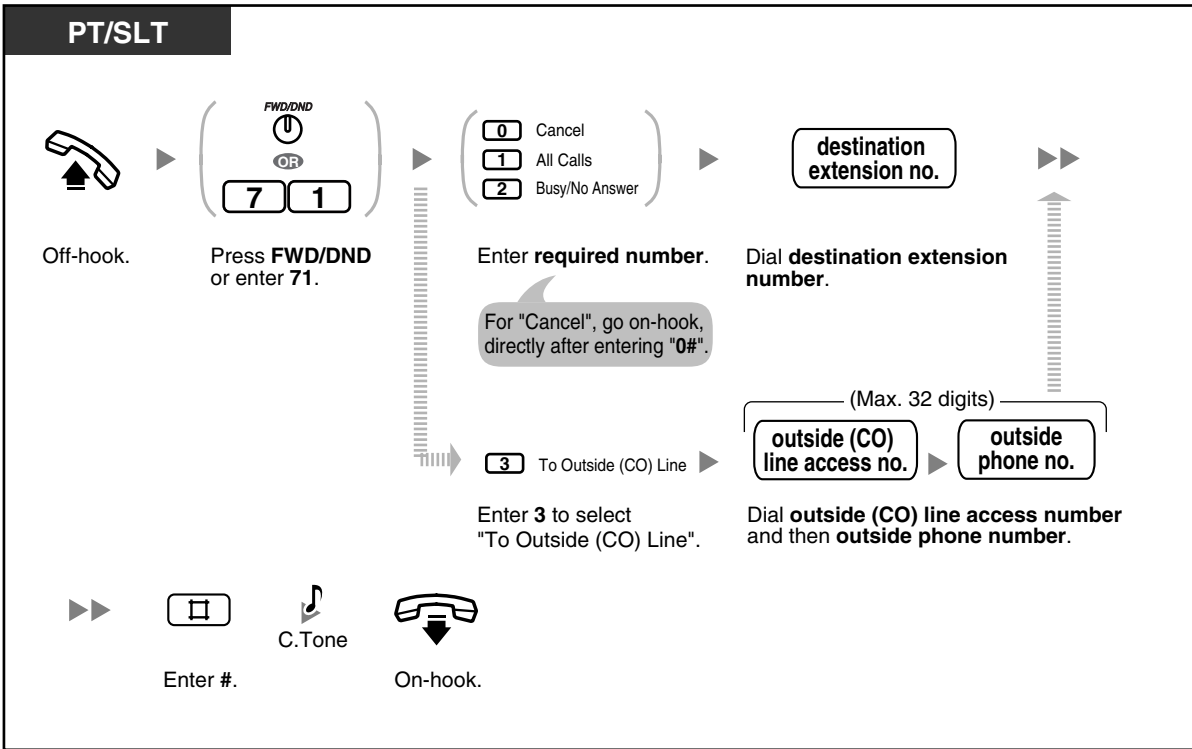

### To set/cancel from another extension

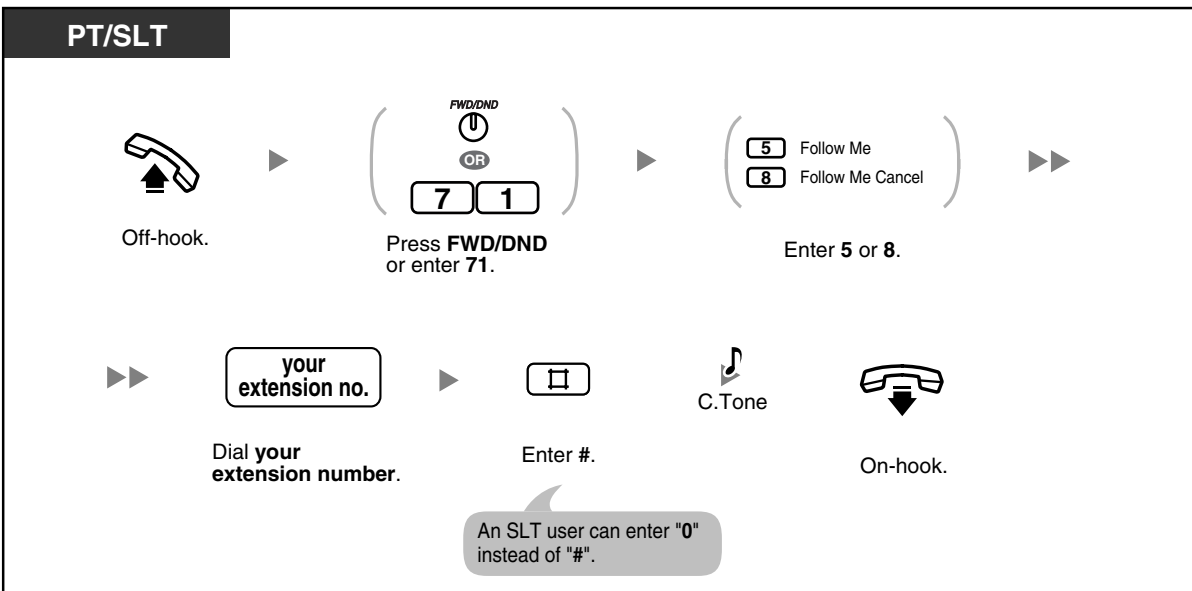



- The FWD/DND button light shows the current status as follows:
  - Off:** Neither feature is set.
  - Red on:** Do Not Disturb (DND) mode
  - Flashing red slowly:** FWD mode
- If a proprietary telephone (PT) user sets the FWD—Busy/No Answer feature, the FWD/DND button light will keep flashing while on-hook. To stop the button from flashing, go off-hook and enter "716#".
- A call can only be automatically forwarded one time. In the example below, extension A's calls are being forwarded to extension B. If extension B tries to set FWD to extension C, the extension B user hears a reorder tone and the setting is denied. If extension B has already set FWD to extension C, and extension A tries to set FWD to extension B, the setting is also denied.

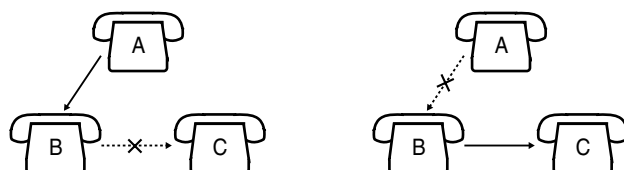

- You can confirm the current FWD destination by pressing the FWD/DND button while on-hook.
- CO-to-CO Line Call Duration**  
The length of outside-to-outside (CO-to-CO) line calls may be limited through system programming. Both the outside caller and the outside destination will hear a warning tone 15 seconds before a specified time limit. When the timer expires, the call is disconnected.



### Customising Your Phone

- 3.1.3 Customising the Buttons  
Create or edit an FWD/DND (Call Forwarding/Do Not Disturb).

## 1.5.2 Showing a Message on the Caller's Telephone Display (Absent Message)

If you are unable to answer calls, you can select a brief message that will be shown on the displays of Panasonic display proprietary telephone (PT) users when they call you. The message you select can explain the reason for your absence, and is also shown on the display of your PT every time you go off-hook.

Message no.	Message
1	Will Return Soon
2	Gone Home
3	At Ext %%% (Extension number)
4	Back at %:%% (Hour:Minute) AM (or PM)
5	Out Until %/%% (Month/Day)*
6	In a Meeting

### To set

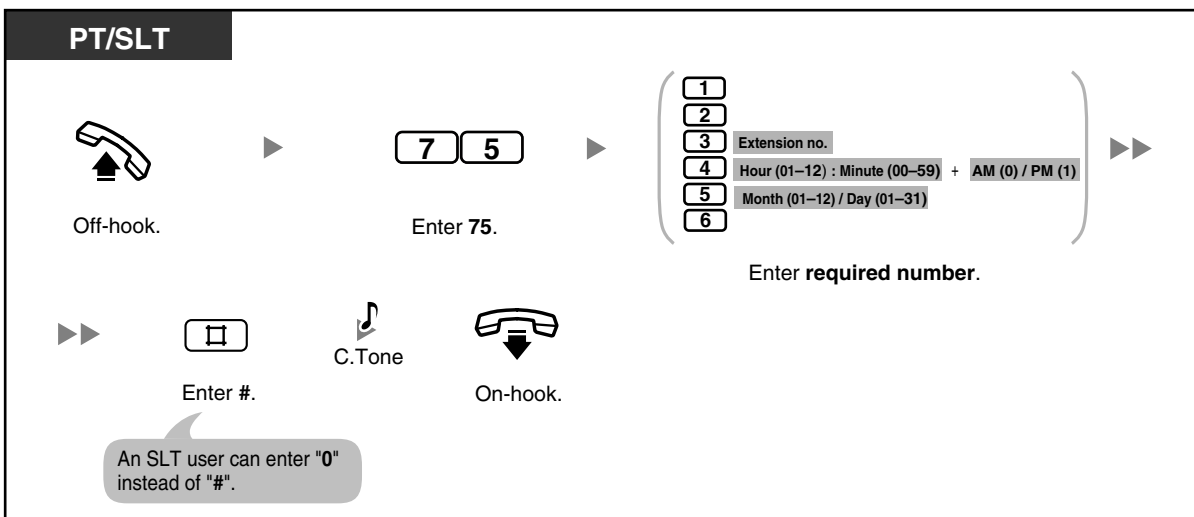

### To cancel

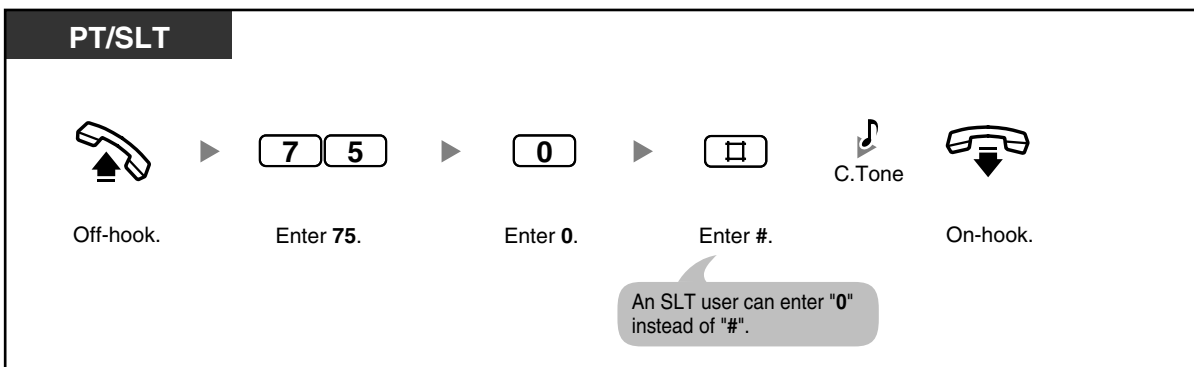

**To confirm**

- \* The date order varies depending on your country/area.
- Enter the desired value in the "%" positions. You must enter the number of digits represented by the number of "%" symbols.

### 1.5.3 Preventing Other People from Using Your Telephone (Extension Lock)

You can lock your extension so that outside (CO) line calls cannot be made. This can be useful to prevent other people from making inappropriate calls using your extension. This feature is also known as Electronic Station Lockout.

#### To lock/unlock

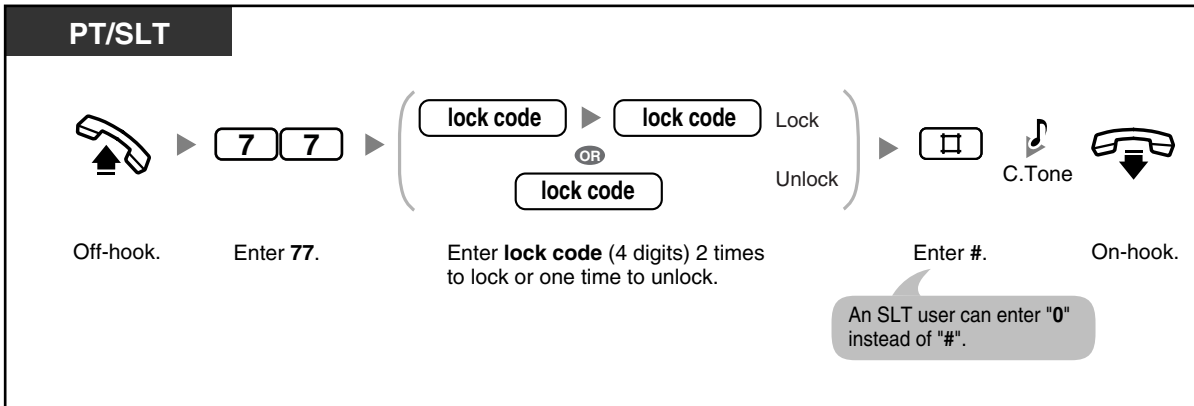

- If your extension is locked, it cannot be used to perform the following operations:
  - Making outside (CO) line calls
  - Accessing logged informationHowever, you may be able to make outside (CO) line calls depending on system programming.
- **If you forget the code or cannot unlock your phone**, ask your operator or manager. He or she can unlock your extension (Remote Extension Lock).
- The lock code must be 4 digits and must not include the "#" or "\*" characters.
- The operator or manager can cancel this feature for all extensions (Extension Lock—CANCEL ALL).
- This feature also functions as Incoming Call Log Display Lock.



## 1.5.4 Leaving a Group (Log-in/Log-out)

You can change your status in an extension group. When you log out, incoming calls to the group will not ring at your extension. When you log back in, calls will again ring at your extension. (Default: Log-in)

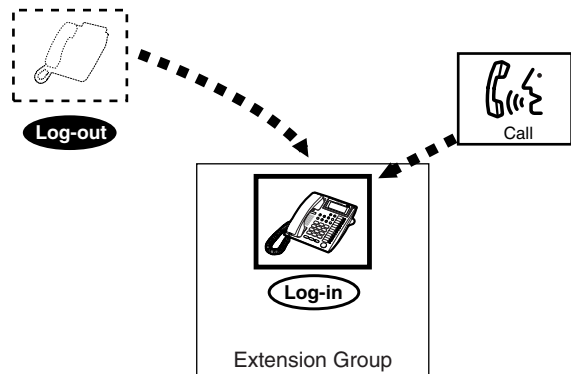

### To set Log-in/Log-out

**PT/SLT**

Off-hook.      Enter **736**.      Enter **0** to log-in or **1** to log-out.      Enter **#**.      C.Tone      On-hook.

An SLT user can enter "0" instead of "#".

**PT**

Off-hook.      Press **Log-in/Log-out**.      C.Tone      On-hook.

- The Log-in/Log-out button light shows the current status as follows:  
**Off:** Log-in mode  
**Red on:** Log-out mode
- The last member of a group cannot log out.

### Customising Your Phone

- 3.1.3 Customising the Buttons  
 Create or edit a Log-in/Log-out button.

## 1.5.5 Using Voice Messaging (Built-in Voice Message [BV])

- Recording, Playing, or Erasing Personal BV Outgoing Messages
- Forwarding Your Calls to Built-in Voice Message
- Leaving, Playing, or Erasing Voice Messages

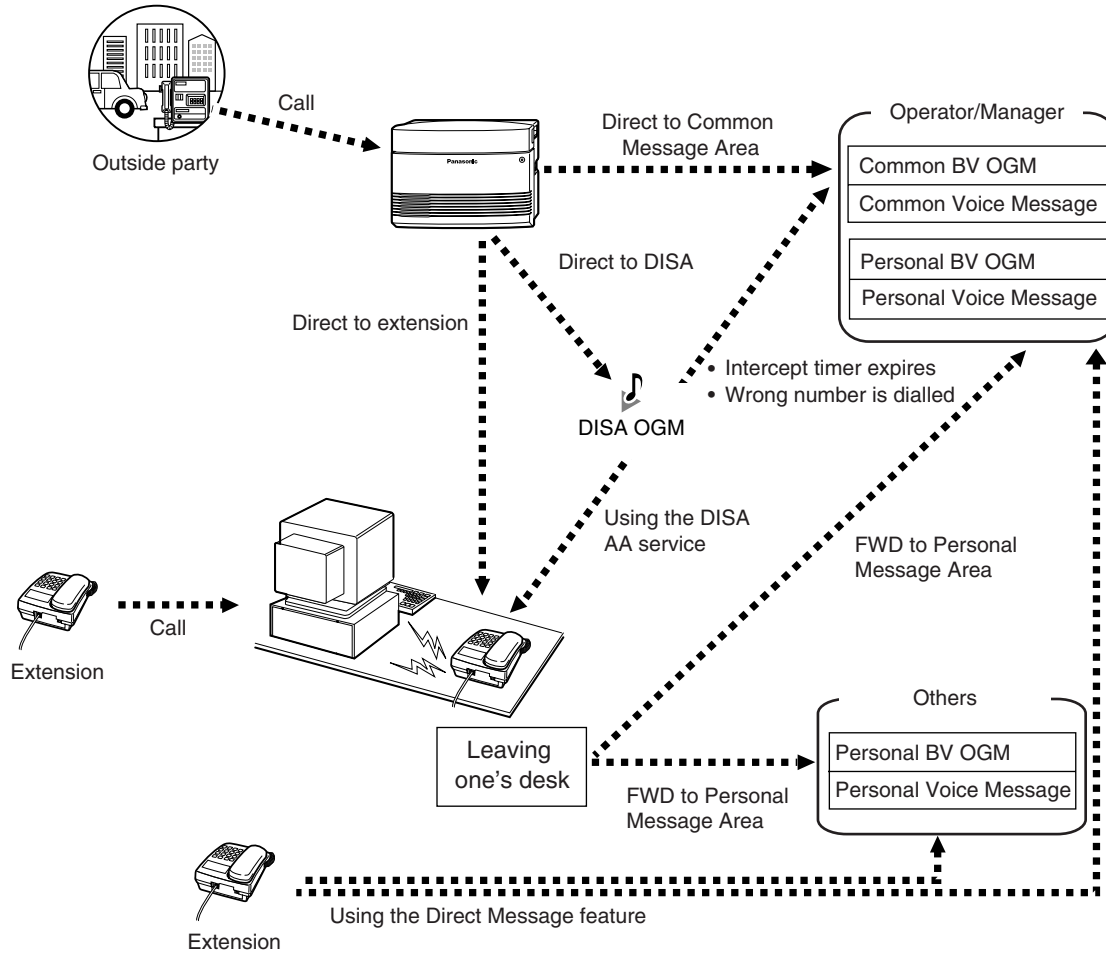

If an optional voice message card is installed in the PBX, a caller can leave a voice message in one of the voice message areas. There are 2 types of voice message area: personal message area and common message area.

A personal message area is where callers can leave messages directly for you. When an incoming call (a call direct to your extension, or a call using the Direct Inward System Access [DISA] Automated Attendant [AA] service) is forwarded to your personal message area, the caller will hear a personal Built-in Voice Message (BV) outgoing message (OGM) and can leave a voice message. You can access your personal message area to play back or erase caller messages.

A common message area is where callers can leave messages for the company. When an outside (CO) line call is automatically directed to the common message area, or when a DISA call is redirected to the common message area via Intercept Routing, the caller will hear a common BV OGM and can leave a voice message. Only the operator or manager can access the common message area to play back or erase caller messages.

If there are new voice messages in your personal message area or the common message area (if accessible), you will hear dial tone 4 when going off-hook. Additionally, if your telephone has a MESSAGE

button or Message/Ringer Lamp, the corresponding button or lamp turns on when a message has been left. You can also perform the following operations:

- You can record, play, or erase a personal BV OGM for your personal message area.
- The operator or manager can record, play, or erase a common BV OGM for the common message area. Refer to "2.1.6 Recording, Playing, or Erasing Common BV Outgoing Messages".
- You can set incoming calls to be forwarded to your personal message area, when you cannot answer them.
- You can leave a voice message in the personal message area of another extension, even if the extension has not been set to forward incoming calls to its personal message area, or even if no personal BV OGM has been recorded (Direct Message).  
When a caller leaves a voice message using the Direct Message feature, the voice message is automatically linked to the caller information (including the extension number and name [if stored]) in the Incoming Call Log.
- You can access the personal/common message area from an outside telephone by using a preprogrammed voice message access code. The code to enter differs depending on whether you are calling directly to an extension (that is forwarded to the extension's message area) or to the common message area, or you are calling with DISA.

**Call Log**

When viewing caller information, you can see whether the caller left a voice message. For more details, refer to "1.9.1 Calling with the Incoming Call Log".

**Notes**

- If you set the Voice Mail Integration feature, the BV feature will not function.
- When another extension user is recording or erasing a personal/common BV OGM, you cannot perform any operations using the BV feature. When another extension user or an outside caller is performing operations other than those mentioned above, you may not be able to use the BV feature. In this case, wait a few minutes and try again.

◆◆ **Recording, Playing, or Erasing Personal BV Outgoing Messages**

**To record**

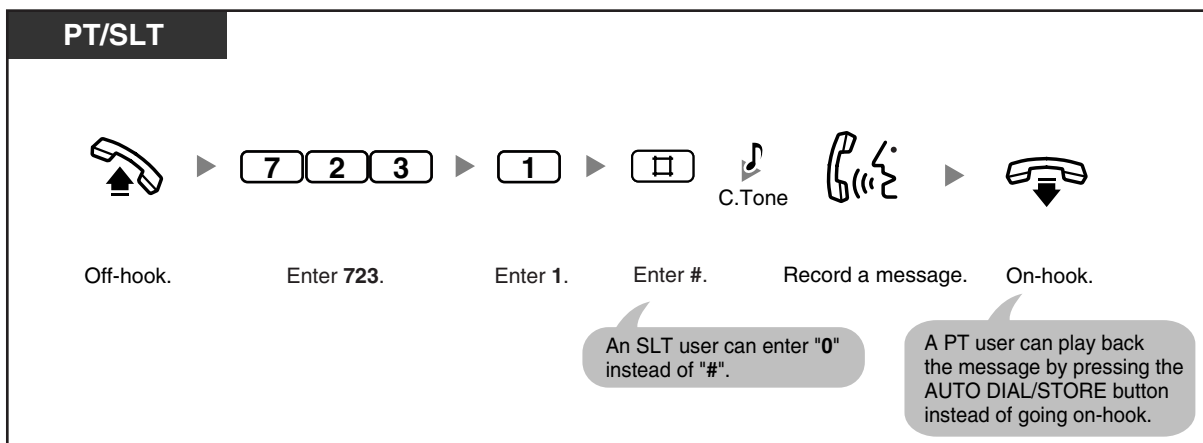

### To play back

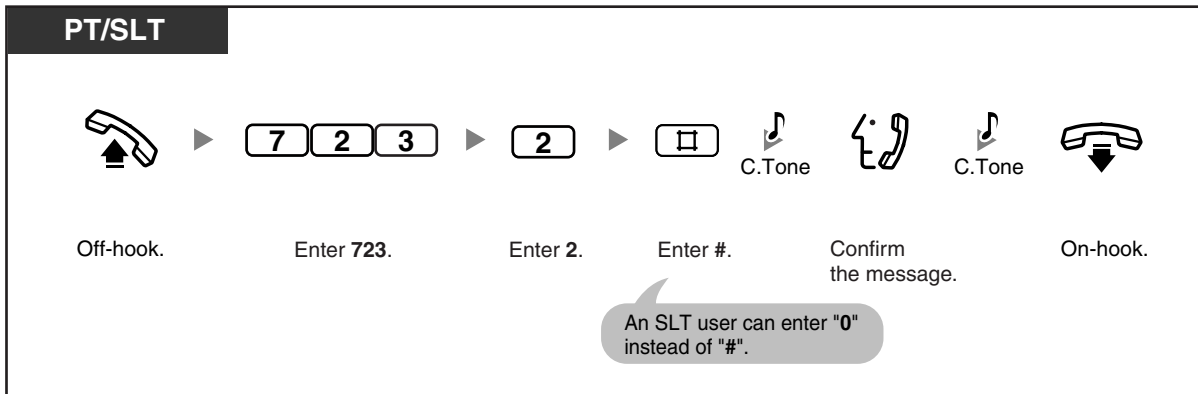

### To erase

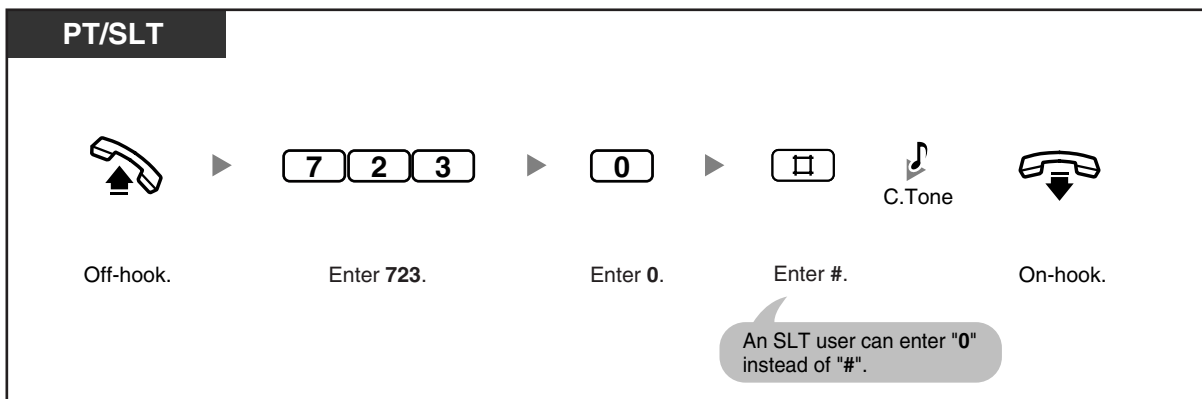

- The AUTO DIAL/STORE button light shows the current status as follows:  
**Off:** You are recording a message, or a message has finished playing.  
**Red on:** A message is playing.
- You can stop playback by pressing the AUTO DIAL/STORE button.

## ◆◆ Forwarding Your Calls to Built-in Voice Message

### To set/cancel

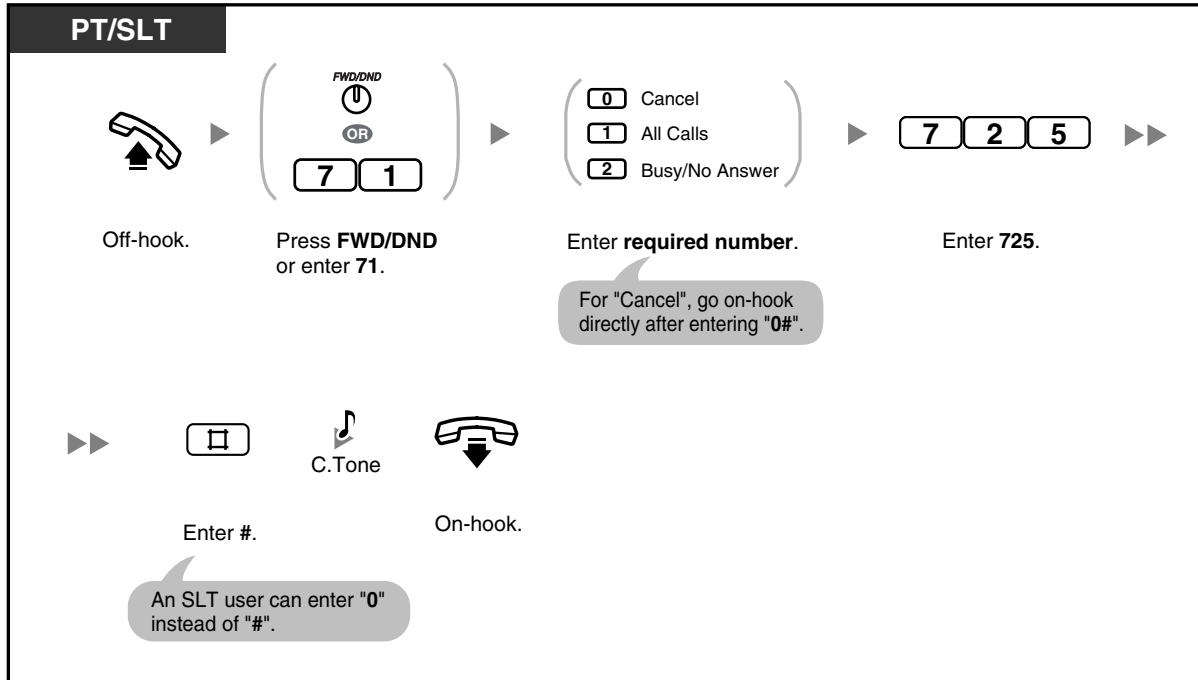

- Setting this feature also cancels other types of Call Forwarding (FWD)/Do Not Disturb (DND).



### Customising Your Phone

- 3.1.3 Customising the Buttons  
Create or edit an FWD/DND (Call Forwarding/Do Not Disturb).

## ◆◆ Leaving, Playing, or Erasing Voice Messages

To leave a voice message in a user's personal message area

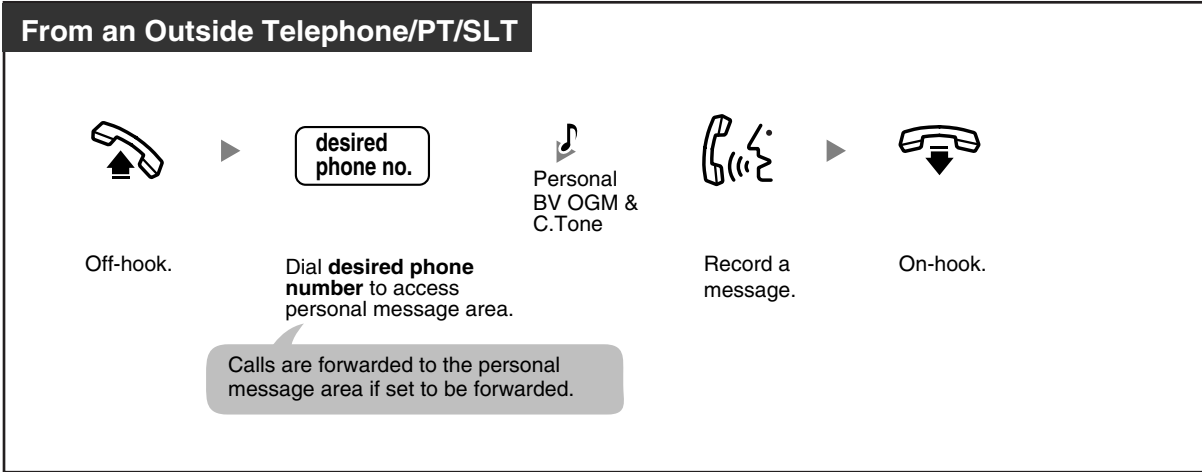

To leave a voice message in the common message area

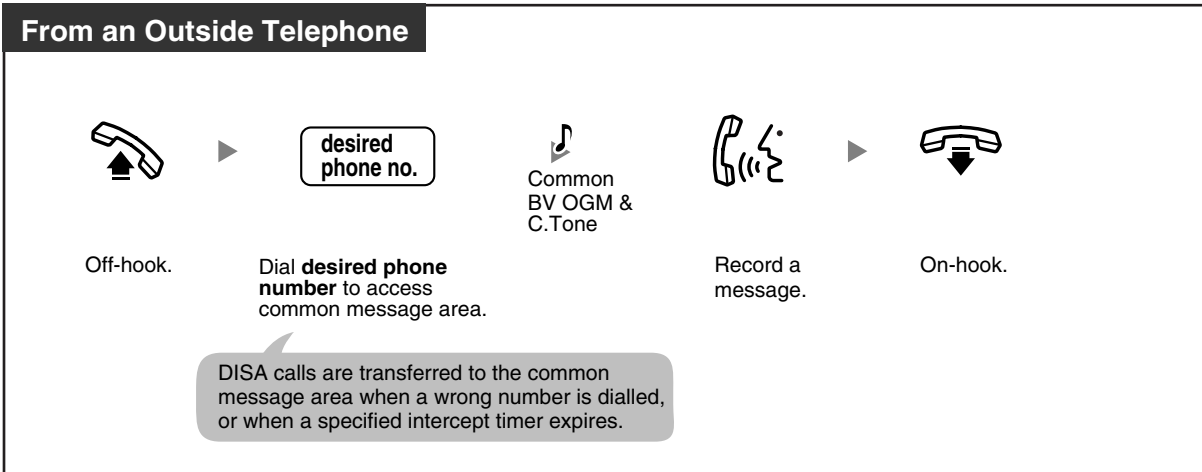

**To leave a voice message using Direct Message**

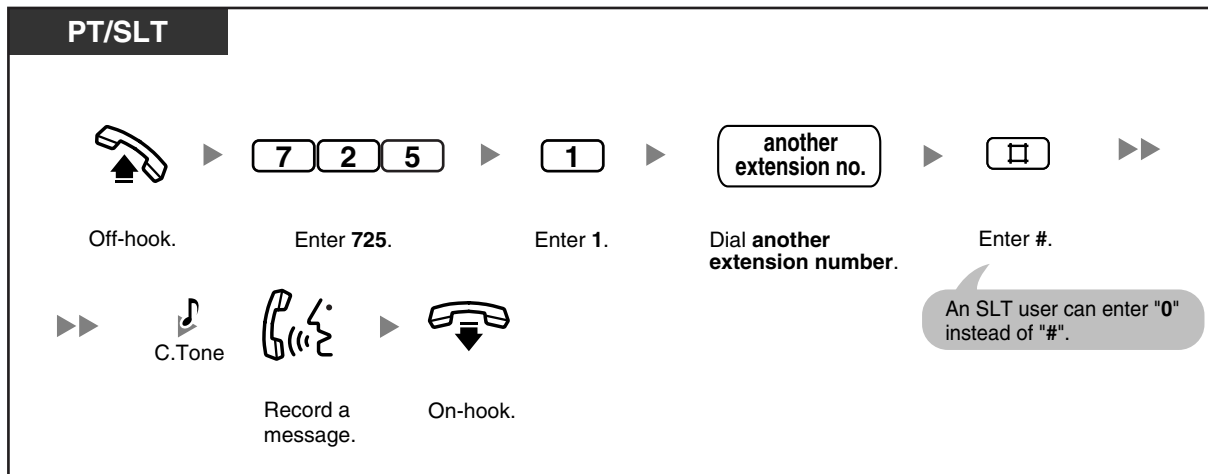

**To view and play back a voice message in a voice message area**

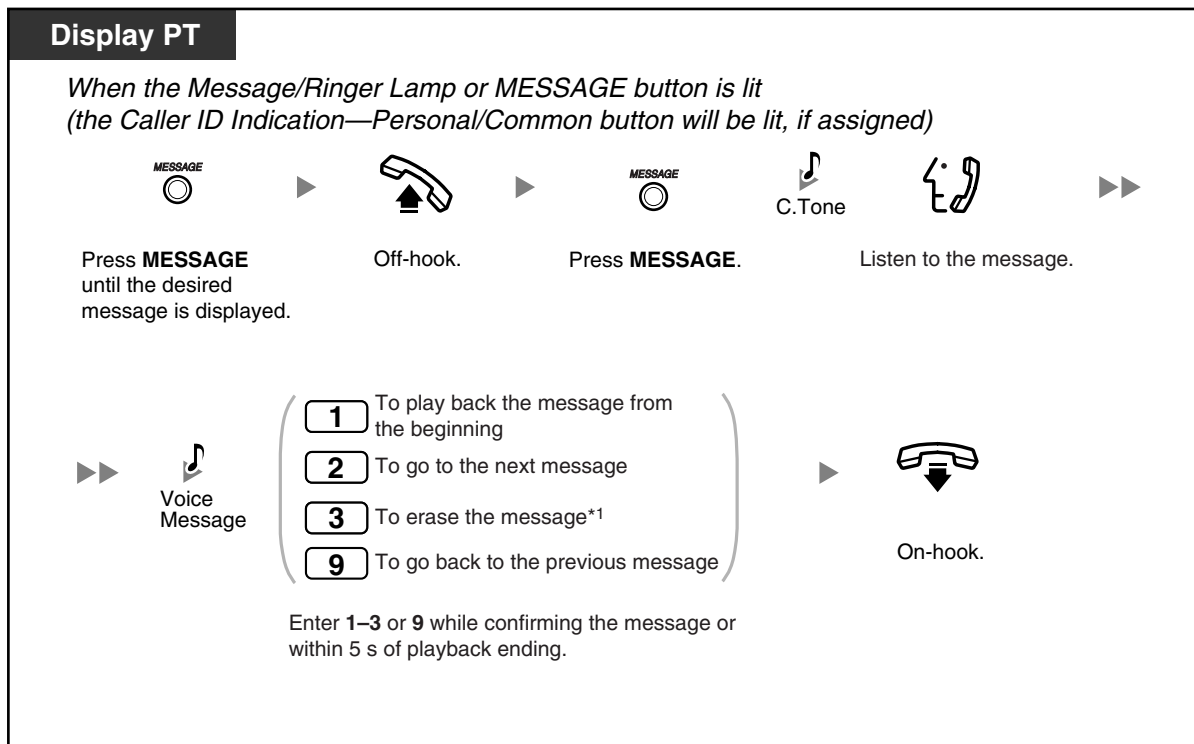

**To play back all voice messages in a voice message area**

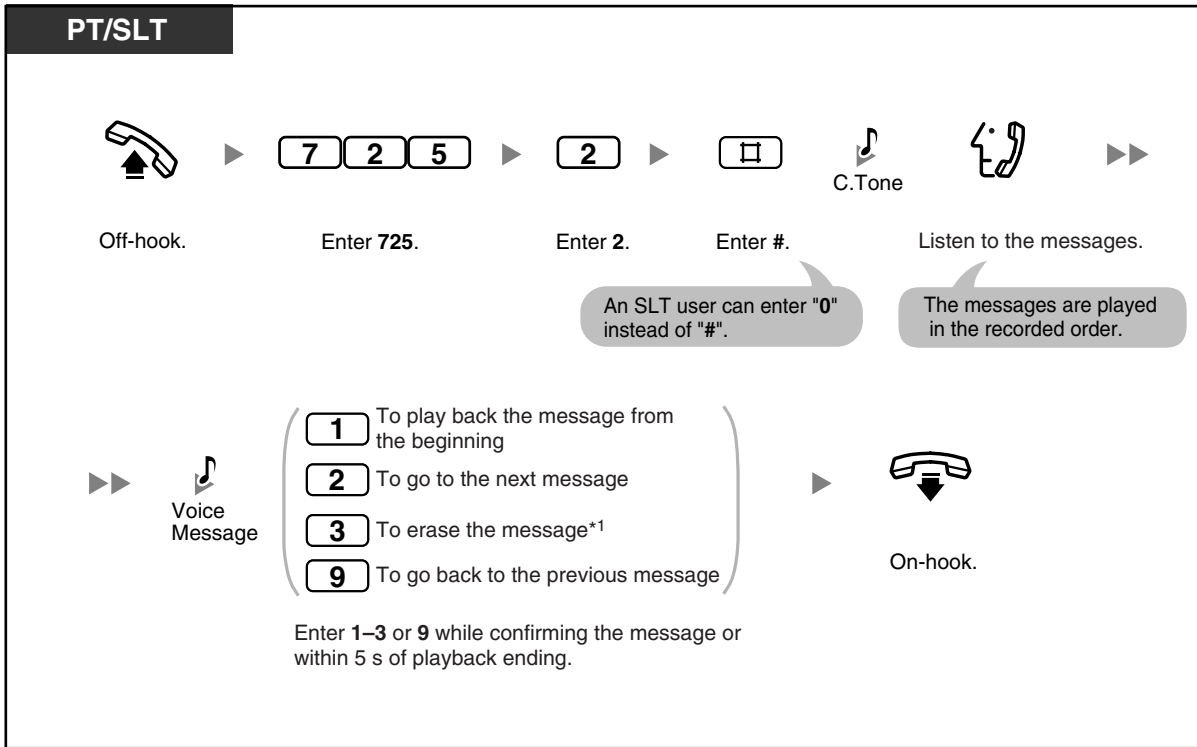

**To erase all voice messages in a voice message area**

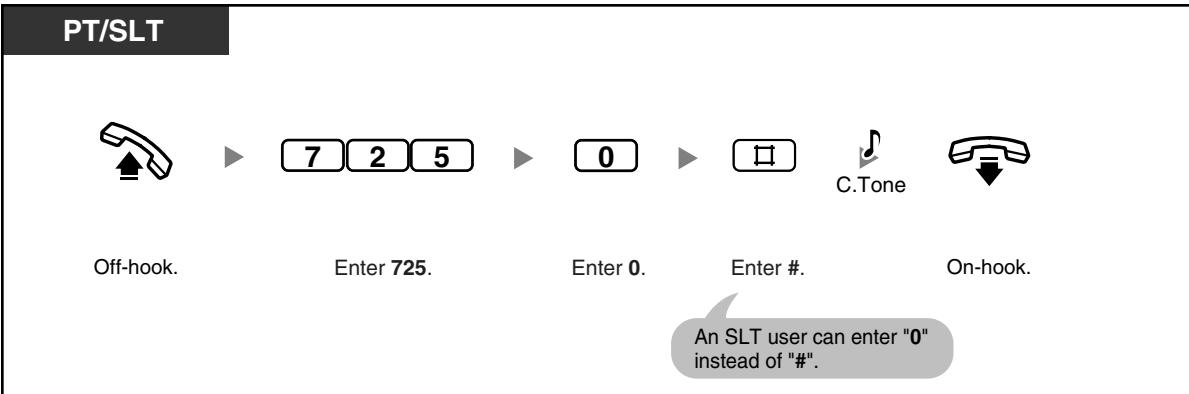



## To play back and/or erase voice messages from an outside telephone

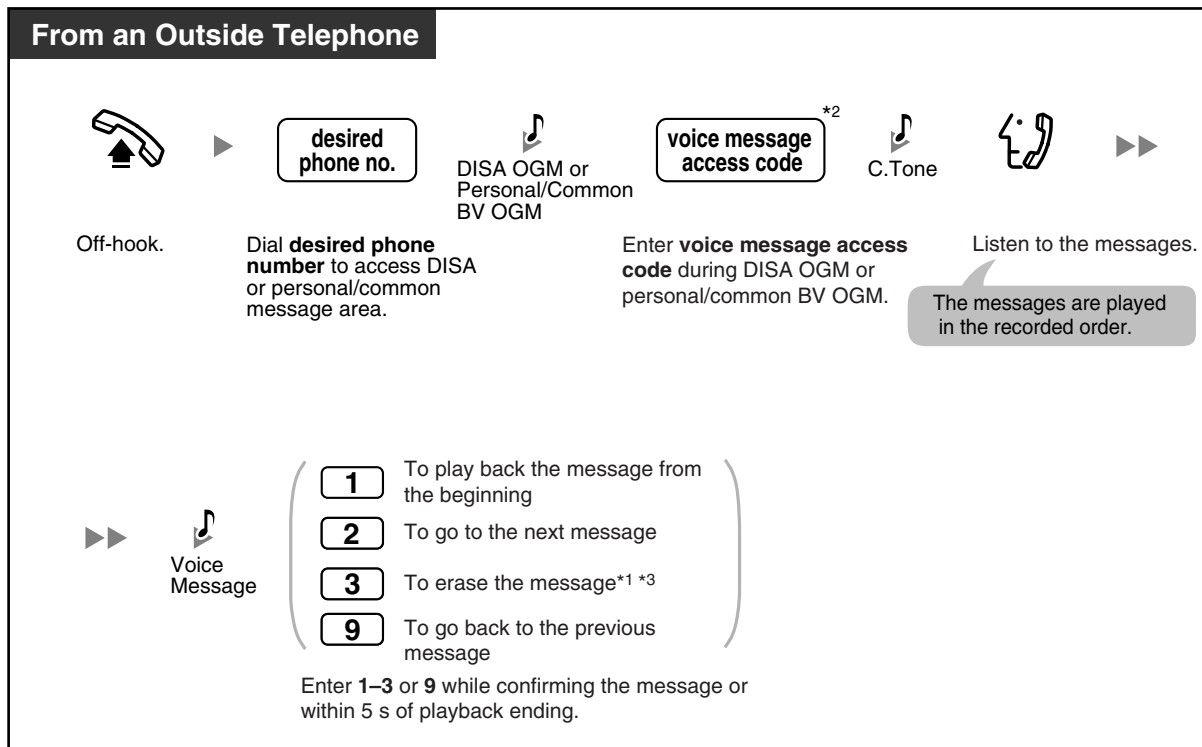

- \*1 To erase a voice message while listening to the message, enter "3". You will hear dial tone 3. Enter "3" again to erase the message. If you change your mind and decide not to erase the message, dial another number ("1", "2", or "9") or go on-hook while hearing dial tone 3.
- \*2 For a directed call to an extension (forwarded to the extension's message area), that extension's voice message access code must be entered. While hearing the common BV OGM, the operator/manager's voice message access code must be entered.
- \*3 When you are calling from an outside telephone, after hearing dial tone 3 for 5 seconds, the next message is automatically played back. You can dial any function number ("1", "2", "3", or "9") while confirming any message.

## 1.5 Before Leaving Your Desk



- Callers cannot put a call on hold by pressing the TRANSFER or HOLD button while recording a voice message.
- If you enter a wrong voice message access code, when trying to play back voice messages from an outside telephone, the call will be disconnected after 10 seconds. When playback is complete, or you have no voice messages recorded, the call will be disconnected after 5 seconds.
- When you erase voice messages, the caller's information is erased simultaneously.
- The MESSAGE button light or Message/Ringer Lamp shows the current status of the voice message area as follows:  
**Off:** No voice messages, or old voice messages only  
**Red on:** New voice messages  
If your telephone has no MESSAGE button or Message/Ringer Lamp, you cannot tell by looking whether there are new voice messages.
- If a new voice message has been recorded, you will hear dial tone 4 when going off-hook.

### Dial Tone 4



- When the remaining recording time for the PBX is less than 5 minutes or when 125 voice messages have been recorded, the display informs you that the voice message area is full, and you hear dial tone 5 when going off-hook. If the remaining recording time goes back to being 5 minutes or more, for example, when messages are erased, the display returns to the idle status display and you will hear another dial tone instead of dial tone 5 when going off-hook.

### Dial Tone 5

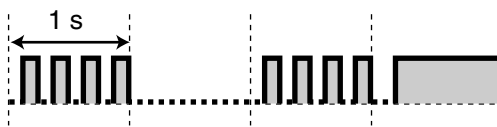

- A proprietary telephone (PT) user can listen to voice messages by entering the Message Waiting Answer feature number, "784# (7840)".



## Customising Your Phone

- 3.1.3 Customising the Buttons  
Create or edit a Message button, Caller ID Indication—Personal button, or Caller ID Indication—Common button.

## 1.6 Making/Answering a Paging Announcement

### 1.6.1 Paging

- Paging
- Paging and then Transferring a Call

#### ◆◆ Paging

You can make a paging announcement to several people at once. Your paging announcement can be heard through an external speaker and through the built-in speakers of proprietary telephones (PTs). An extension user can answer your paging announcement and establish an intercom call. There are 4 types of paging as shown below:

**All Extensions:**

Paging through the built-in speakers of all PTs.

**Group:**

Paging to a certain extension group through the built-in speakers of PTs.

**External:**

Paging through an external speaker.

**All Extensions & External:**

Paging through both the built-in speakers of all PTs and an external speaker.

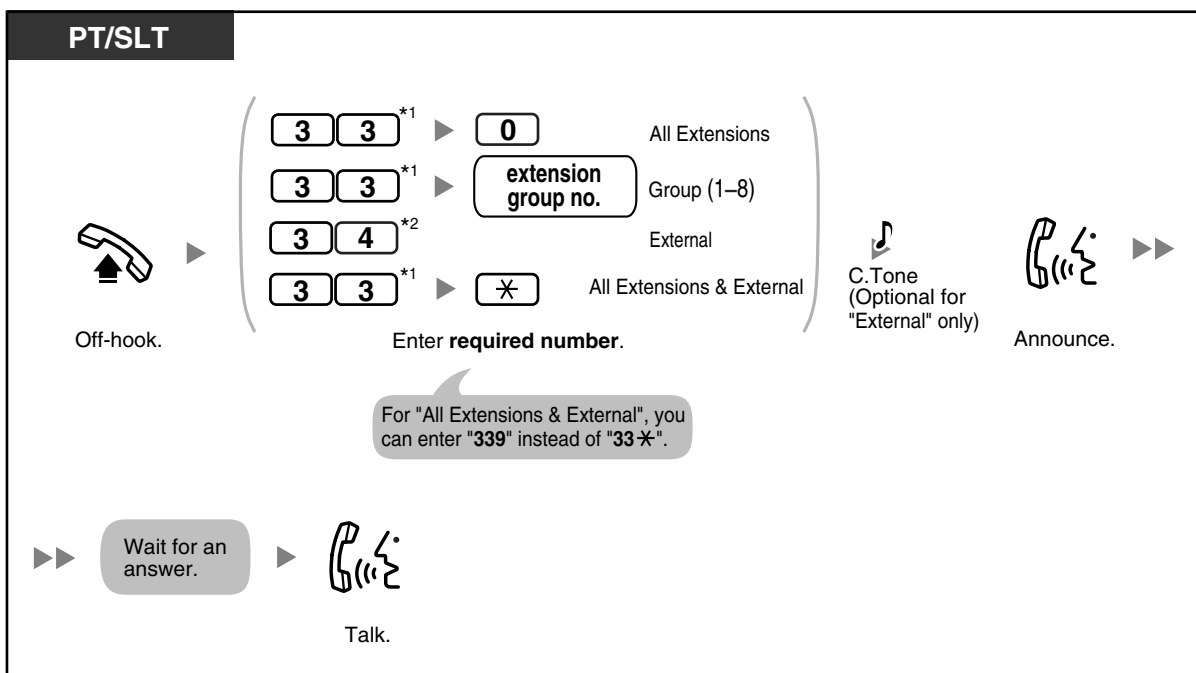

- \*1 Enter "#33" when "Plan 2" or "Plan 3" is selected as the numbering plan through system programming.
- \*2 Enter "#34" when "Plan 2" or "Plan 3" is selected as the numbering plan through system programming.
- Only one person can use the Paging feature at a time. If someone is already using the Paging feature when you try to make a paging announcement, you will hear a busy tone.

## ◆◆ Paging and then Transferring a Call

You can transfer a call after making a paging announcement.

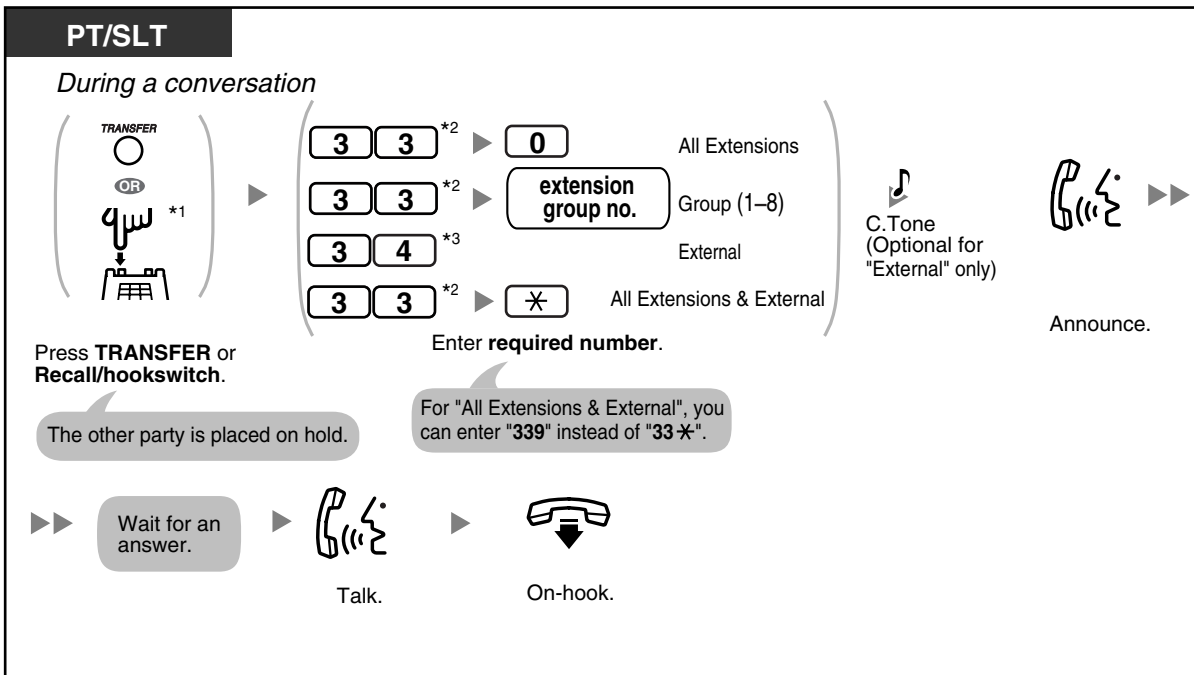

- 
  - \*1 You may have to enter the Call Hold feature number after pressing the Recall/hookswitch on your single line telephone (SLT), depending on the SLT Hold Mode of your PBX.  
Call Hold feature number:
    - Plan 1: 20 (United Kingdom/New Zealand: 50)
    - Plan 2/Plan 3: #20 (United Kingdom/New Zealand: #50)
 Ask your manager or dealer about the mode assigned to your PBX.
  - \*2 Enter "#33" when "Plan 2" or "Plan 3" is selected as the numbering plan through system programming.
  - \*3 Enter "#34" when "Plan 2" or "Plan 3" is selected as the numbering plan through system programming.
  - After you go on-hook, the party on hold can talk to the person who answers the page.

## 1.6.2 Answering/Denying a Paging Announcement

You can answer a paging announcement from any extension. You can also set your proprietary telephone (PT) to not receive paging announcements.

### To answer

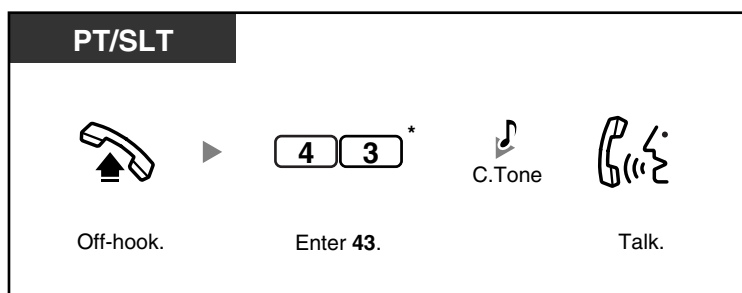

### To refuse/accept paging announcements (Paging Deny)

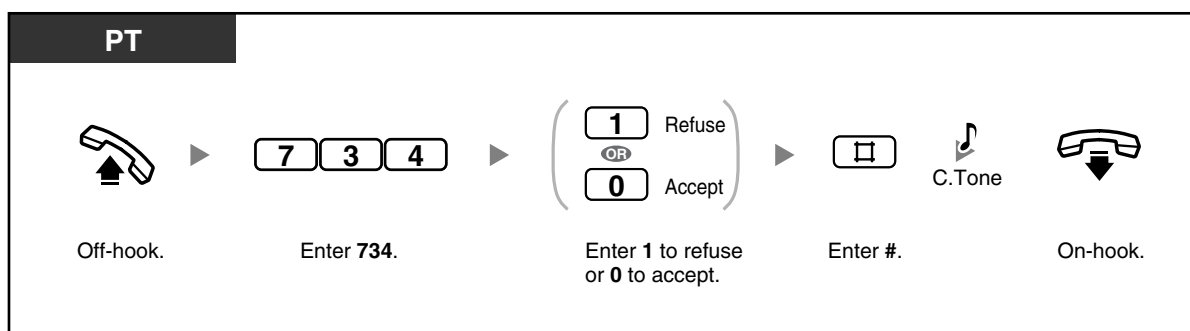

- \* Enter "#43" when "Plan 2" or "Plan 3" is selected as the numbering plan through system programming.
- When an outside (CO) line call is paged and transferred, you can answer the call by pressing the corresponding CO button whose indicator is flashing slowly.
- The following are extensions that cannot receive paging announcements:
  - a PT that is ringing or busy
  - a PT in Paging Deny mode
  - a PT in Do Not Disturb (DND) mode

# 1.7 Setting the Telephone According to Your Needs

## 1.7.1 Setting the Alarm (Timed Reminder)

You can set your telephone to ring at a set time, to remind you of a meeting, appointment, or as a wake-up call. The alarm can occur either one time or daily (every day until cancelled) at a preset time. When you go off-hook to answer, you hear a special dial tone (dial tone 3).

### To set

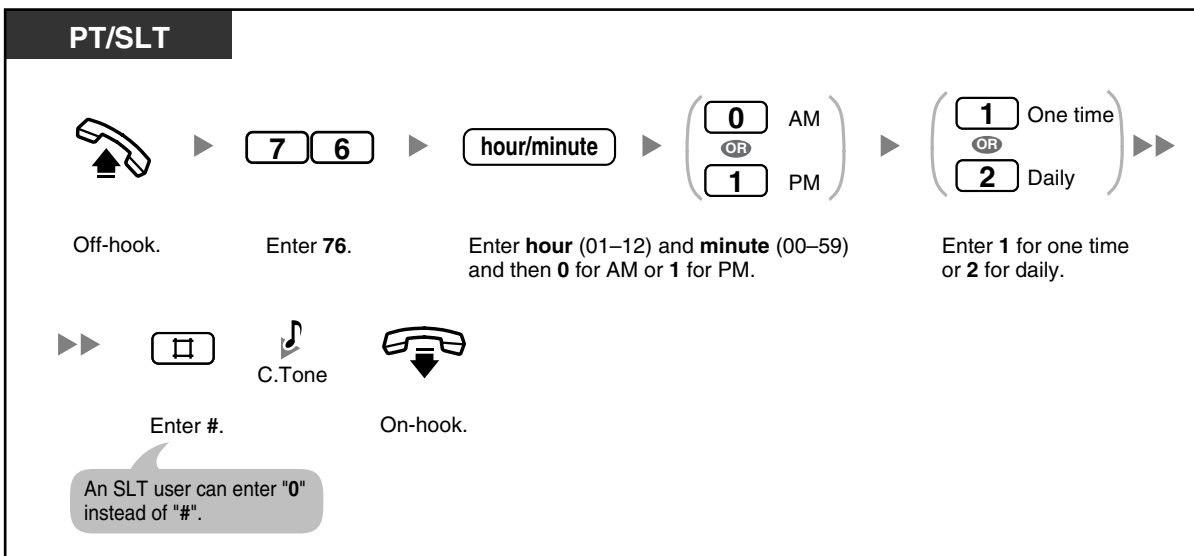

### To cancel

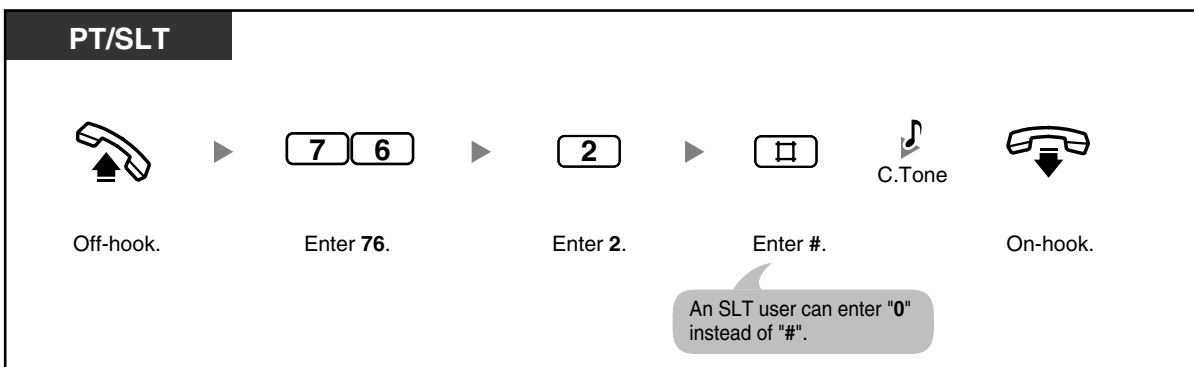

## To stop the alarm

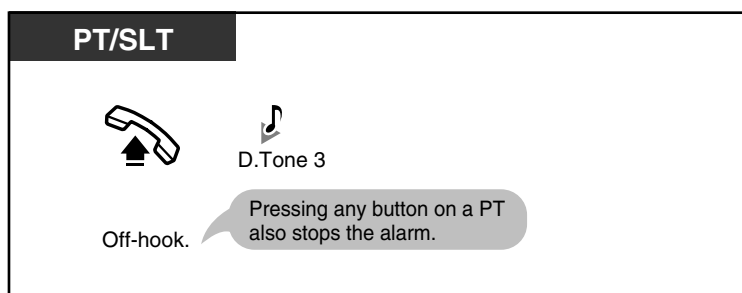

## To confirm

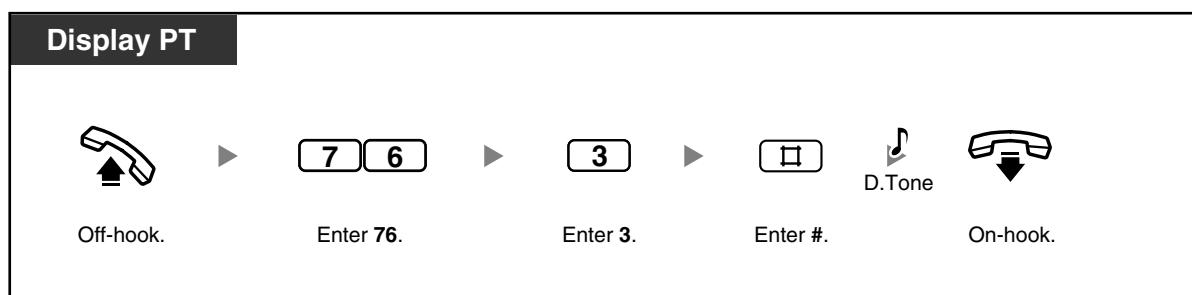

- The alarm rings for 30 seconds.
- **If you receive an incoming call during an alarm**, the ringing for that call will start after the alarm stops ringing.
- If the telephone is off-hook at the time an alarm is scheduled to ring, the alarm will start after the telephone goes on-hook again.

## 1.7.2 Refusing Incoming Calls (Do Not Disturb [DND])

You can set your telephone to prevent incoming calls from ringing at your telephone. This can be useful in situations where you do not want to be disturbed, for example during a meeting.

### To set/cancel

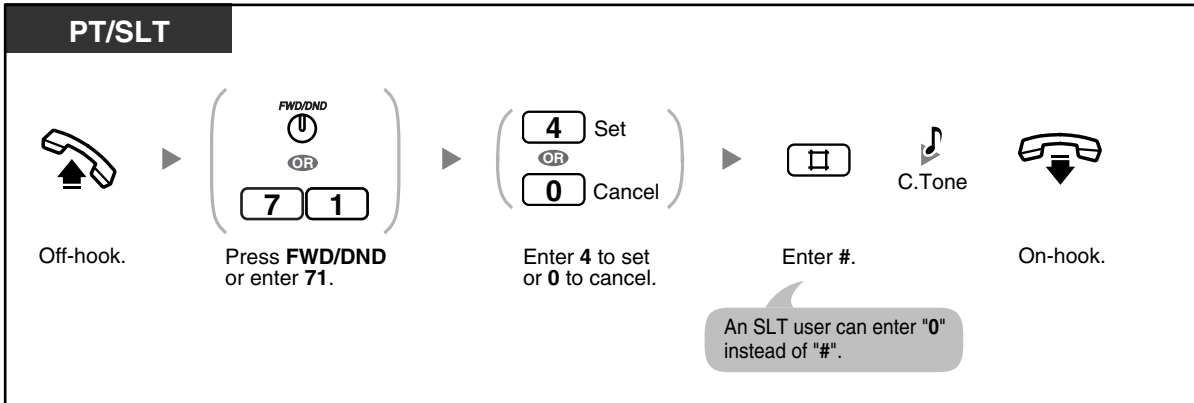

- The FWD/DND (Call Forwarding/Do Not Disturb) button light shows the current status as follows:
  - Off:** Neither feature is set.
  - Red on:** DND mode
  - Flashing red slowly:** FWD mode
- If your extension has set this feature, calling extensions will hear a DND tone.
- If this feature is set, the FWD feature does not function.
- Extensions can override this feature and call extensions in DND mode (DND Override) if they are allowed to do so through system programming.
- Outside (CO) line calls can be received at your extension, but the telephone will not ring. The corresponding CO button will flash when an outside (CO) line call is received, and you can answer the call by pressing this button.
- Even if this feature is set, timed reminder alarms, camp-on recall tone, and hold recall tones (ring tones or alarm tones) will still ring.



### Customising Your Phone

- 3.1.3 Customising the Buttons
  - Create or edit an FWD/DND (Call Forwarding/Do Not Disturb) button.



### 1.7.3 Receiving Call Waiting

During a conversation, you can be informed of a waiting call by a tone through the built-in speaker of your proprietary telephone (PT) or the handset of your single line telephone (SLT) (Default: Disable). To change the call waiting tone using your PT, refer to "3.1.2 Changing Personal Settings Using Programming Mode". To answer a waiting call, refer to "1.4.4 Answering Call Waiting".

#### To set/cancel for outside (CO) line calls

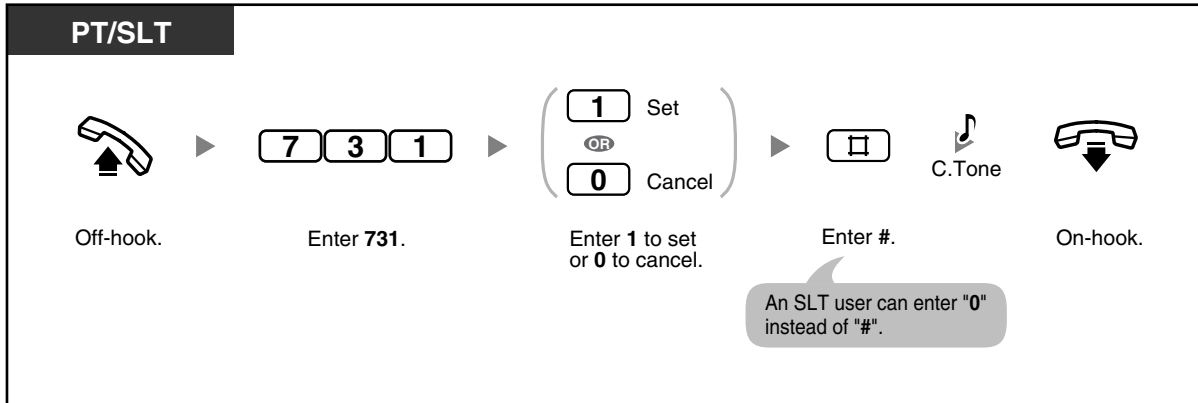

#### To set/cancel for intercom/doorphone calls

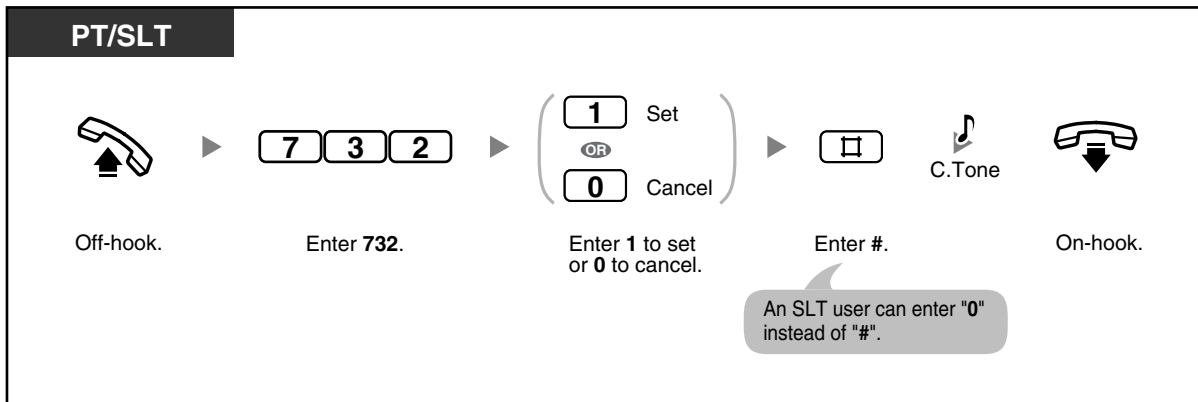

## 1.7.4 Preventing Other People from Joining Your Conversation (Executive Busy Override Deny)

You can prevent other extension users from using the Executive Busy Override feature to join an ongoing call.

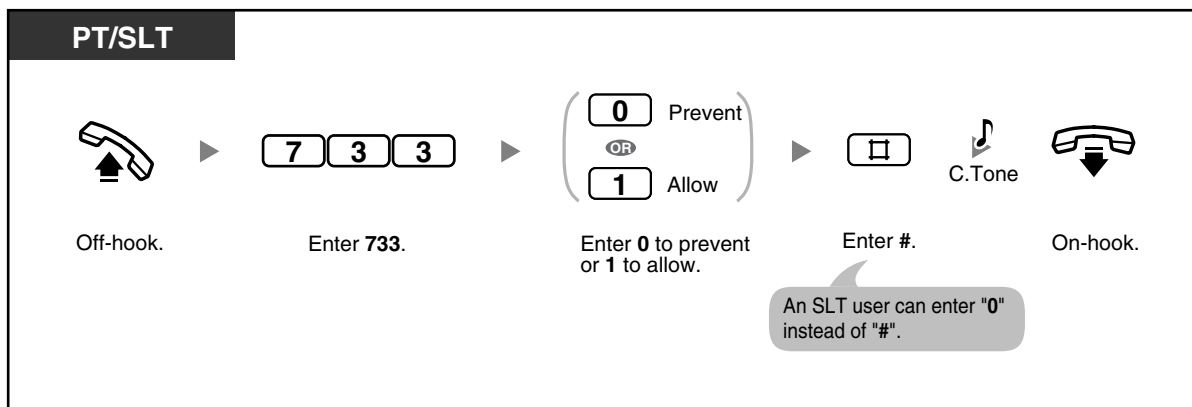

## 1.7.5 Turning on the Background Music (BGM)

You can listen to background music (BGM) through your telephone speaker while on-hook. If your extension becomes busy (off-hook, making or receiving a call etc.), the music will stop. When you go back on-hook, the music starts again.



No SLT

### To set/cancel

PT
<i>While on-hook</i>
<input type="text" value="1"/>
Enter 1.



- Your PBX can be programmed not to play music when "1" is entered while on-hook. Ask your manager or dealer.

## 1.7.6 Protecting Your Line against Notification Tones (Data Line Security)

You can protect the line against audible notification tones, such as call waiting tones or hold alarm tones during a conversation. Set this feature if your extension has a data communication device such as a computer or fax machine connected, to ensure secure data transmission.

### To set/cancel

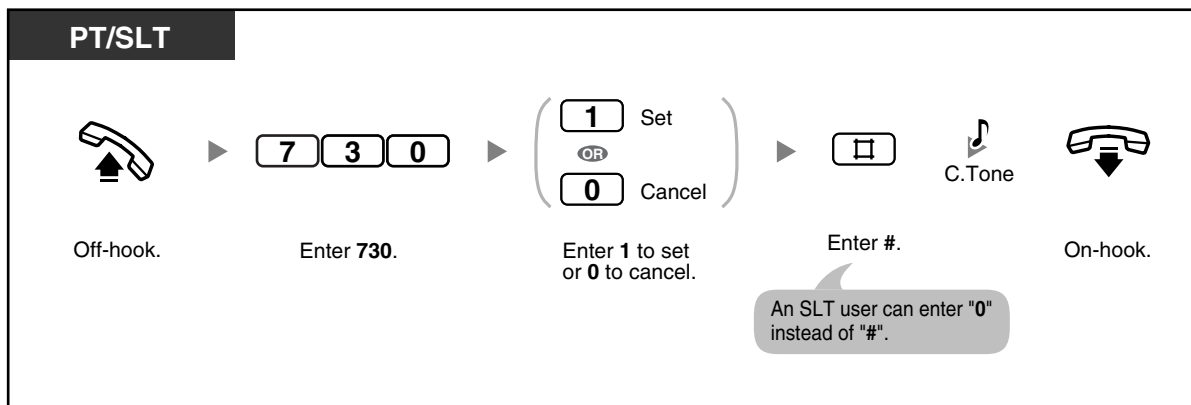

## 1.7.7 Checking the Time Service Mode

The PBX can be programmed to make and receive calls differently in day/night/lunch modes. You can confirm the current time service mode (day, night, or lunch) on the display.

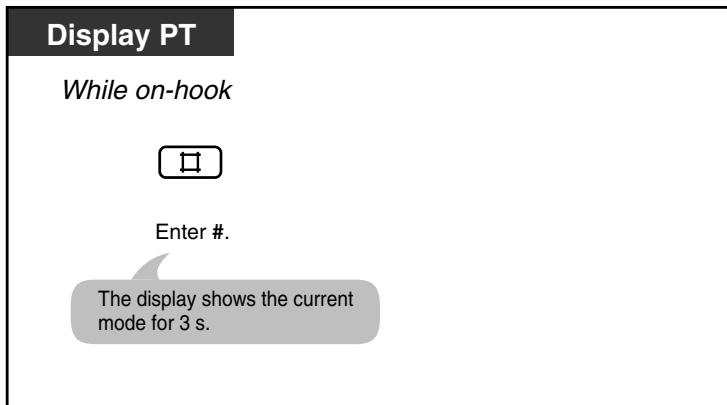

## 1.7.8 Clearing Features Set at Your Extension (Extension Feature Clear)

You can reset the settings of the following features on your extension to the default settings. This feature is also known as Station Feature Clear or Station Programme Clear.

Feature	Value after Extension Feature Clear
Absent Message	Off
Automatic Callback Busy	Off
Background Music (BGM)	Off
Call Forwarding (FWD)	Off
Call Pickup Deny	Allow
Call Waiting	Disable
Data Line Security	Off
Do Not Disturb (DND)	Off
Executive Busy Override Deny	Allow
Hot Line	The stored telephone numbers will be cleared.
Log-in/Log-out	Log-in
Message Waiting	All messages left by other extensions will be cleared.
Paging Deny	Allow
Room Monitor	Off
Timed Reminder	Cleared
Voice Mail Integration	Off

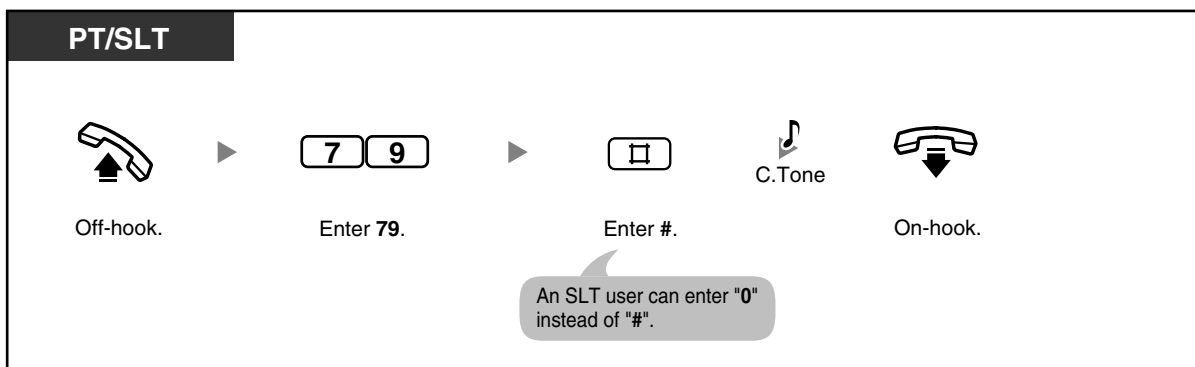

## 1.7.9 Monitoring a Room (Room Monitor)

You can monitor a room through another proprietary telephone (PT), or monitor a door through a doorphone. The PT you want to monitor should be set in advance to allow monitoring.

### To set

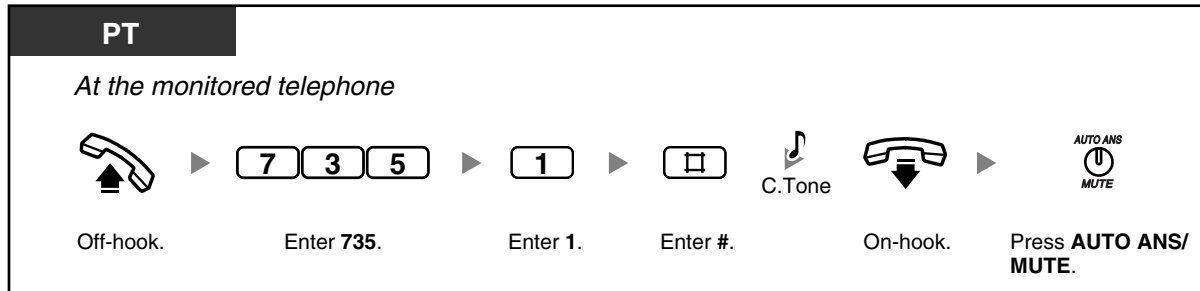

### To monitor

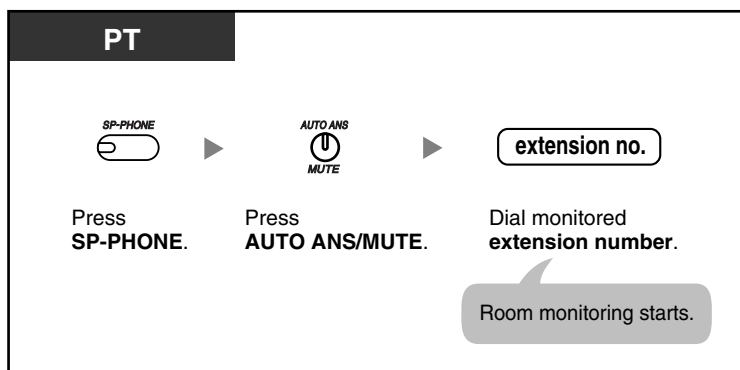

### To monitor through a doorphone

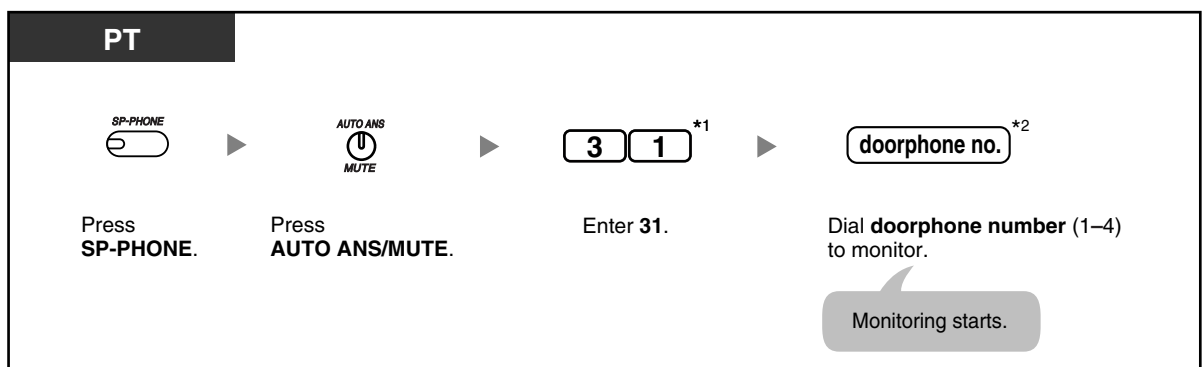

**To talk with a person in the monitored room**

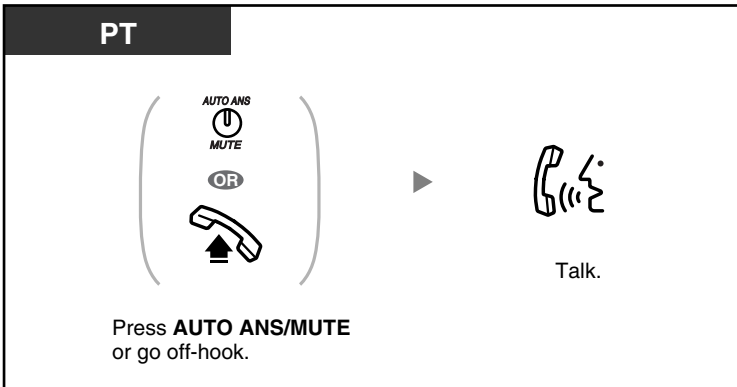

**To cancel a monitor**

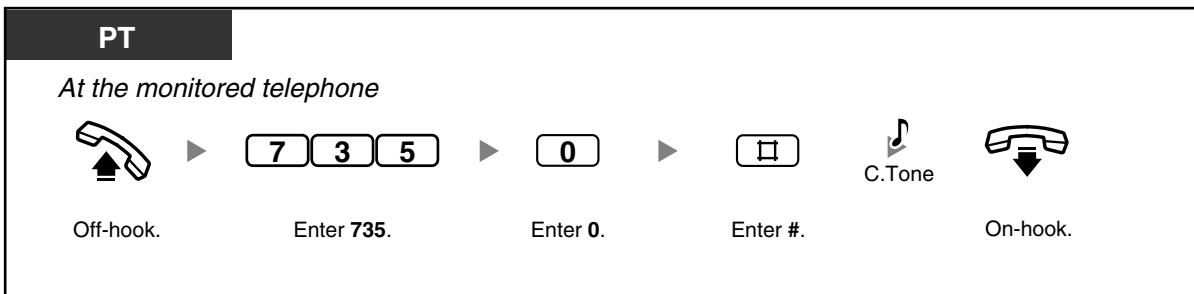

**To stop a monitor temporarily while on-hook**

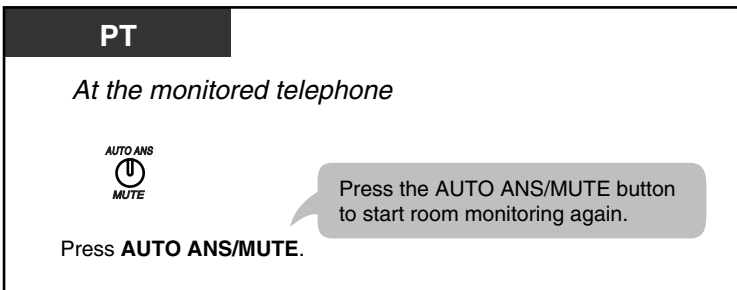

- \*1 Enter "#31" when "Plan 2" or "Plan 3" is selected as the numbering plan through system programming.
- \*2 When using an optional 2-port doorphone card, select "1" and/or "3" (not "1" and/or "2") as the doorphone number.
- You can monitor using a PT with an AUTO ANS/MUTE button or a single line telephone (SLT) with a MUTE button.
- The AUTO ANS/MUTE button light shows the current status as follows:  
**Off:** Not set  
**Flashing red:** Set (Ready for monitoring)



## 1.8 Using User-supplied Equipment

### 1.8.1 If a Doorphone/Door Opener is Connected

- Calling to and from a Doorphone (Doorphone Call)
- Opening a Door (Door Open)

#### ◆◆ Calling to and from a Doorphone (Doorphone Call)

You can talk to a person at the door through the doorphone. The extensions that are permitted to be called when a visitor presses the Call button on a doorphone are determined through system programming.

##### To call from the doorphone

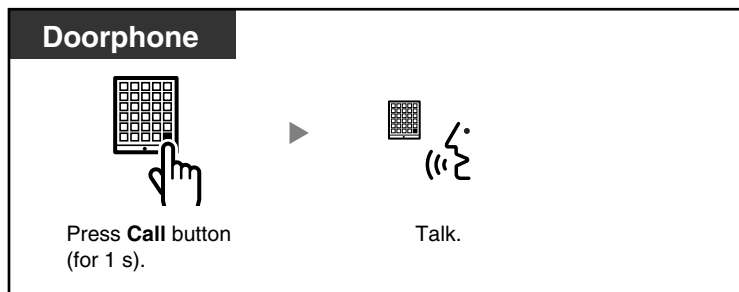

##### To answer a call from a doorphone



##### To call a doorphone

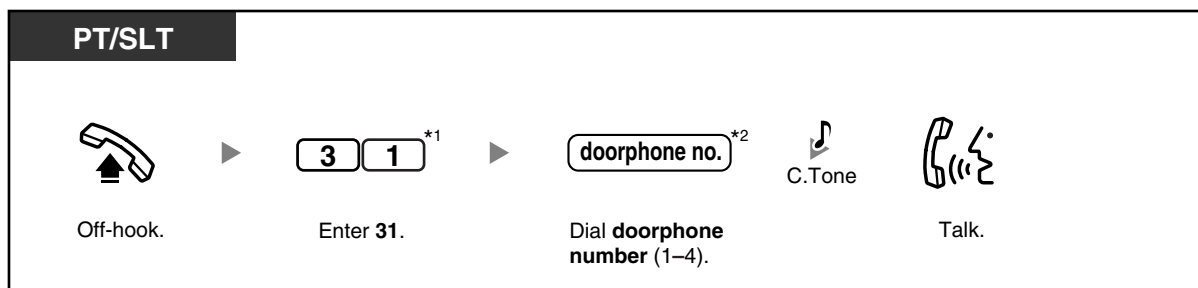

## 1.8 Using User-supplied Equipment



- \*1 Enter "#31" when "Plan 2" or "Plan 3" is selected as the numbering plan through system programming.
- \*2 When using an optional 2-port doorphone card, select "1" and/or "3" (not "1" and/or "2") as the doorphone number.
- If no one answers a doorphone call within a specified time period, ringing stops and the call is cancelled.
- When an optional 4-port doorphone card is installed in the PBX, doorphones 1 and 2 (or doorphones 3 and 4) cannot be used at the same time. When one is in use, you cannot have a conversation with the other.

### ◆◆ Opening a Door (Door Open)

You can unlock a door from your extension, if enabled through system programming.

#### From an enabled extension

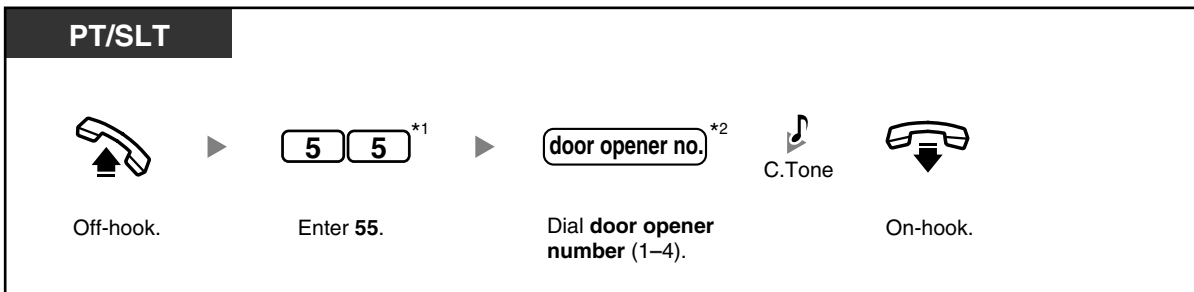

#### From an extension that is on a call with a doorphone

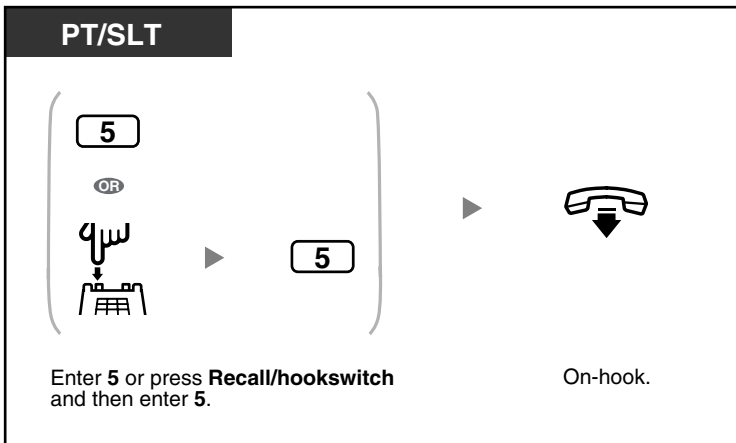

- \*1 Enter "#55" when "Plan 2" or "Plan 3" is selected as the numbering plan through system programming.
- \*2 When using an optional 2-port doorphone card, select "1" and/or "3" (not "1" and/or "2") as the door opener number.
- The door will stay open for a specified time period.
- **To keep the door open longer**, enter "5" again using a Panasonic proprietary telephone (PT).

## 1.8.2 If a Host PBX is Connected

- Accessing External Services (External Feature Access [EFA])

### ◆◆ Accessing External Services (External Feature Access [EFA])

You can access special features such as Call Waiting offered by another PBX or a telephone company. This feature is only available during outside (CO) line calls.

<Example> To hold the current call and then talk to the new party

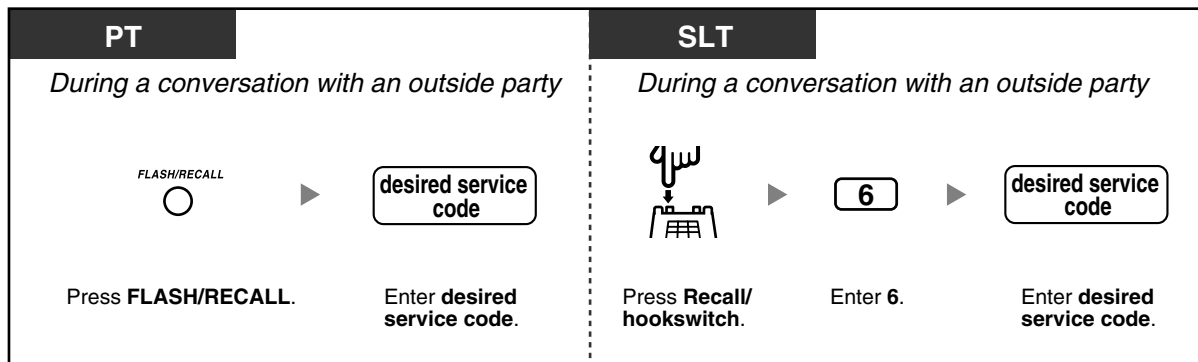

- Consult your dealer for the appropriate service codes.

### 1.8.3 If a Voice Processing System is Connected

You or an outside party can access the Voice Processing System (VPS) from a telephone.

- Forwarding Your Calls to a Voice Processing System (Voice Mail Integration)

If your PBX has a Panasonic VPS connected using APT Integration, the following features are also available:

- Screening Calls (Live Call Screening [LCS])
- Recording a Conversation (2-way Record)

#### ◆◆ Forwarding Your Calls to a Voice Processing System (Voice Mail Integration)

If you cannot answer calls, you can set them to be forwarded to your mailbox in a Panasonic VPS that supports either Inband (DTMF) Integration (e.g., KX-TVM/KX-TVP series VPS) or APT Integration (e.g., KX-TVM50/KX-TVP50 VPS). If your telephone has a MESSAGE button or Message/Ringer Lamp, the corresponding button or lamp turns on and lets you know you have messages. A single line telephone (SLT) user will hear dial tone 3 when going off-hook if there are any messages in his or her mailbox.

#### To set/cancel

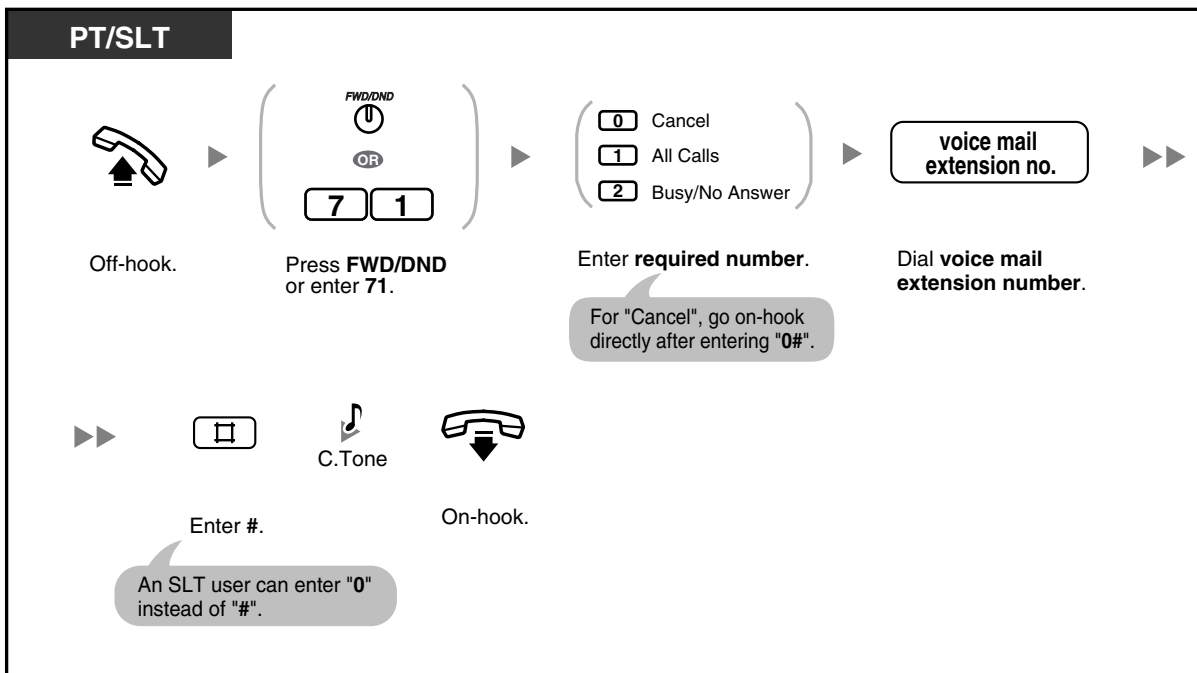



- If your PBX has a Panasonic VPS connected using Inband (DTMF) integration, your PBX automatically sends a special signal to the Voice Mail port before connecting the caller. To enable this feature, it may be necessary to set the signal format required by your VPS before setting the Call Forwarding (FWD) destination to Voice Mail as follows:
  - Setting A: only sends the extension number to the Voice Mail port. To set or cancel, enter "91#" or "90#" respectively after pressing the FWD/DND button or entering "71".
  - Setting B (default): sends "#6" followed by the extension number. "#6" is used by a Panasonic KX-TVM/KX-TVP series VPS to force the VPS port into voice mail service. To set or cancel, enter "92#" or "90#" respectively after pressing the FWD/DND button or entering "71".
 For more details, ask your manager or dealer.

### To listen to messages

PT/SLT



Off-hook.

MESSAGE

OR

(Message for Another Extension)

OR

voice mail extension no.

OR

7

8

4

☐

Press **MESSAGE**, **Message for Another Extension**, dial **voice mail extension number**, or enter **784#**.

An SLT user can enter "7840" instead of "784#".

### To transfer a call to a mailbox (APT Integration only)

PT

*During a conversation*



(Voice Mail Transfer)

(DSS)

OR

desired extension no.

Press **Voice Mail Transfer**.

Press **DSS** or dial **desired extension number**.



- If your VPS supports APT Integration, you can also transfer received outside (CO) line calls to a mailbox so that calling parties can leave messages. If you create a Voice Mail Transfer button on your phone, you can transfer calls to a desired extension without having to enter the mailbox number (Voice Mail Transfer). The maximum recording time for caller messages depends on the VPS.

## 1.8 Using User-supplied Equipment



- If a proprietary telephone (PT) user sets the FWD—Busy/No Answer feature, the FWD/DND button light will keep flashing while on-hook. To stop the button from flashing, go off-hook and enter "716#".



### Customising Your Phone

- 3.1.3 Customising the Buttons  
Create or edit an FWD/DND (Call Forwarding/Do Not Disturb) button, Message button, Message for Another Extension button, Voice Mail (VM) Transfer button, or Direct Station Selection (DSS) button.

## ◆◆ Screening Calls (Live Call Screening [LCS])

While a caller is leaving a message in your mailbox, you can monitor the call, and choose whether to answer or not. There are 2 methods available. (Default: Hands-free mode)



No SLT

### Hands-free mode:

You can monitor the message automatically, live through the telephone speaker.

### Private mode:

You will hear the following alert tone while the caller is leaving a message.

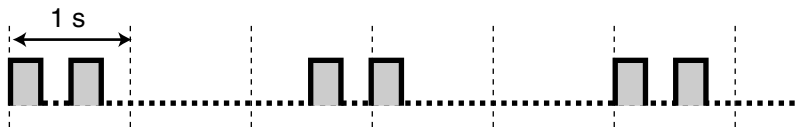

### Before operating

- Create a Live Call Screening (LCS) button.
- Select the mode, either Hands-free or Private.
- Set the LCS password.
- Set the LCS feature.

### To set/cancel the LCS password

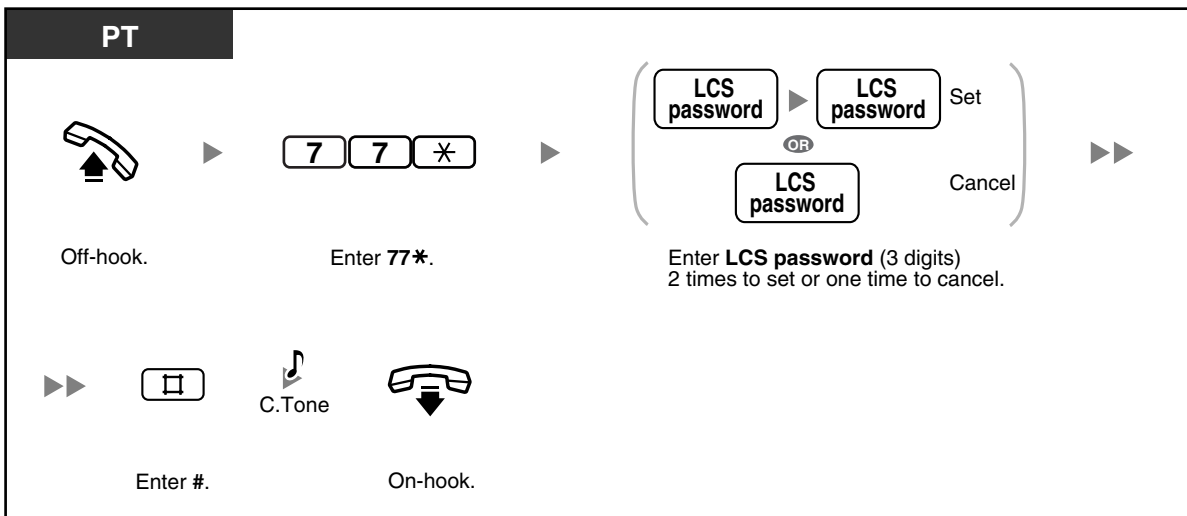

### To set LCS

**PT**

*While on-hook*

 (Live Call Screening) ▶ **LCS password**

Press **Live Call Screening**.      Enter **LCS password**.

### To cancel LCS

**PT**

*While on-hook*

 (Live Call Screening)

Press red **Live Call Screening**.

### Operation Flowchart

The operations in the shaded areas can be performed in hands-free mode.

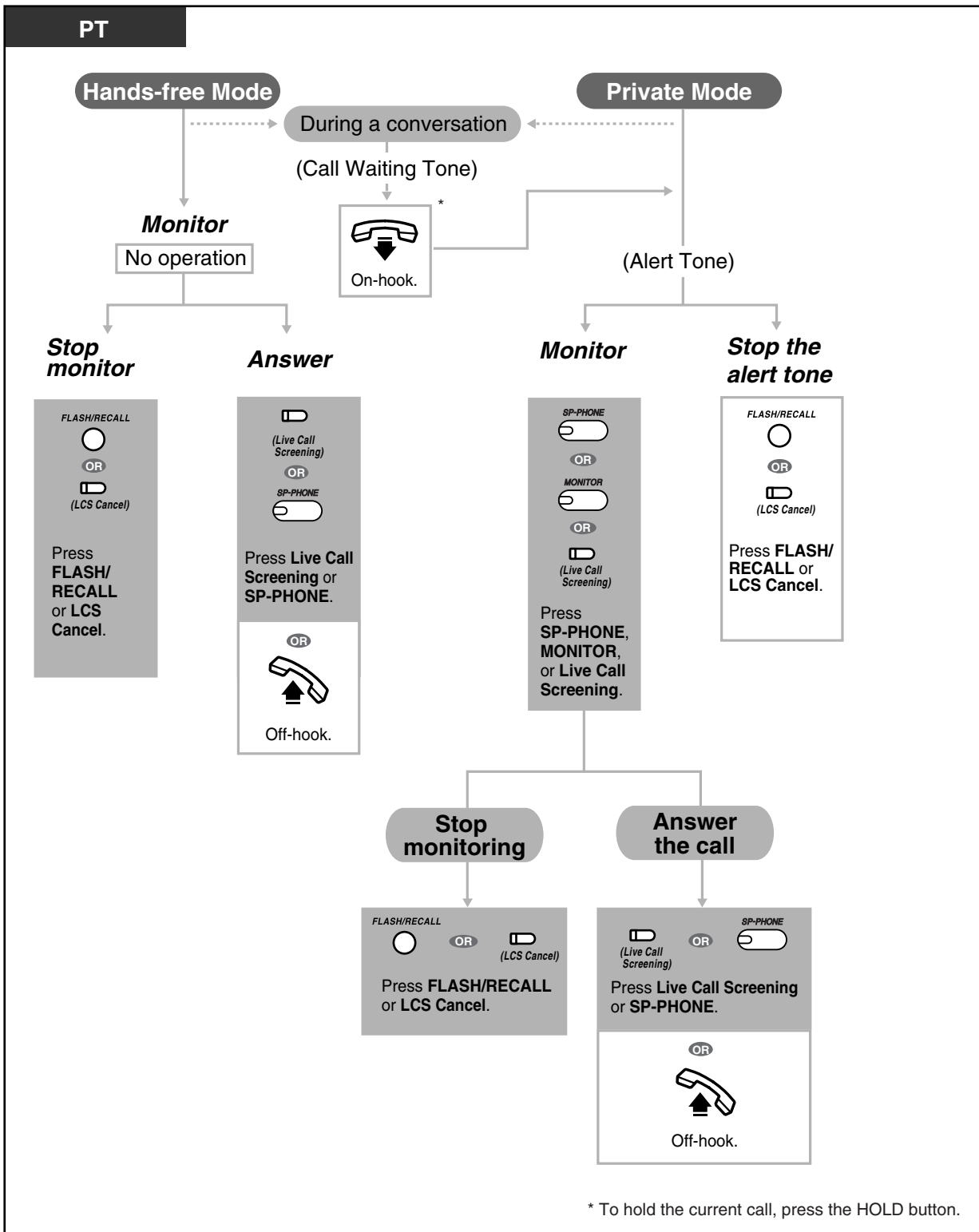





- The Live Call Screening (LCS) button light shows the feature status as follows:
  - Off:** LCS is off.
  - Flashing green rapidly:** An alert tone is ringing (Private mode only).<sup>\*1</sup>
  - Flashing green slowly:** Monitoring.<sup>\*2</sup>
  - Red on:** LCS is on.
- <sup>\*1</sup> The Direct Station Selection (DSS) button light flashes red at moderate speed while an alert tone is ringing.
- <sup>\*2</sup> The DSS button light flashes red slowly while monitoring.
- The operator or manager can clear the LCS password at any extension.



### Customising Your Phone

- 3.1.2 Changing Personal Settings Using Programming Mode—**Live Call Screening [LCS] Mode Set**  
Select the mode, either monitoring the message through the speaker automatically or receiving an alert tone, while the caller leaves a message.
- 3.1.3 Customising the Buttons  
Create or edit a Live Call Screening (LCS) button or LCS Cancel button.

## ◆◆ Recording a Conversation (2-way Record)

You can record a conversation into a mailbox while talking on the phone. You can select the mailbox each time you record a conversation.



No SLT

### To record into your mailbox



### To record into another mailbox (2-way Transfer)

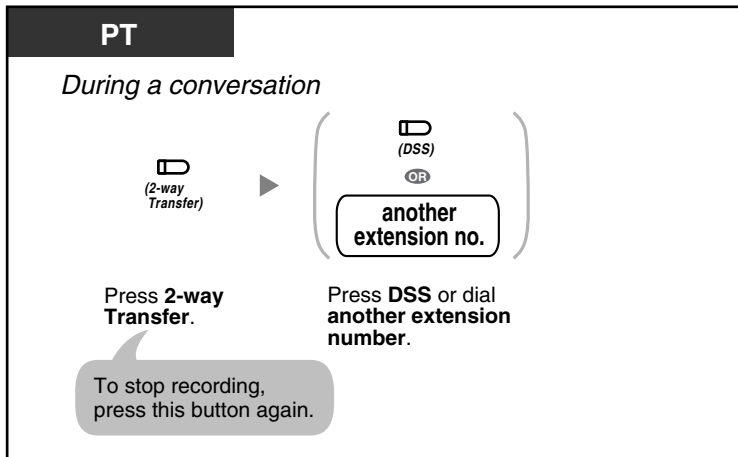

- The 2-way Record button light or 2-way Transfer button light shows the current status as follows:  
**Off:** Not recording.  
**On:** Recording the conversation.



- **Note:**  
When you record your 2-way telephone conversations, you should inform the other party that the conversation is being recorded.



#### Customising Your Phone

- 3.1.3 Customising the Buttons  
Create or edit a 2-way Record button, 2-way Transfer button, or Direct Station Selection (DSS) button.

## 1.9 Using a Display Proprietary Telephone

### 1.9.1 Calling with the Incoming Call Log

If your PBX receives caller information from the telephone company (phone number and/or caller name), the PBX automatically logs this information each time you do not answer an outside (CO) line call. You can view a log of unanswered calls later to see who called and when, and use this information to call back the callers.

There are 2 types of call log areas available in the PBX. One is the personal area, which logs calls for each extension separately. The other is the common area, which logs calls to multiple extensions and calls via Direct Inward System Access (DISA) Intercept Routing. Up to 20 calls can be logged in each personal area and up to 300 calls in the common area.

When the call log in the personal area is full, new calls can either be disregarded or can overwrite the oldest calls that have already been viewed in the personal area call log. Similarly, when the call log in the common area is full, new calls can either be disregarded or can overwrite the oldest calls that have already been viewed in the common area call log. For more details, refer to "2.1.5 Disregarding the Newest Call or Overwriting the Oldest Call in the Common Area Call Log (301st Incoming Call Logged in the Common Area)".

Voice messages recorded by Built-in Voice Message (BV) are stored separately from caller information. However, when a caller leaves a voice message, it is automatically linked to the caller information in the Incoming Call Log. Up to 125 voice messages can be logged. For more details, refer to "1.5.5 Using Voice Messaging (Built-in Voice Message [BV])".

You can also set caller information to be automatically logged into your personal area or the common area even when you answer an outside (CO) line call.

Additionally, logged phone numbers can be edited so that you can call callers back without worrying about outside (CO) line access numbers, area codes, etc.

The following information is logged:

- Caller's Phone Number & Name
- Date/Time of receiving call
- Voice Message (if stored)

#### To check the number of logged calls

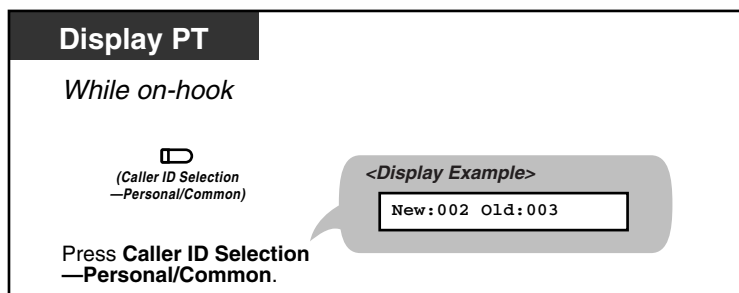

- Since the status of call records is always shown on the bottom of a PT with a 3-line display such as the KX-T7735, pressing the Caller ID Selection—Personal/Common button while on-hook is not necessary. If both a Caller ID Selection—Personal button and a Caller ID Selection—Common button are assigned to a PT, the status of call records of the Caller ID Selection—Common button are shown on the display while on-hook.

## 1.9 Using a Display Proprietary Telephone



- **New:** Call records that have not previously been viewed
  - **Old:** Call records that have previously been viewed
- Both new and old call records are stored in each personal and common area.

### To view caller information and call back a caller

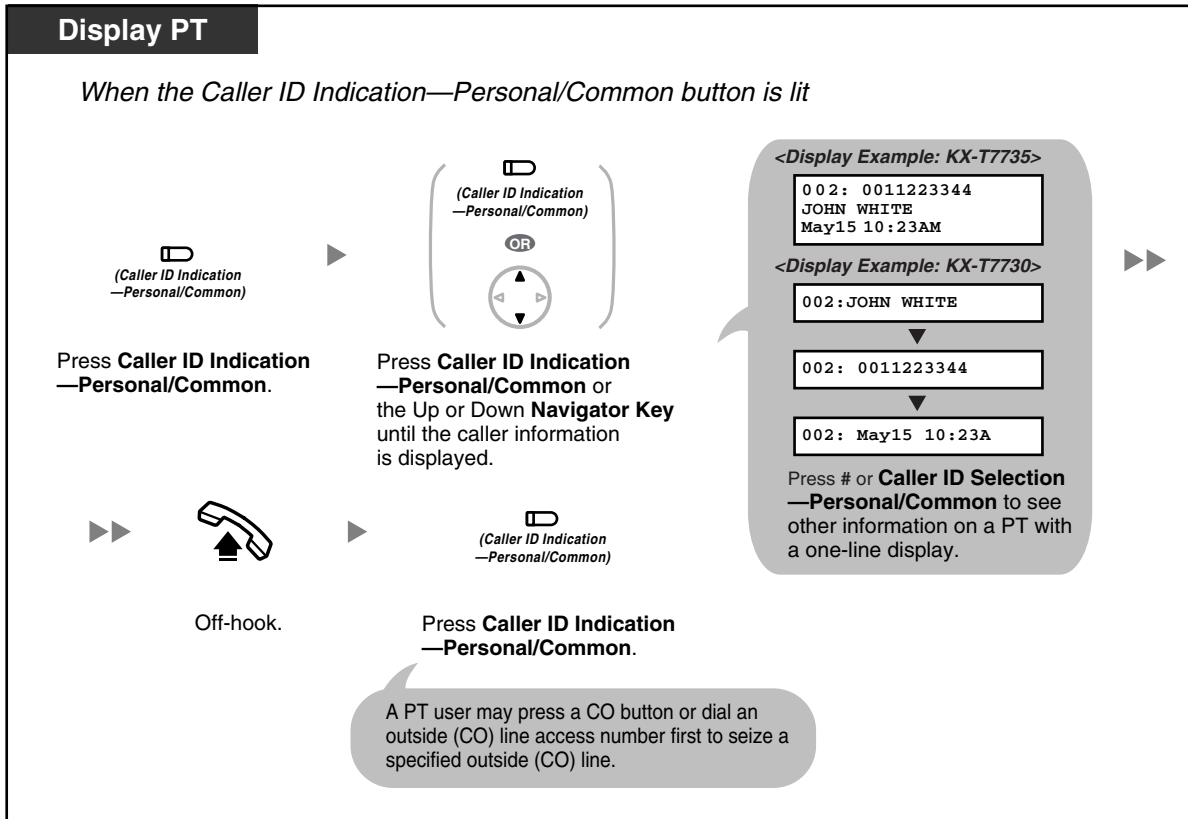

### To erase caller information

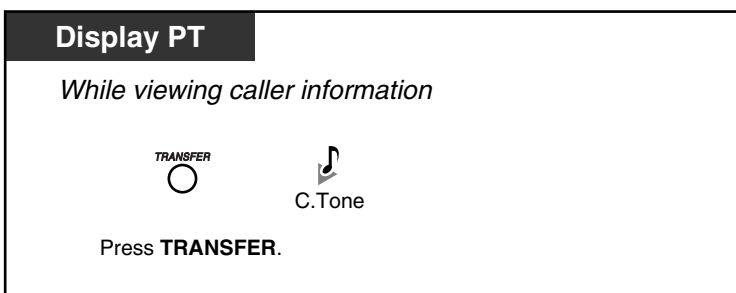

- Only 12 digits (or characters) of a caller's number (or name) can be displayed even though up to 16 digits (or characters) of information can be received. To scroll the display, press the FWD/DND (Call Forwarding/Do Not Disturb) button.



- To return to the idle status display, go off-hook and then on-hook. The display also returns to the idle status display automatically if no operation is performed for 20 seconds.
- To modify the logged telephone number, press the HOLD button to erase digits and then use 0 to 9, \*, and PAUSE to add numbers in front of the first digit.

### To view caller information and play back an associated voice message in a voice message area

**Display PT**

*While viewing caller information with an associated voice message  
(When the Message/Ringer Lamp or the MESSAGE button is lit)*



Press **MESSAGE**.      Listen to the message.

### To erase caller information, including associated voice message in a voice message area

**Display PT**

*While viewing caller information or  
after playing back the associated voice message*



Press **TRANSFER**.      Press **TRANSFER** again to confirm the deletion.

The caller information is erased.



- When viewing caller information with the Caller ID Indication—Common button, an extension user other than the operator or manager cannot play back associated voice messages in the common message area. Voice messages in the common message area can be played back or erased by the operator or manager only.
- If voice messages without caller information are recorded, "Voice Message" will be shown on a display PT instead of the caller's phone number while you are viewing caller information.
- Even if there are message waiting indications left at your extension, the Message/Ringer Lamp or the MESSAGE button light that displays notifications from the Message Waiting feature turns off while you are viewing caller information with the Caller ID Indication—Personal/Common button.
- If your telephone has no MESSAGE button, you cannot play back associated voice messages while viewing caller information.

**To erase all caller information in the personal area**

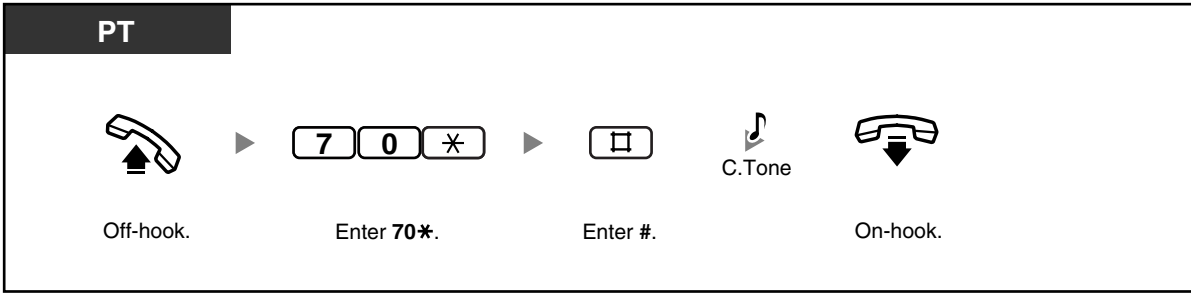

- Caller information with associated voice messages is not erased by this operation.
- !! • To erase all caller information in the common area, refer to "2.1.4 Erasing All Caller Information in the Common Area (Incoming Call Log in the Common Area—CLEAR ALL)".

**To disregard the newest call/overwrite the oldest call in the personal area call log**

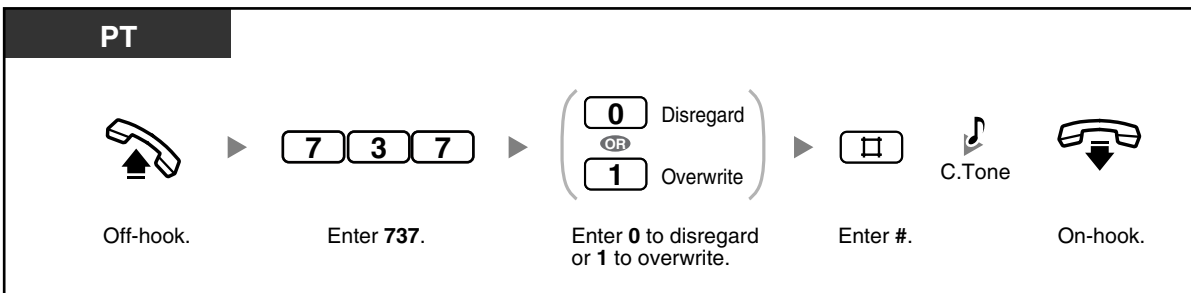

**To set/cancel logging of caller information when answering a call**

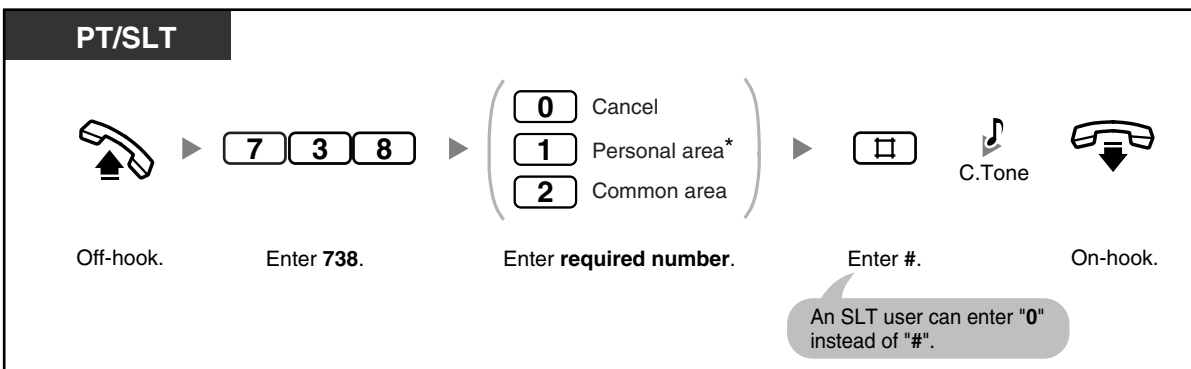

- If you press the Caller ID Indication—Personal/Common button during a conversation, the caller's information is logged regardless of this setting.
- You can set logging of caller information in both the personal area and the common area at the same time.
- \* When using a single line telephone (SLT), you cannot log caller information in the personal area.



- New information of calls that you did not answer will be displayed first.
- Information of answered calls is logged as old (already viewed) information.



- A Caller ID Indication—Personal/Common button can be used to:
  - Inform you of calls logged in your personal area or the common area,
  - Store the information of an incoming call during a conversation, and
  - View caller information while on-hook and call back a caller whose information is stored in your personal area or the common area.
- A Caller ID Selection—Personal/Common button can be used to:
  - Display and cycle through the information of an incoming call during a conversation, while receiving a call, or while viewing caller information,
  - Display the number of logged calls while on-hook, and
  - Inform you that the personal or common area call log is full.
- If a Caller ID Indication—Common button is not assigned to any PT when calls arrive at multiple PTs or via the DISA Intercept Routing feature, caller information will be logged in the personal area of the PT that is connected to the lowest-numbered jack on the PBX, and a Caller ID Indication—Personal button will light.
- Even if you answer a call, you can log the caller's information by pressing the Caller ID Indication button during the conversation.
- You can lock your personal area call log (including caller information with associated voice messages) so that other extensions cannot access your logged information. Refer to "1.5.3 Preventing Other People from Using Your Telephone (Extension Lock)".
- Caller information is also logged for unscreened transferred calls, even if not answered. In this case, the caller information will be logged in the final destination's personal area.



### Customising Your Phone

- 3.1.3 Customising the Buttons  
Create or edit a Caller ID Indication—Personal button, Caller ID Indication—Common button, Caller ID Selection—Personal button, Caller ID Selection—Common button, or Message button.

## 1.9 Using a Display Proprietary Telephone

---



---

## **Section 2**

# ***Operator/Manager Operation***

*This chapter shows the operator and the manager extension how to control the other extensions or the PBX. Your PBX supports one manager (extension jack 01) and one operator.*

## 2.1 Control Features

### 2.1.1 Locking Other Extensions (Remote Extension Lock)

The operator or manager can lock or unlock an extension.  
This feature is also known as Remote Station Lock Control.



#### To lock/unlock

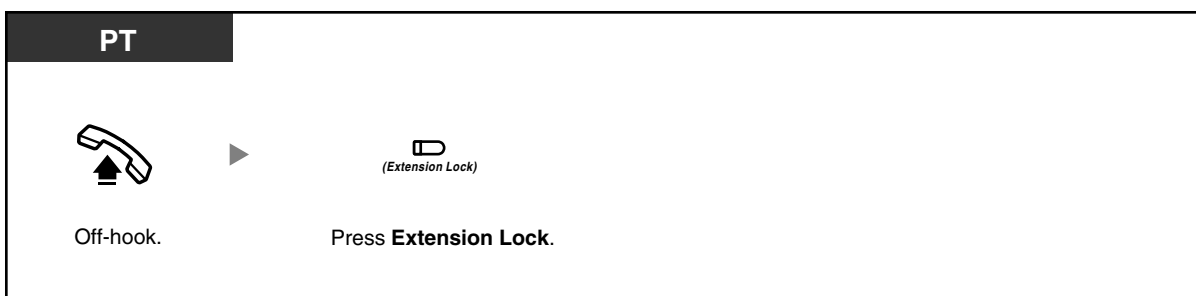

- This feature overrides the Extension Lock feature. If Extension Lock has already been set by the extension user and this feature is set afterwards, the extension user cannot cancel the lock. Only the operator or manager can cancel the lock.
- The Extension Lock—CANCEL ALL feature can cancel all locks placed on extensions using this feature. Refer to "2.1.7 Changing System Settings Using Programming Mode".
- This operation can be performed only if the operator or manager has set the extension password of the corresponding extension. Refer to "2.1.7 Changing System Settings Using Programming Mode".



#### Customising Your Phone

- 3.1.3 Customising the Buttons  
Create or edit an Extension Lock button.

## 2.1.2 Switching the Time Service Mode (Time Service)

The PBX can be programmed to make and receive calls differently in each time service mode (day, night, and lunch).

The time service mode can be set to be changed manually (manual mode) or automatically at preprogrammed times (automatic mode) through system programming. Even if automatic mode has been selected, the operator or manager can change the current time service mode manually.



### To change the time service mode manually

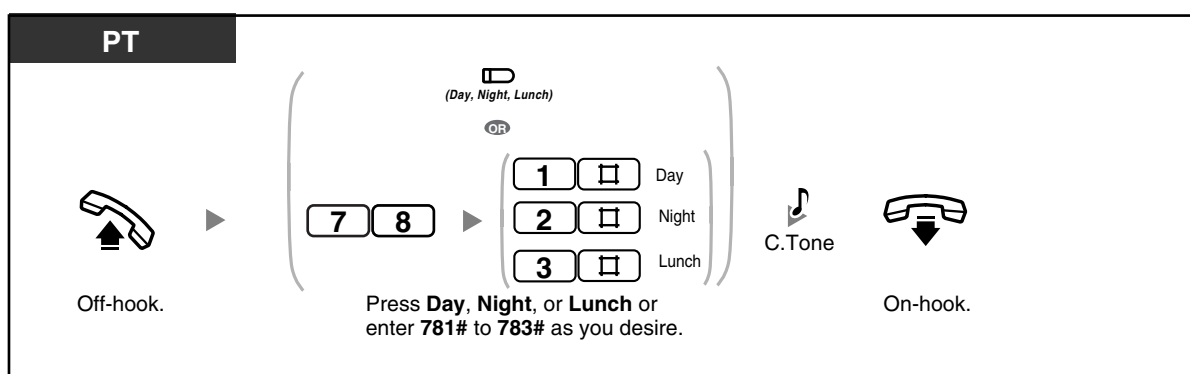

### To return to automatic mode after changing the time service mode manually

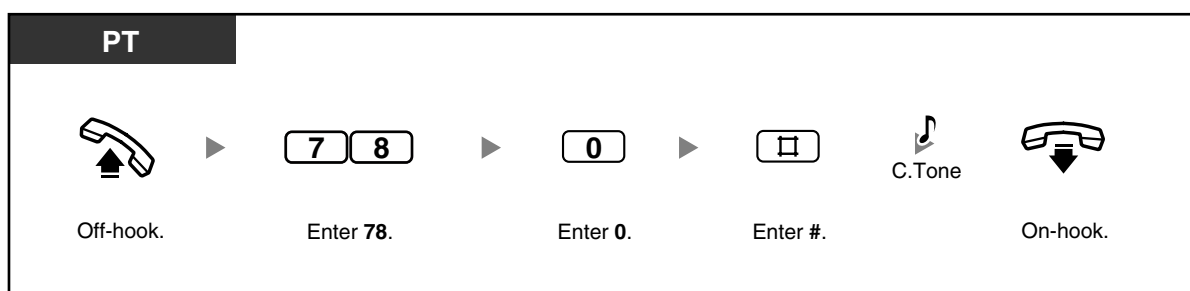

### To confirm the current time service mode

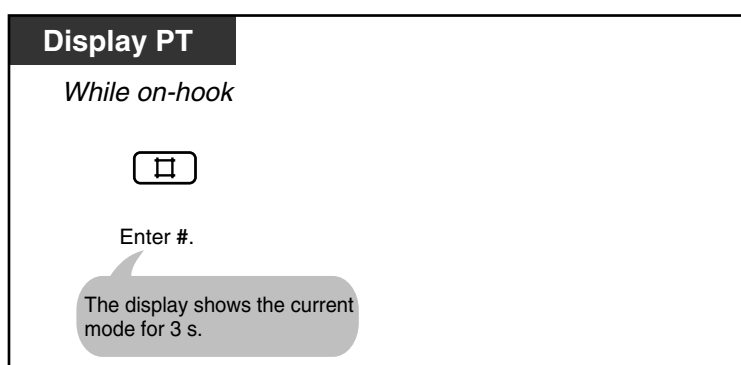

## 2.1 Control Features

---



- The Day, Night, and Lunch button lights show the current status as follows:  
**Off:** Not set  
**Red on:** Set
- If lunch mode is set manually by entering "783#" while in automatic mode, the time service mode will not change automatically until you return to automatic mode by entering "780#". However, if day mode or night mode is set manually, the mode will still change automatically as programmed.
- It is not possible to cancel the current time service mode while in manual mode. Instead, enter the feature number corresponding to the time service mode you wish to set.



### Customising Your Phone

- 3.1.3 Customising the Buttons  
Create or edit a Day button, Night button, or Lunch button.

## 2.1.3 Setting an Alarm for Other Extensions (Remote Timed Reminder [Wake-up Call])

The operator or manager can remotely set or cancel the Timed Reminder feature for any extension.



### To set

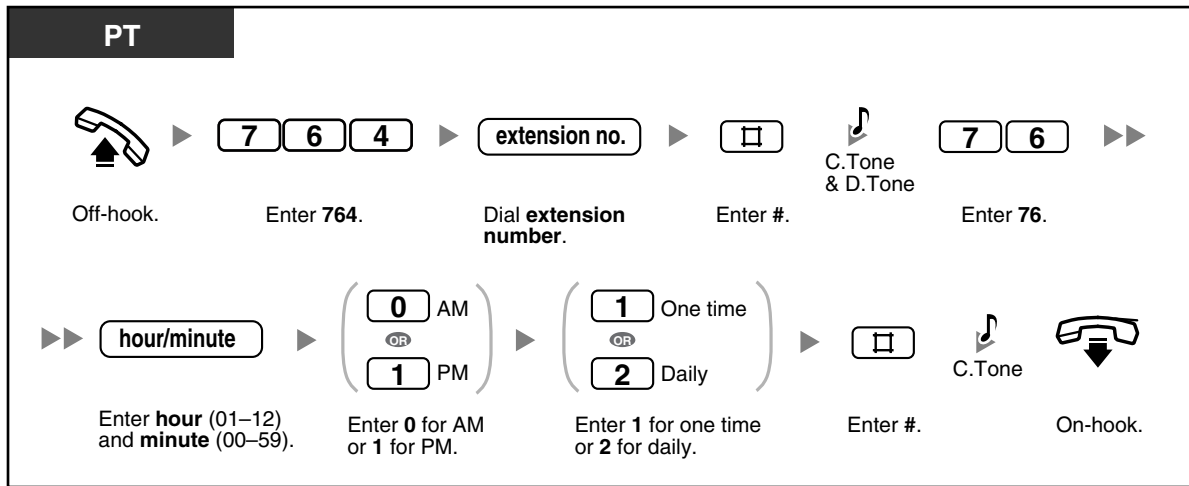

### To cancel

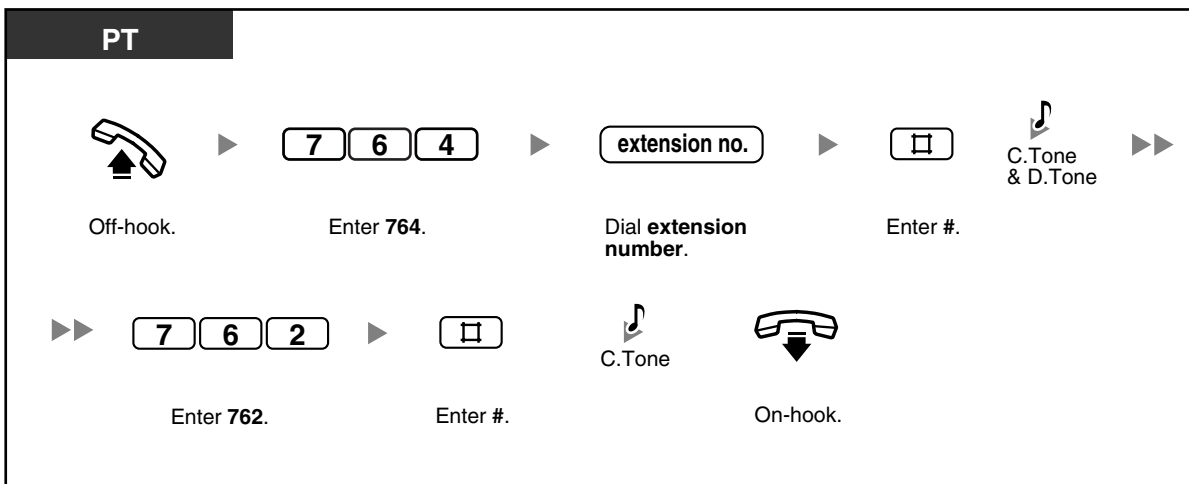

To confirm

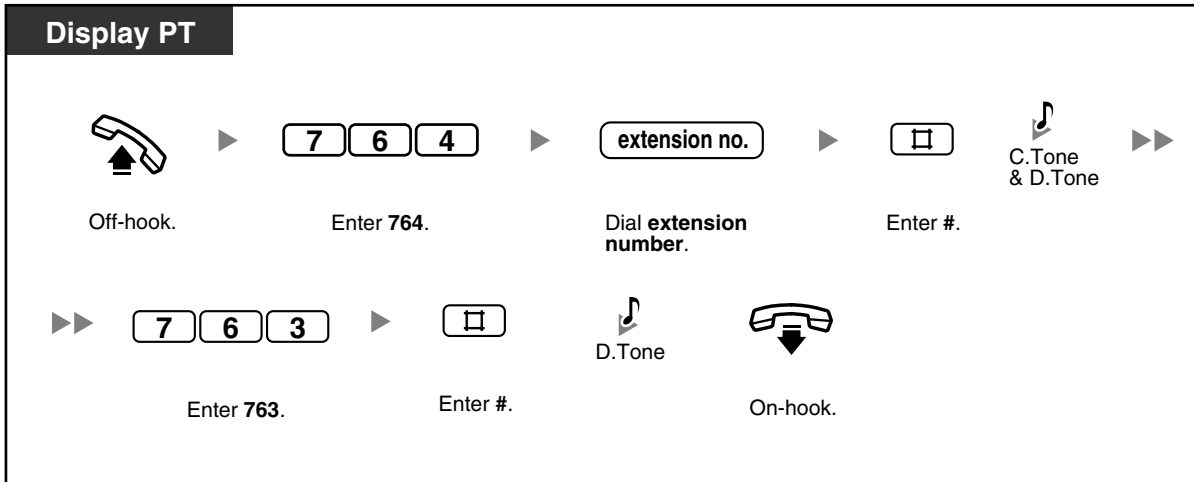

## 2.1.4 Erasing All Caller Information in the Common Area (Incoming Call Log in the Common Area—CLEAR ALL)

The operator or manager can erase all caller information logged in the common area.



To erase

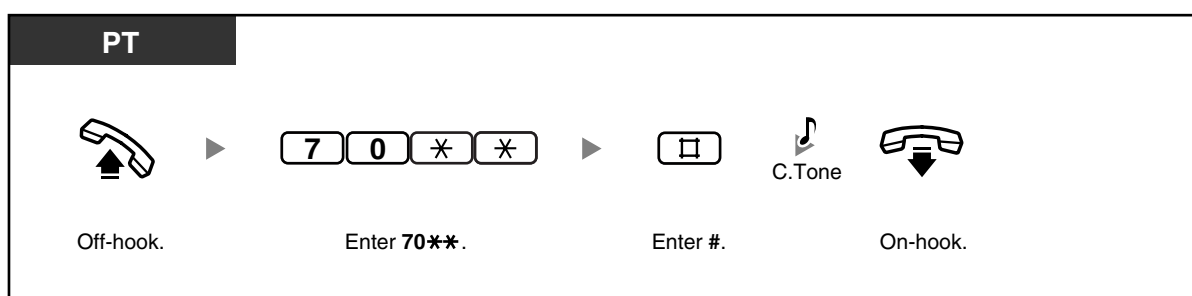

- Caller information with associated voice messages is not erased by this operation.
- This feature is not available while someone is viewing caller information logged in the common area.

## 2.1.5 Disregarding the Newest Call or Overwriting the Oldest Call in the Common Area Call Log (301st Incoming Call Logged in the Common Area)

The call log in the common area can store up to 300 call records. The operator or manager can select how new calls are treated when this call log is full; either the newest call is disregarded (i.e., not logged), or the oldest call whose information has been viewed is overwritten by the newest call. The Caller ID Selection—Common button lights when the call log in the common area is full.



### To disregard the newest call/overwrite the oldest call in the common area call log

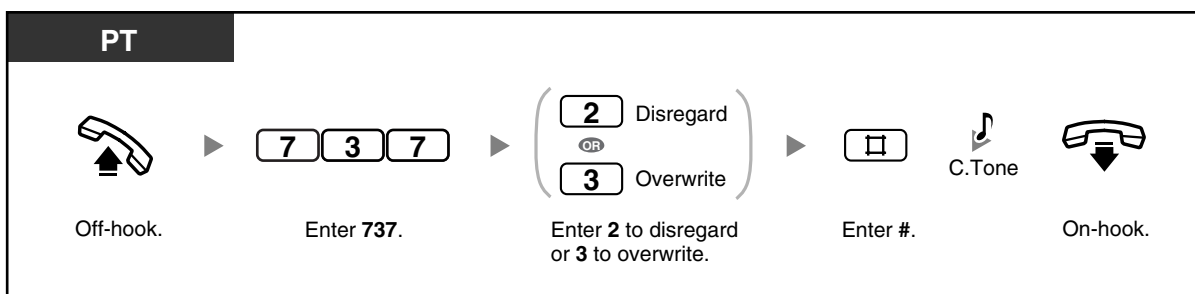



## 2.1.6 Recording, Playing, or Erasing Common BV Outgoing Messages

If an optional voice message card is installed in the PBX, the operator or manager can record, play, or erase a common Built-in Voice Message (BV) outgoing message (OGM) in the common message area. When an outside (CO) line call is automatically directed to the common message area, or when a Direct Inward System Access (DISA) call is redirected to the common message area via Intercept Routing, the caller will hear a common BV OGM and can leave a voice message. To play back or erase the voice message, refer to "1.5.5 Using Voice Messaging (Built-in Voice Message [BV])".

### To record

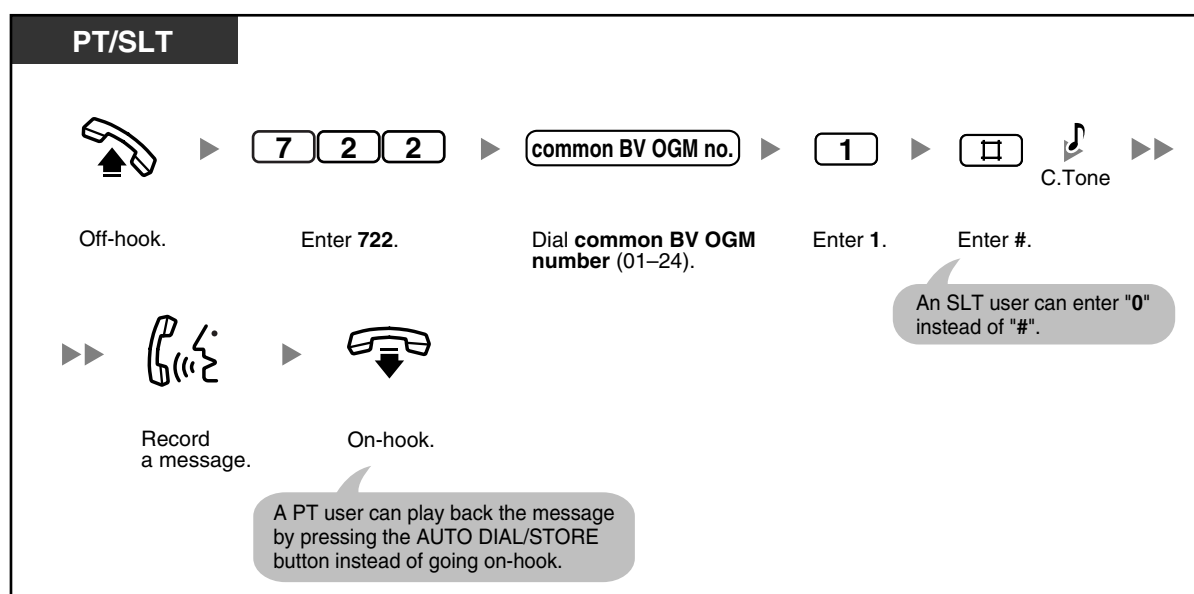

### To play back

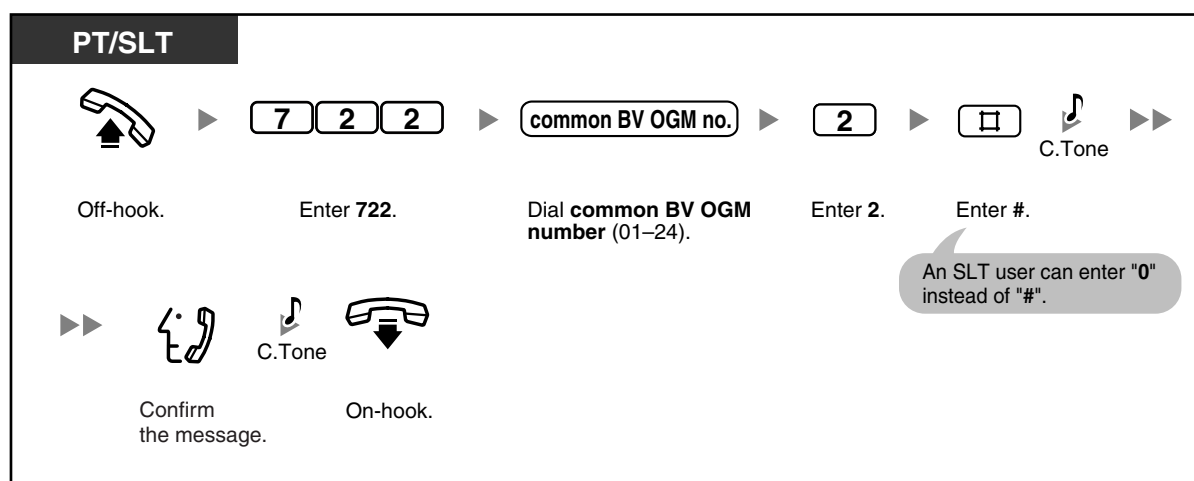

- The AUTO DIAL/STORE button light shows the current status as follows:
  - Off:** You are recording a message, or a message has finished playing.
  - Red on:** A message is playing.
- You can stop playback by pressing the AUTO DIAL/STORE button.

To erase

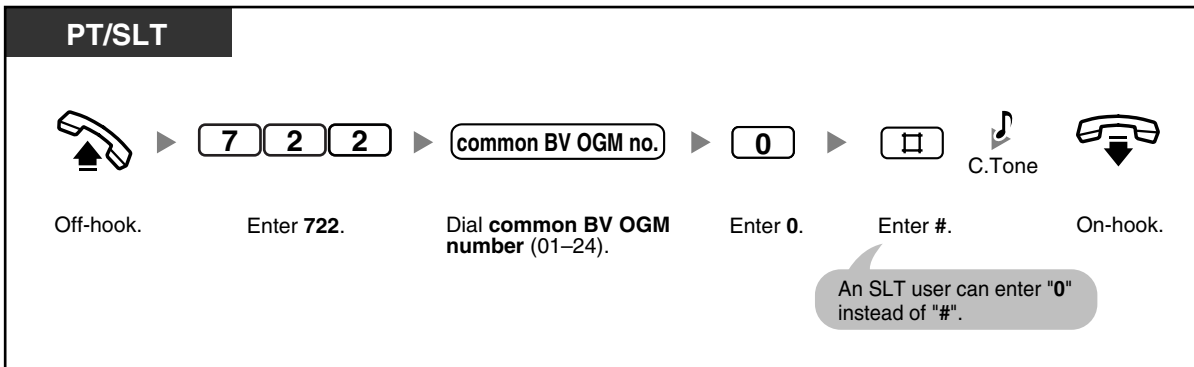

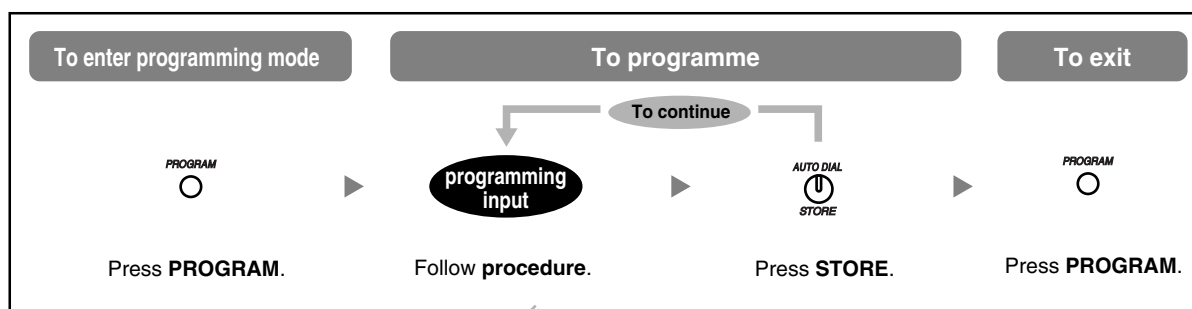

## 2.1.7 Changing System Settings Using Programming Mode

The operator or manager can set the following system features while in programming mode.



Setting	Procedure
Adjusting the current date and time <b>(Date &amp; Time Set)</b>	<b>0</b> <b>date and time</b> *1
Cancelling Extension Lock, Incoming Call Log Display Lock in the Personal Area, and Message Waiting for Another Extension Lock at all extensions <b>(Extension Lock—CANCEL ALL)</b>	<b>8</b>
Clearing the Live Call Screening (LCS) Password <b>(LCS Password Control)</b>	<b>□</b> <b>2</b> <b>extension no.</b>
Setting a password to each extension <b>(Extension Password Set [Manager only])*2</b>	<p><b>7</b> <b>manager password</b> *3 + <b>AUTO DIAL STORE</b> + <b>SP-PHONE</b></p> <p><b>To continue</b></p> <p>+ <b>extension password</b> + <b>AUTO DIAL STORE</b> + <b>( SP-PHONE OR REDIAL )</b> *4</p>

## 2.1 Control Features

Setting	Procedure
<p>Recording or Playing Outgoing Messages used by DISA, UCD, and 3-level AA  <b>(Outgoing Message [OGM] for DISA/UCD)*5</b></p>	<p><b>9</b> <b>X</b> *6</p> <p>X = <b>0</b> (To erase OGMs for Direct Inward System Access [DISA]/Uniform Call Distribution [UCD]):</p> <p><b>DISA/UCD OGM (1–8)</b> +  *7</p> <p><b>1</b> (To record OGMs for DISA/UCD):</p> <p><b>DISA/UCD OGM (1–8)</b> + Record +  *8</p> <p><b>2</b> (To play OGMs for DISA/UCD):</p> <p><b>DISA/UCD OGM (1–8)</b> *9</p> <p><b>3</b> (To record OGMs for 3-level Automated Attendant [AA]):</p> <p>(For 2-level AA)</p> <p><b>AA no. for 2-level DISA OGM (0–9)</b> + *</p> <p>(For 3-level AA)</p> <p><b>AA no. for 2-level DISA OGM (0–9)</b> + <b>AA no. for 3-level DISA OGM (0–9)</b> ) + Record +  *8</p> <p><b>4</b> (To play OGMs for 3-level AA):</p> <p>(For 2-level AA)</p> <p><b>AA no. for 2-level DISA OGM (0–9)</b> + * *10</p> <p>(For 3-level AA)</p> <p><b>AA no. for 2-level DISA OGM (0–9)</b> + <b>AA no. for 3-level DISA OGM (0–9)</b> *10</p>



- **WARNING**  
**There is a risk that fraudulent telephone calls will be made if a third party discovers your password.**  
**The cost of such calls will be billed to the owner/renter of the PBX.**  
**To protect the PBX from this kind of fraudulent use, we strongly recommend:**
  - a) **Keeping your password secret.**
  - b) **Selecting complex, random password that cannot be easily guessed.**
  - c) **Changing your password regularly.**
- \*1 Year (00–99), Month (01–12), Day (01–31), Day of the week (0–6: Sun–Sat), Hour (01–12), Minute (00–59), AM/PM (0/1)
- \*2 The preprogrammed extension password can be used for the Walking COS feature and the Remote Extension Lock feature. Each extension's password must be unique.
- \*3 The manager password is the password of the extension connected to extension jack 01. You can enter the system password instead of the manager password. Ask your administrator or dealer for the manager password or system password.
- \*4 Extension numbers are displayed in the order of the jack numbers when you press the SP-PHONE (NEXT) or REDIAL (PREV) button.
- \*5 Up to 32 messages (DISA/UCD: max. 8, 3-level AA: max. 24) can be recorded. A message can be up to 3 minutes long. The total recording time of the PBX for DISA/UCD OGMs is 3 minutes. When an optional message expansion card for DISA/UCD OGMs is added, the total recording time of the PBX is increased to 6 minutes. When the total time of all recordings becomes 3 (or 6) minutes or more, the PBX automatically stops recording. Record messages using the handset (not the Hands-free microphone), to reduce background noise.
- \*6 Before entering "9", go off-hook.
- \*7 "Delete Complete" is shown on a display proprietary telephone (PT). While this message is shown, you can enter "0", "1", or "2", to erase, record, or play any OGMs for DISA/UCD.
- \*8 The message is played back.
- \*9 While the message is being played back, you can enter "0", "1", or "2", to erase, record, or play any OGMs for DISA/UCD, or press the SP-PHONE (NEXT) or REDIAL (PREV) button to start playing other OGMs for DISA/UCD. To exit programming mode after the message has played, press the HOLD button and then the PROGRAM button, or go off-hook and then on-hook.
- \*10 While the message is being played back, you can enter "3" or "4", to record or play any OGMs for 3-level AA, or press the SP-PHONE (NEXT) or REDIAL (PREV) button to start playing other OGMs for 3-level AA. To exit programming mode after the message has played, press the HOLD button and then the PROGRAM button, or go off-hook and then on-hook.

## 2.1 Control Features

---

---

## **Section 3**

# ***Customising Your Phone & PBX***

*This chapter shows you how to customise your proprietary telephone (PT) or PBX according to your needs.*

## 3.1 Customising Your Phone (Personal Programming)

### 3.1.1 Customising Your Phone (Personal Programming)

You can customise various features of your telephone, such as line preferences and customised buttons. Additionally, you can return all customised features to their default settings.



- Because certain settings are retained in your proprietary telephone (PT) (not in the PBX), before replacing or changing your PT, we recommend resetting all customised features to their default settings.
- The PROGRAM button is used to enter or exit programming mode.
- In order to programme your extension, it must be idle, on-hook, and holding no calls.
- While you are programming your extension, it is treated as a busy extension.



### 3.1.2 Changing Personal Settings Using Programming Mode

You can perform the following while in programming mode:

- Setting Features
- Clearing Features
- Confirming Your Own Extension Number (Self-extension Number Confirmation)

#### ◆◆ Setting Features

The default settings are shown in bold letters. For later reference, place a check mark in the boxes below to indicate your customised setting.

**Notice**

Default settings may vary depending on your country/area. For more details, consult your dealer.

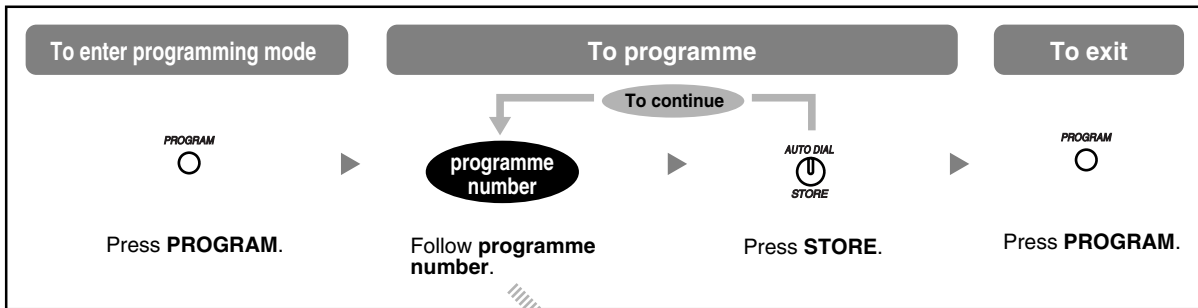

Item	Programme Number	Setting
Which line do you prefer to seize when you go off-hook to make a call? (Line Preference—Outgoing)	[ 1 ] [ 1 ]	<input type="checkbox"/> <b>No line</b>
	[ 1 ] [ 2 ]	<input type="checkbox"/> An idle outside (CO) line
	[ 1 ] [ 3 ] + outside (CO) line no. (1–8)*	<input type="checkbox"/> An assigned outside (CO) line
Which line do you prefer to answer when you go off-hook? (Line Preference—Incoming)	[ 2 ] [ 1 ]	<input type="checkbox"/> No line
	[ 2 ] [ 2 ]	<input type="checkbox"/> <b>A ringing line</b>
	[ 2 ] [ 3 ] + outside (CO) line no. (1–8)*	<input type="checkbox"/> An assigned outside (CO) line
From which outside (CO) lines do you want to receive calls at your extension? (Outside (CO) Line Ringing Selection)	[ 3 ] + outside (CO) line no. (1–8)*	<input type="checkbox"/> Ring—assigned outside (CO) lines
		<input type="checkbox"/> <b>Ring—all outside (CO) lines</b>

### 3.1 Customising Your Phone (Personal Programming)

Item	Programme Number	Setting
How do you prefer to receive intercom calls? (Alternate Receiving—Ring/Voice)	<input type="text" value="4"/> <input type="text" value="1"/>	<input type="checkbox"/> <b>Ring</b> (Tone Call)
	<input type="text" value="4"/> <input type="text" value="2"/>	<input type="checkbox"/> Directly—The party's voice is heard without ringing.
Which call waiting tone do you prefer for intercom/outside (CO) line calls? (Call Waiting Tone Type Selection)	<input type="text" value="5"/> <input type="text" value="1"/>	<input type="checkbox"/> <b>Tone 1</b>
	<input type="text" value="5"/> <input type="text" value="2"/>	<input type="checkbox"/> Tone 2
Which service do you prefer when a calling party is recording a message in your mailbox? (Live Call Screening [LCS] Mode Set)	<input type="checkbox"/> <input type="text" value="1"/> <input type="text" value="1"/>	<input type="checkbox"/> You can monitor the message through the telephone speaker. <b>(Hands-free mode)</b>
	<input type="checkbox"/> <input type="text" value="1"/> <input type="text" value="2"/>	<input type="checkbox"/> Only an alert tone is heard. <b>(Private mode)</b>



- \* If there are only 3 lines in the PBX, outside (CO) line numbers 4 through 8 cannot be used.



- After the programme number is entered, the programme title and the selection are displayed.
- After you have changed a setting, one beep is heard. If the setting was invalid, 3 beeps are heard.

#### ◆◆ Clearing Features

You can reset the following features to their default settings.

This operation also cancels the AUTO ANS/MUTE status of both the Hands-free Answerback feature and the Room Monitor feature.

Feature	Default Setting
Line Preference—Outgoing	<b>No line</b>
Line Preference—Incoming	<b>A ringing line</b>
Outside (CO) Line Ringing Selection	<b>Ring—all outside (CO) lines</b>
Alternate Receiving—Ring/Voice	<b>Ring</b> (Tone Call)
Call Waiting Tone Type Selection	<b>Tone 1</b>

### To return features to default (Personal Programming Data Reset)

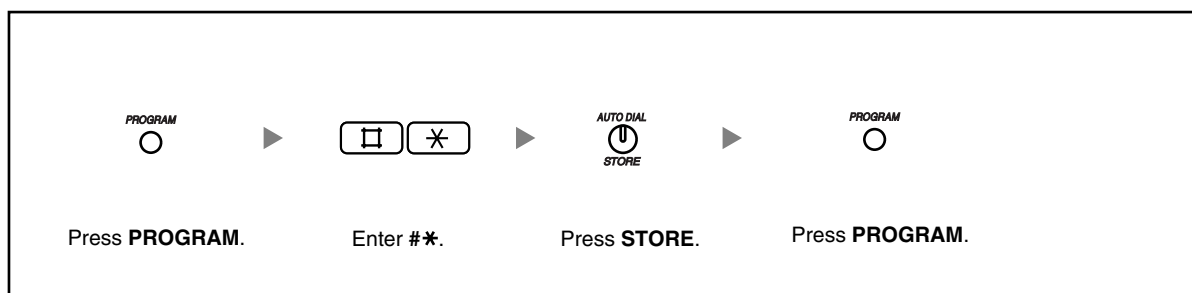

### ◆◆ Confirming Your Own Extension Number (Self-extension Number Confirmation)

You can confirm your jack and extension number.

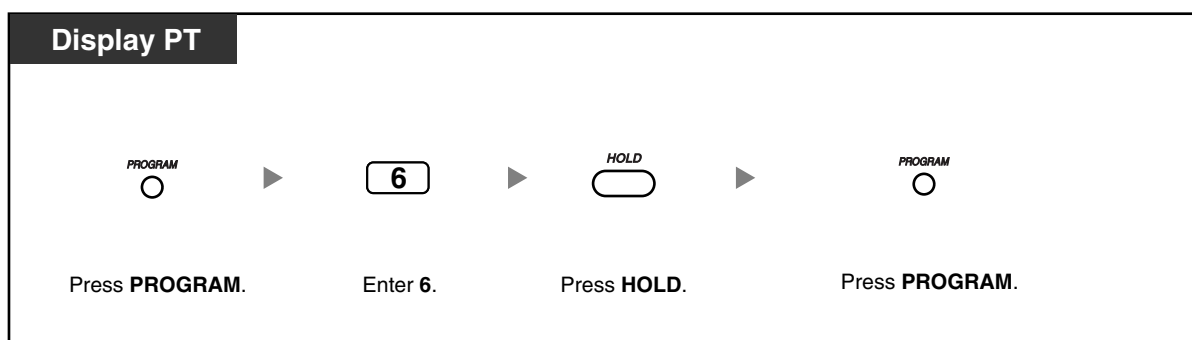

- You can also confirm your extension number by pressing the "\*" key 2 times ("\* \*") while on-hook. Every time you press the "\*" key, the display switches between "date (month [day], day [month]) and time", "date (month [day], day [month], year, day of the week)", and "extension number (and extension name if stored)".

### 3.1.3 Customising the Buttons

You can customise the flexible CO buttons, Direct Station Selection (DSS) buttons, Programmable Feature (PF) buttons, and MESSAGE buttons on your proprietary telephone (PT) and DSS Console by assigning the following features to them. For example, if your telephone has more CO buttons than the number of outside (CO) lines connected to your PBX, you can customise unused CO buttons by assigning them to be One-touch Dialling buttons.

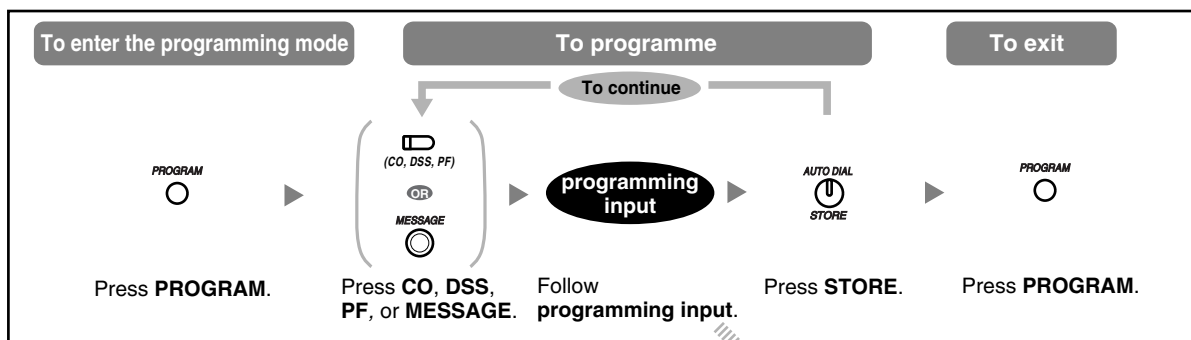

Button	Programmable Button				Programming Input
	CO	DSS	PF	MESSAGE	
Single-CO (S-CO)	✓				[0] + outside (CO) line no. (1–8)*1
Group-CO (G-CO)	✓				[☐] + outside (CO) line group no. (1–8)*1
Other-CO (O-CO)	✓				[*]
Direct Station Selection (DSS)	✓	✓		✓	[1] + extension no.*1
One-touch Dialling*2	✓	✓	✓	✓	[2]*3 + desired no.*1 (max. 24 digits)
Conference	✓				[3]
Message*4				✓	[3]
FWD/DND (Call Forwarding/Do Not Disturb)	✓				[4]
Day*5		✓			[4]
Save	✓				[5]
Night*5		✓			[5]
Caller ID Indication—Personal	✓				[6]
Lunch*5		✓			[6]
Caller ID Selection—Personal	✓				[7]

Button	Programmable Button				Programming Input
	CO	DSS	PF	MESSAGE	
Extension Lock* <sup>5</sup>		✓			[7] + extension no.* <sup>1</sup>
Log-in/Log-out	✓				[8]
2-way Record* <sup>6</sup>	✓	✓			[9] [0] + voice mail extension no.* <sup>1</sup>
2-way Transfer* <sup>6</sup>	✓	✓			[9] [1] + voice mail extension no.* <sup>1</sup>
Live Call Screening (LCS)* <sup>6</sup>	✓	✓			[9] [2]
LCS Cancel* <sup>6</sup>	✓	✓			[9] [3]
Voice Mail (VM) Transfer* <sup>6</sup>	✓	✓			[9] [4] + voice mail extension no.* <sup>1</sup>
Message for Another Extension	✓	✓			[9] [5] + extension no.* <sup>1</sup>
Caller ID Indication—Common	✓				[9] [6]
Caller ID Selection—Common	✓				[9] [7]



- \*<sup>1</sup> To erase an incorrect entry, press the TRANSFER (CLEAR) button. The TRANSFER button becomes the CLEAR button during programming.
- \*<sup>2</sup> Digits "0 through 9", "\*", "#", PAUSE, and SECRET (INTERCOM) can be stored. If you do not want to display the stored number when making a call, press the SECRET (INTERCOM) button before and after the numbers you wish to conceal. If you store an outside party's number, you should first store an outside (CO) line access number (9/0\*, 81–88). If you need to enter an account code when making outside (CO) line calls, you can enter the feature number and specified account code after the outside (CO) line access number. <Example>

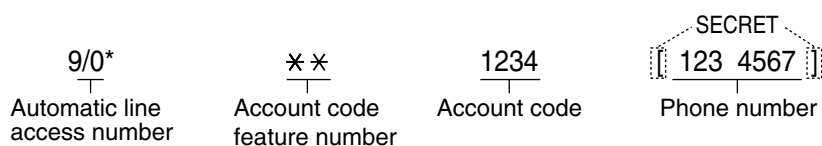

\* For New Zealand: 1 or 9

- \*<sup>3</sup> For a PF button, "2" need not be entered before the desired number.
- \*<sup>4</sup> Allows you to restore the Message Waiting feature to the Message button.
- \*<sup>5</sup> This button is only available for the operator/manager.
- \*<sup>6</sup> This button is used for Voice Mail Integration features.

### 3.1 Customising Your Phone (Personal Programming)



- You can programme DSS and PF buttons only from the paired PT.

#### To confirm a button setting

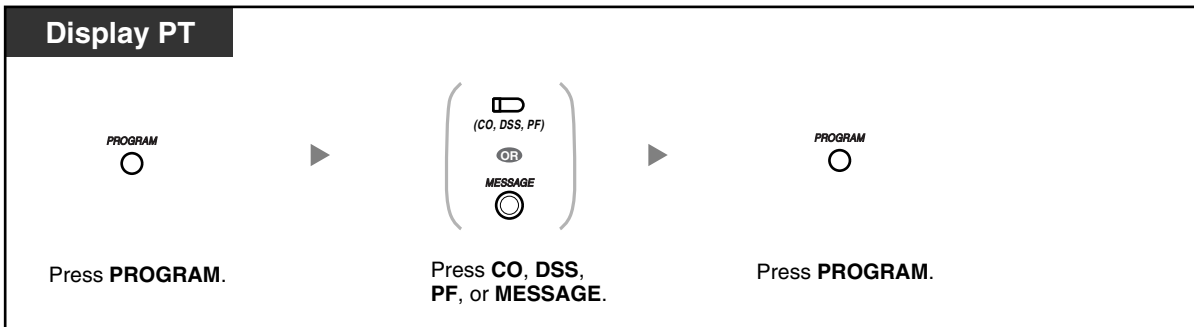

#### To clear a button setting

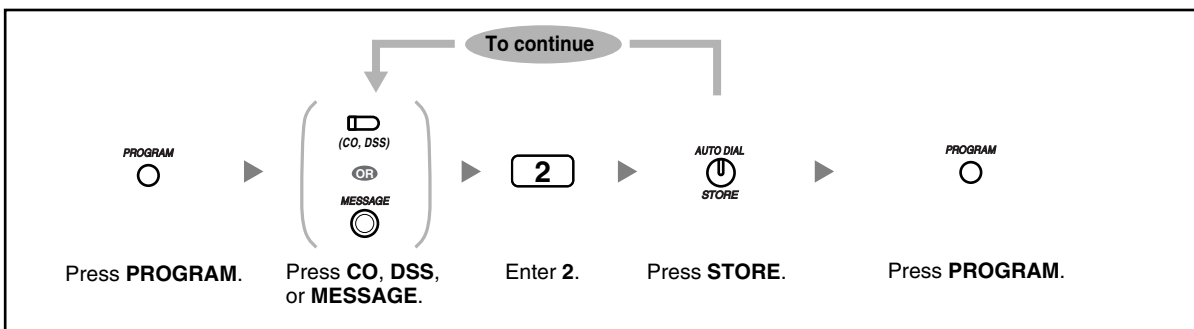

## 3.2 Managing Call Logs and Call Charges

### 3.2.1 Requirements

The manager can programme the following items.

- Call Logs
- Call Charges

#### **Available Extension**

The extension connected to extension jack 01

#### **Required Telephone**

A Panasonic proprietary telephone (PT) with a display (e.g., KX-T7730)

#### **Manager Password**

To enter programming mode, the manager password (the password of the extension connected to extension jack 01) is required. You can enter the system password instead of the manager password. Ask your administrator or dealer for the manager password or system password.

#### **Conditions**

In order to perform programming, your extension must be idle, on-hook, and holding no calls. System programming is required for managing call charges.

### 3.2.2 Managing Call Logs and Call Charges

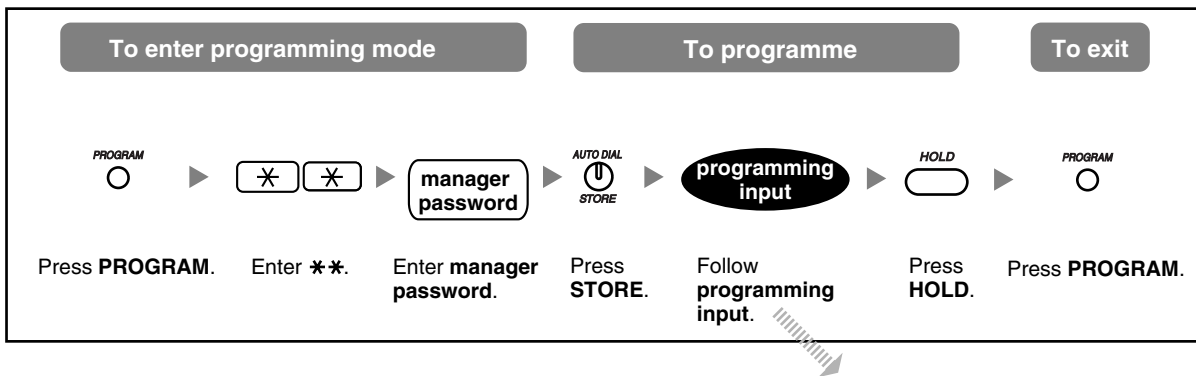

Item	Programming Input
Viewing the call charges of each extension.	<b>1</b> + extension no. <sup>*1</sup>
Clearing the call records and call charges of each extension. <sup>*2</sup>	<b>1</b> + extension no. <sup>*1</sup> + <b>TRANSFER</b> (circle) + <b>AUTO DIAL *1 STORE</b> (circle with vertical line)
Printing the call records and call charges of each extension.	<b>1</b> + extension no. <sup>*1</sup> + <b>AUTO DIAL *1 STORE</b> (circle with vertical line)
Viewing outside (CO) line call charges.	<b>2</b> + outside (CO) line no. <sup>*1</sup>
Clearing outside (CO) line call charges. <sup>*2</sup>	<b>2</b> + outside (CO) line no. <sup>*1</sup> + <b>TRANSFER</b> (circle) + <b>AUTO DIAL *1 STORE</b> (circle with vertical line)
Viewing call charges for each account code.	<b>3</b> + account code <sup>*1</sup>
Clearing call charges for each account code. <sup>*2</sup>	<b>3</b> + account code <sup>*1</sup> + <b>TRANSFER</b> (circle) + <b>AUTO DIAL *1 STORE</b> (circle with vertical line)
Clearing all call records and call charges for all extensions.	<b>5</b> + <b>AUTO DIAL *3 STORE</b> (circle with vertical line)
Printing call charge information.	<b>6</b> + <b>SP-PHONE</b> (circle with horizontal line) <sup>*4</sup> + <b>AUTO DIAL *3 STORE</b> (circle with vertical line)
Setting the budget limit for each extension.	<b>7</b> + extension no. <sup>*1</sup> + charge limitation <sup>*5</sup> + <b>AUTO DIAL *1 STORE</b> (circle with vertical line)
Clearing the budget limit for each extension.	<b>7</b> + extension no. <sup>*1</sup> + <b>TRANSFER</b> (circle) + <b>AUTO DIAL *1 STORE</b> (circle with vertical line)





- \*1 To move to the next or previous number or code, press the SP-PHONE (NEXT) or REDIAL (PREV) button respectively. To move to another number or code, press the AUTO ANS/MUTE button one time and dial the desired number. To move to another setting, press the AUTO ANS/MUTE button 2 times.
- \*2 To confirm the cleared date and time, press the FWD/DND (Call Forwarding/Do Not Disturb) or MESSAGE button. To return to the previous display, press the same button again.
- \*3 To move to another setting, press the AUTO ANS/MUTE button one time.
- \*4 To select the desired parameter (each extension, each outside (CO) line, each account code or all), press the SP-PHONE (NEXT) button until the desired parameter is displayed.
- \*5 The charge limitation can consist of up to 10 digits.
- The display can show a maximum of 12 digits, including the decimal point, for the total of call charges (for each extension, outside (CO) line, account code). If the total exceeds 12 digits, it is displayed from the first number and decimal digits that cannot be displayed are rounded up.

## 3.3 Customising Your PBX (System Programming)

### 3.3.1 Programming Information

You can change the default settings of your PBX according to your requirements.

**Customisable programming items are shown below, with the programme number in parentheses.**

- System Speed Dialling Number [001]
- System Speed Dialling Name [011]
- DISA Security Code [512]
- DISA Security Code Digits [530]

#### Available Extension

The extension connected to extension jack 01

#### Required Telephone

A Panasonic proprietary telephone (PT) with a display (e.g., KX-T7730)

#### Manager Password

To enter programming mode, the manager password (the password of the extension connected to extension jack 01) is required. You can enter the system password instead of the manager password. Ask your administrator or dealer for the manager password or system password.

















#### Conditions

In order to perform programming, your extension must be idle, on-hook, and holding no calls.

#### List

Before programming, decide the settings and write them down. Your notes will provide a useful record of the programming for future reference. Your dealer also has programming records that contain all dealer-performed system programming. If necessary, you can request copies of these records to confirm the available facilities and features.

## ◆◆ Icon Descriptions

Fixed Button (KX-T7730/KX-T7735)	Function
	PREV (PREVIOUS)
	NEXT
	
	 , -
	- , 
	SECRET
	STORE
	PAUSE
	PROGRAM
	END
	SELECT
	FLASH
	CLEAR

#### ◆◆ Procedure

The basic steps are shown below.

##### 1. To enter programming mode

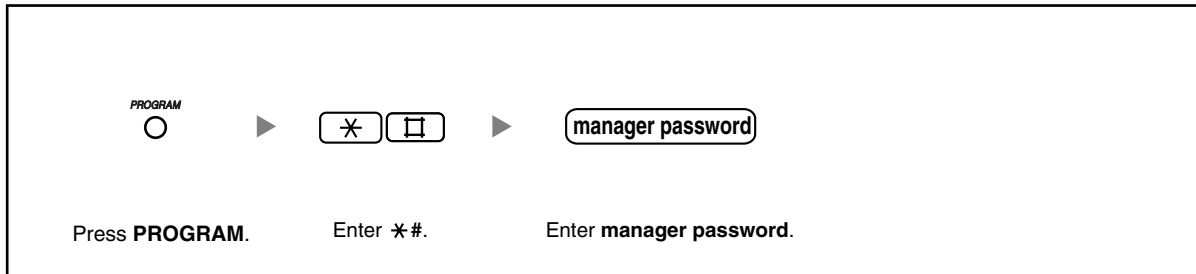

##### 2. To programme

You can enter each programme number (3 digits).

##### 3. To exit programming mode

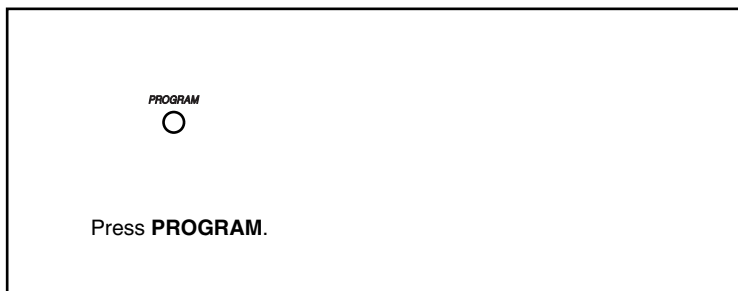

## 3.3.2 System Programming

### ◆◆ System Speed Dialling Number [001]

You can store frequently used phone numbers for convenient dialling.

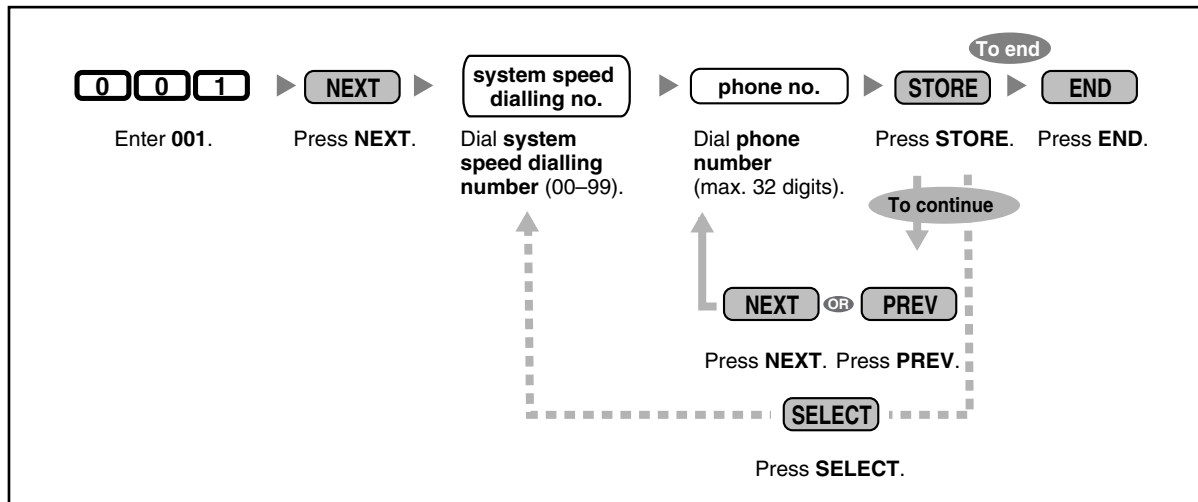

- If the desired number is more than 32 digits, divide the number and store it into more than one speed dialling number.
- "\*", "#", FLASH/RECALL, PAUSE, SECRET (INTERCOM), and "- (CONF)" can also be stored.
- If you do not want to display the stored number when making a call, press the SECRET (INTERCOM) button before and after the numbers you wish to conceal.

If you store an outside party's number, you should first store an outside (CO) line access number (9/0\*, 81-88).

If you need to enter an account code when making outside (CO) line calls, you can enter the feature number and specified account code after the outside (CO) line access number.

<Example>

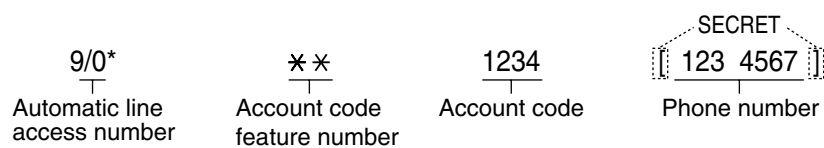

\* For New Zealand: 1 or 9

### ◆◆ System Speed Dialling Name [011]

You can store the name associated with each speed dialling number. These names are displayed when making calls using the System Speed Dialling feature. To enter characters, refer to "Entering Characters".

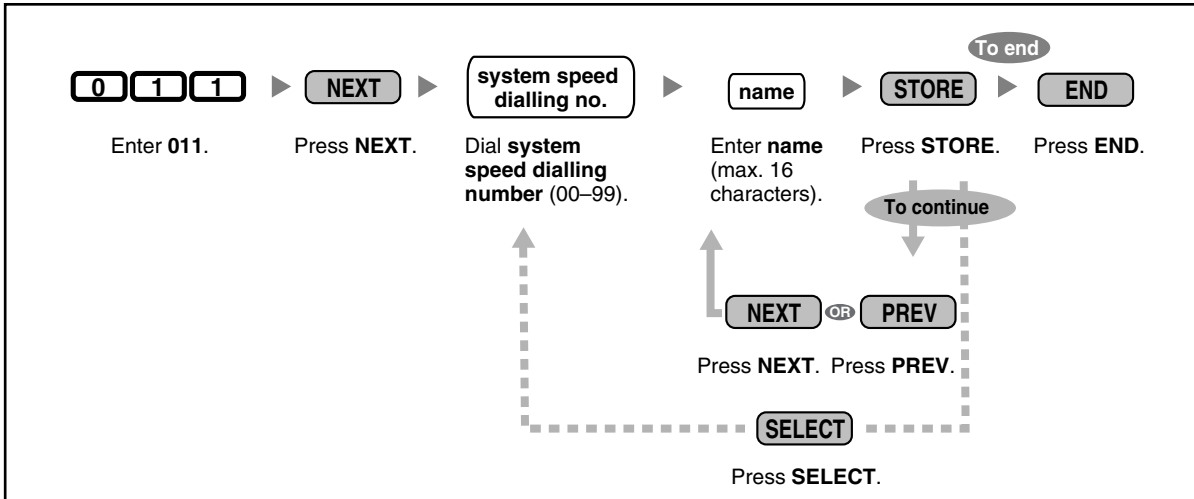

### ◆◆ DISA Security Code [512]

You can assign required Direct Inward System Access (DISA) security codes if "Trunk Security" or "All Security" is selected in DISA Security Mode [511].

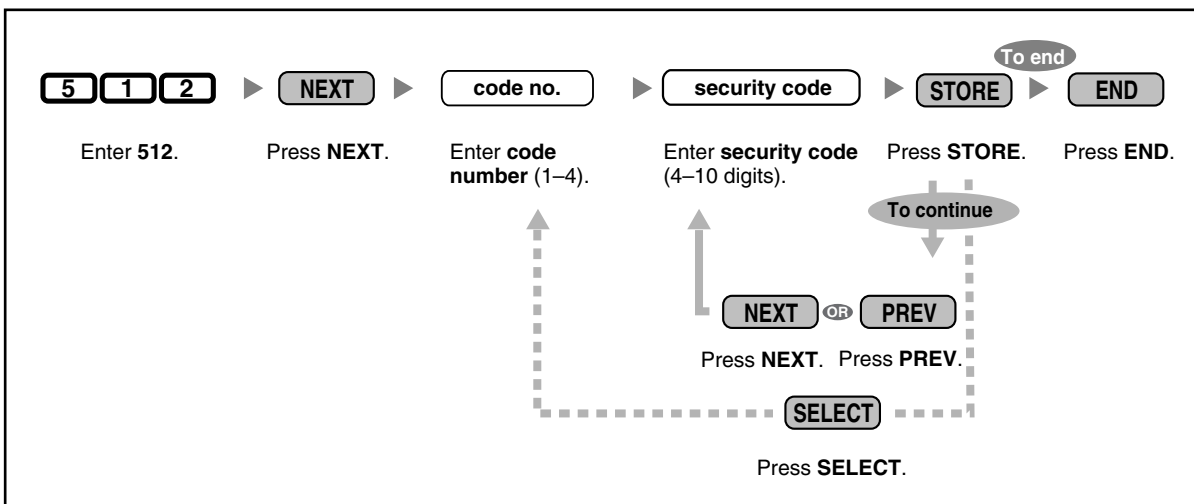



- **WARNING**

There is a risk that fraudulent telephone calls will be made using the Outside-to-Outside (CO-to-CO) Line Call feature of DISA.

The cost of such calls will be billed to the owner/renter of the PBX.

To protect the PBX from this kind of fraudulent use, we strongly recommend:

- Enabling DISA security (Trunk Security or All Security).
  - Keeping DISA security codes secret.
  - Selecting complex, random codes that cannot be easily guessed.
  - Changing codes regularly.
- Security code numbers (not security codes) are logged by Station Message Detail Recording (SMDR).
  - The number of digits required for DISA security codes can be assigned in DISA Security Code Digits [530].

### ◆◆ DISA Security Code Digits [530]

You can select the number of digits used for DISA security codes assigned in DISA Security Code [512].

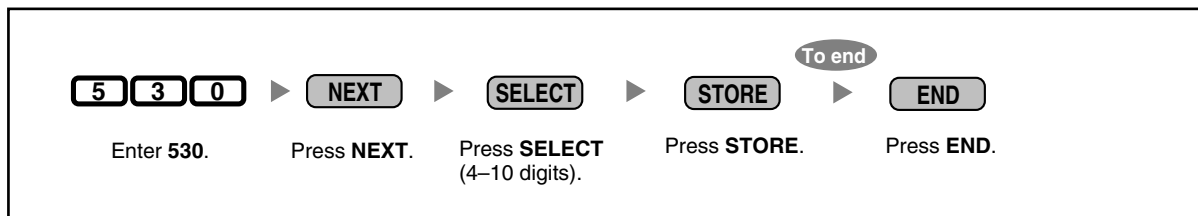

- When this setting is changed, all assigned DISA security codes are cleared.

## ◆◆ Entering Characters

You can enter the following characters. The tables below show you the characters available for each button.

**Table 1 (Alphabet mode)/Table 2 (Numeral mode)**

Buttons	Times								Buttons	Times
	1	2	3	4	5	6	7	8		1
1	!	?	"							1
2	A	B	C	a	b	c				2
3	D	E	F	d	e	f				3
4	G	H	I	g	h	i				4
5	J	K	L	j	k	l				5
6	M	N	O	m	n	o				6
7	P	Q	R	S	p	q	r	s		7
8	T	U	V	t	u	v				8
9	W	X	Y	Z	w	x	y	z		9
0	(Space)	.	,	'	:	;				0
*	/	+	-	=	<	>				*
□	\$	%	&	@	(	)				□

<Example> To enter "Ann",

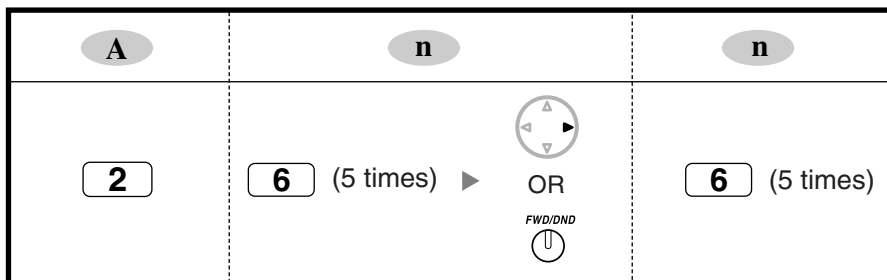

### Notes

- To toggle between "Alphabet mode" and "Numeral mode", press SELECT.
- To move the cursor right, press .
- To delete all characters, press CLEAR. To delete a character, press .



---





## **Section 4**

### **Appendix**















*This chapter provides Troubleshooting, the Feature Number Table and Tone List. Check the Troubleshooting section before consulting your dealer.*

## 4.1 Troubleshooting

### 4.1.1 Troubleshooting

Problem	Remedy
I cannot make calls using the telephone.	<ul style="list-style-type: none"> <li>• <b>The telephone is locked.</b> <ul style="list-style-type: none"> <li>➤ Unlock your telephone. (  1.5.3 Preventing Other People from Using Your Telephone (Extension Lock), 2.1.1 Locking Other Extensions (Remote Extension Lock))</li> </ul> </li> </ul>
Some features do not function.	<ul style="list-style-type: none"> <li>• <b>System management may restrict certain features.</b> <ul style="list-style-type: none"> <li>➤ Consult your manager or dealer.</li> </ul> </li> </ul>
I cannot make calls to other extensions using a proprietary telephone (PT).	<ul style="list-style-type: none"> <li>• <b>An idle or assigned outside (CO) line is being seized.</b> The line seized when going off-hook was changed in personal settings. (  3.1.2 Changing Personal Settings Using Programming Mode) <ul style="list-style-type: none"> <li>➤ If this setting has been changed, press the INTERCOM button after going off-hook, and then follow the instructions.</li> </ul> </li> </ul>
My new telephone does not function correctly.	<ul style="list-style-type: none"> <li>• <b>The previous extension's settings have not been cleared.</b> <ul style="list-style-type: none"> <li>➤ Clear the settings and then programme your desired settings again. (  1.7.8 Clearing Features Set at Your Extension (Extension Feature Clear), 3.1.2 Changing Personal Settings Using Programming Mode, 3.1.3 Customising the Buttons)</li> </ul> </li> </ul>
My PT does not have the button needed to perform a certain operation.	<ul style="list-style-type: none"> <li>• <b>Some models do not have certain feature buttons.</b> <ul style="list-style-type: none"> <li>➤ Customise a flexible button to function as the desired button. (  3.1.3 Customising the Buttons)</li> <li>➤ Enter the specified feature number instead of pressing the feature button. (  1.1.1 Before Operating a Telephone)</li> </ul> </li> </ul>

Problem	Remedy
<p>When I try to make an outside (CO) line call, I hear a reorder tone, or the display shows "Restricted".</p>	<ul style="list-style-type: none"> <li>• <b>The telephone is locked.</b> <ul style="list-style-type: none"> <li>➤ Unlock your telephone. (👉 1.5.3 Preventing Other People from Using Your Telephone (Extension Lock), 2.1.1 Locking Other Extensions (Remote Extension Lock))</li> </ul> </li> <li>• <b>Toll Restriction (TRS) is activated.</b> <ul style="list-style-type: none"> <li>➤ Consult your manager or dealer.</li> </ul> </li> <li>• <b>An account code is required.</b> (👉 1.2.6 Using Your Calling Privileges at Another Extension (Walking COS), Using an Account Code (Account Code Entry) in 1.2.1 Basic Calling)</li> <li>• <b>CO Busy Out is activated.</b> <ul style="list-style-type: none"> <li>➤ Press the Single-CO (S-CO) button to re-enable an outside (CO) line. If problems persist, consult your manager or dealer.</li> </ul> </li> <li>• <b>The preprogrammed budget limit has been reached.</b> (👉 1.2.1 Basic Calling) <ul style="list-style-type: none"> <li>➤ Consult your manager or dealer to extend the limit, if necessary.</li> </ul> </li> </ul>
<p>I cannot make an outside (CO) line call using a One-touch Dialling button or Speed Dialling.</p>	<ul style="list-style-type: none"> <li>• <b>An outside (CO) line access number was not stored with the phone number.</b> <ul style="list-style-type: none"> <li>➤ An outside (CO) line access number is required for outside (CO) line calls. (👉 1.2.1 Basic Calling, 3.1.3 Customising the Buttons)</li> </ul> </li> </ul>
<p>During a conversation with an outside party, the call was disconnected.</p>	<ul style="list-style-type: none"> <li>• <b>The specified time limit has run out.</b> (👉 1.2.1 Basic Calling, 1.4.1 Transferring a Call (Call Transfer), 1.4.5 Talking to Multiple Parties (Conference)) <ul style="list-style-type: none"> <li>➤ Consult your manager or dealer about extending the time limit, if necessary.</li> </ul> </li> </ul>
<p>The Redial feature does not function.</p>	<ul style="list-style-type: none"> <li>• <b>The stored number is more than 64 digits long, or is an extension number.</b> (👉 1.2.3 Redialling) <ul style="list-style-type: none"> <li>➤ Redialling can only be used with outside (CO) line numbers of 64 digits or less.</li> </ul> </li> </ul>
<p>I cannot access computer services, telephone banking, etc.</p>	<ul style="list-style-type: none"> <li>• <b>A tone signal is required and your outside (CO) line is set to "Pulse".</b> (👉 1.4.9 Changing the Dialling Mode (Pulse to Tone Conversion)) <ul style="list-style-type: none"> <li>➤ Change the dialling mode.</li> </ul> </li> </ul>
<p>Computer or fax machine communication was interrupted.</p>	<ul style="list-style-type: none"> <li>• <b>An indication tone may have interrupted communication.</b> (👉 1.7.6 Protecting Your Line against Notification Tones (Data Line Security)) <ul style="list-style-type: none"> <li>➤ Set your line to not receive signalling tones.</li> </ul> </li> </ul>

Problem	Remedy
<p><b>I cannot send a call waiting tone to the dialled extension.</b></p>	<ul style="list-style-type: none"> <li>• <b>The other party has not set the Call Waiting feature.</b> (  Sending a Call Waiting Tone to a Busy Extension (Busy Station Signalling [BSS]), 1.4.4 Answering Call Waiting, 1.7.3 Receiving Call Waiting)</li> <li>• <b>The other party has set Data Line Security.</b> (  1.7.6 Protecting Your Line against Notification Tones (Data Line Security))</li> </ul>
<p><b>I forgot my extension password.</b></p>	<ul style="list-style-type: none"> <li>•  Ask your manager to assist you. (  2.1.7 Changing System Settings Using Programming Mode)</li> </ul>
<p><b>Music started playing through the telephone's speaker.</b></p>	<ul style="list-style-type: none"> <li>• <b>This is Background Music (BGM).</b> (  1.7.5 Turning on the Background Music (BGM)) <ul style="list-style-type: none"> <li> Turn off the music by entering "1" while on-hook.</li> <li> Ask your manager or dealer to set your extension not to play music when "1" is entered while on-hook.</li> </ul> </li> </ul>
<p><b>I want to prevent a number that is stored in memory from being displayed when making a call.</b></p>	<ul style="list-style-type: none"> <li>•  Conceal the number. (  3.1.3 Customising the Buttons)</li> </ul>
<p><b>I want to confirm my extension number.</b></p>	<ul style="list-style-type: none"> <li>•  Confirm your extension number by pressing the "*" key 2 times while on-hook, or through personal programming. (  Your Extension Number in 1.1.1 Before Operating a Telephone, 3.1.2 Changing Personal Settings Using Programming Mode)</li> </ul>
<p><b>The date and/or time are not correct.</b></p>	<ul style="list-style-type: none"> <li>•  Ask your operator or manager to change the date or time. (  Date &amp; Time Set in 2.1.7 Changing System Settings Using Programming Mode)</li> </ul>
<p><b>The display is dim.</b></p>	<ul style="list-style-type: none"> <li>•  Change the display contrast level. (  1.1.1 Before Operating a Telephone)</li> </ul>
<p><b>The MESSAGE/Message button light or Message/Ringer Lamp is lit.</b></p>	<ul style="list-style-type: none"> <li>• <b>There are 3 possible reasons:</b> (1) <b>Someone has left a message waiting indication for you,</b> (2) <b>Someone has left a Built-in Voice Message (BV) for you, or</b> (3) <b>Someone has left a Voice Mail message for you.</b> <b>Press the MESSAGE/Message button to call the party back or receive the message.</b></li> </ul>

Problem	Remedy
"Voice Msg Full" is displayed.	<ul style="list-style-type: none"> <li>• <b>The maximum voice message recording time has been reached.</b> <ul style="list-style-type: none"> <li>➤ Delete voice messages stored in your personal message area or in the common message area.</li> <li>➤ It may take about 10 seconds for the display to return to the idle status display even if the remaining recording time becomes 5 minutes or more.</li> </ul> </li> </ul> <p>(  1.5.5 Using Voice Messaging (Built-in Voice Message [BV]))</p>
A power failure has occurred.	<ul style="list-style-type: none"> <li>• <b>When a power failure occurs...</b> All functions of the PBX and Panasonic PTs stop. The following outside (CO) lines will be connected to the assigned SLTs: Outside (CO) line 1: extension jack 01 Outside (CO) line 4: extension jack 09 Outside (CO) line 7: extension jack 17 This allows outside (CO) line conversations between the specified SLTs and outside destinations.</li> <li>• <b>When the power is turned back on...</b> Your PBX restarts with the stored data automatically. Memory is protected by a factory-provided lithium battery. There is no memory loss except for the data associated with Automatic Callback Busy, Redial, and Call Park.</li> </ul>

## 4.2 Feature Number Table

### 4.2.1 Feature Number Table

The numbers listed below are the feature numbers used to access the PBX features. The numbering plan can be selected through system programming. Numbers in parentheses indicate that the feature numbers are different from those of "Plan 1" when "Plan 2" or "Plan 3" is selected.

Feature (While a dial tone is heard)	Numbering	Additional Number
<b>1.2.1 Basic Calling</b> To call another extension (Intercom Call)  To call the operator (Operator Call)  To select an idle outside (CO) line automatically (Automatic Line Access)  To select an idle outside (CO) line in the specified outside (CO) line group automatically (Outside (CO) Line Group Access)  Using an Account Code (Account Code Entry)	100–199 (100–499 or 10–49) <sup>*1</sup>  0/9  9/0 <sup>*2</sup>  8  ××/49 (××)	   outside phone no.  outside (CO) line group no. (1–8) + outside phone no.  account code + outside phone no.
<b>1.2.2 Easy Dialling</b> Using Numbers Stored at Your Extension (Personal Speed Dialling) <ul style="list-style-type: none"> <li>– To store</li> <li>– To dial</li> <li>– To confirm</li> </ul> Using Numbers Stored in the PBX (System Speed Dialling) <ul style="list-style-type: none"> <li>– To dial</li> </ul> Dialling a Preset Number by Going Off-hook (Hot Line) <ul style="list-style-type: none"> <li>– To store</li> <li>– To set</li> <li>– To cancel</li> </ul>	2×  1×/# (1×/##)  3×  ×  74	  personal speed dialling no. (0–9) + phone no. + #  personal speed dialling no. (0–9)  personal speed dialling no. (0–9) + #  system speed dialling no. (00–99)  2 + phone no. + # 1 + #/0 0 + #/0
<b>1.2.3 Redialling</b> Redialling the Last Outside Number You Dialed (Last Number Redial)	80/## (80/###)	

Feature (While a dial tone is heard)	Numbering	Additional Number
<p>1.2.4 When the Dialed Party is Busy or There is No Answer</p> <p>Leaving a Message Waiting Indication/Calling Back a Caller Who Left an Indication (Message Waiting)</p> <p>Leaving a Message Waiting Indication</p> <ul style="list-style-type: none"> <li>– To leave</li> <li>– To cancel</li> </ul> <p>Calling Back a Caller Who Left an Indication</p> <ul style="list-style-type: none"> <li>– To cancel all indications left at your extension</li> <li>– To cancel all indications left at another extension</li> <li>– To lock indications left at your extension</li> <li>– To unlock indications left at your extension</li> </ul>	70	<p>1 + extension no. + #/0</p> <p>2 + extension no. + #/0</p> <p>0 + #/0</p> <p>3 + extension no. + #</p> <p>4-digit (4000–9999) lock code 2 times + #/0</p> <p>stored lock code + #/0</p>
1.2.6 Using Your Calling Privileges at Another Extension (Walking COS)	7*	extension password + your extension no. + #/0
<p>1.3.3 Answering a Call Ringing at Another Telephone (Call Pickup)</p> <p>Answering a Call from Another Telephone (Call Pickup)</p> <ul style="list-style-type: none"> <li>– Group Call Pickup</li> <li>– Directed Call Pickup</li> </ul> <p>Preventing Other People from Picking Up Your Calls (Call Pickup Deny)</p> <ul style="list-style-type: none"> <li>– To prevent</li> <li>– To allow</li> </ul>	<p>40 (#40)</p> <p>4 (#41)</p> <p>72</p>	<p>extension no.</p> <p>1 + #/0</p> <p>0 + #/0</p>
<p>1.4.2 Holding a Call</p> <p>To retrieve a call (Call Hold Retrieve)</p> <ul style="list-style-type: none"> <li>– To retrieve an outside (CO) line call</li> <li>– To retrieve an intercom call</li> </ul>	<p>53 (#59)</p> <p>5 (#5)</p>	<p>no. (1–8) of outside (CO) line being held</p> <p>extension no. that put the call on hold</p>

## 4.2 Feature Number Table

Feature (While a dial tone is heard)	Numbering	Additional Number
Holding in a System Parking Zone (Call Park) <ul style="list-style-type: none"> <li>– To park a call</li> <li>– To retrieve</li> </ul>	22 (#22) <sup>*3</sup>  52 (#56) <sup>*4</sup>	parking zone no. (0–9)  stored parking zone no. (0–9)
1.4.4 Answering Call Waiting Answering Call Waiting from the Telephone Company	6	
1.4.5 Talking to Multiple Parties (Conference) Originating a 3-party to 5-party Conference Call (5-party Conference)	22* (#22*)	(phone no. + CONF) 4 times + CONF
1.5.1 Forwarding Your Calls (Call Forwarding [FWD])/1.7.2 Refusing Incoming Calls (Do Not Disturb [DND])	71	0 (Cancel) + #/0 1 (All Calls) + extension no. + #/0 2 (Busy/No Answer) + extension no. + #/0 3 (To Outside (CO) Line) + outside (CO) line access no. + outside phone no. + # 4 (Do Not Disturb [DND]) + #/0 5 (Follow Me) + your extension no. + #/0 8 (Follow Me Cancel) + your extension no. + #/0
1.5.2 Showing a Message on the Caller's Telephone Display (Absent Message) <ul style="list-style-type: none"> <li>– To set</li> <li>– To cancel</li> </ul>	75	1–6 (+ parameter) + #/0 0 + #/0
1.5.3 Preventing Other People from Using Your Telephone (Extension Lock) <ul style="list-style-type: none"> <li>– To lock</li> <li>– To unlock</li> </ul>	77	4-digit lock code 2 times + #/0 stored lock code + #/0
1.5.4 Leaving a Group (Log-in/Log-out) <ul style="list-style-type: none"> <li>– To log in</li> <li>– To log out</li> </ul>	736	0 + #/0 1 + #/0



Feature (While a dial tone is heard)	Numbering	Additional Number
1.5.5 Using Voice Messaging (Built-in Voice Message [BV])		
Recording, Playing, or Erasing Personal BV Outgoing Messages	723	
– To record		1 + #/0
– To play back		2 + #/0
– To erase		0 + #/0
Forwarding Your Calls to Built-in Voice Message	71	
– To set		1 (All Calls) or 2 (Busy/No Answer) + 725 + #/0
– To cancel		0 (Cancel) + #/0
Leaving, Playing, or Erasing Voice Messages	725	
– To leave a voice message using Direct Message		1 + extension no. + #/0
– To play back all voice messages in a voice message area		2 + #/0
– To erase all voice messages in a voice message area		0 + #/0
1.6.1 Paging		
– All Extensions	33 (#33)	0
– Group	33 (#33)	extension group no. (1–8)
– External	34 (#34)	
– All Extensions & External	33 (#33)	× or 9
1.6.2 Answering/Denying a Paging Announcement		
– To answer	43 (#43)	
– To refuse	734	1 + #
– To accept	734	0 + #
1.7.1 Setting the Alarm (Timed Reminder)	76	
– To set		hour/minute + 0 (AM)/1 (PM) + 1 (one time)/2 (daily) + #/0
– To cancel		2 + #/0
– To confirm		3 + #

## 4.2 Feature Number Table

Feature (While a dial tone is heard)	Numbering	Additional Number
<b>1.7.3 Receiving Call Waiting</b> <ul style="list-style-type: none"> <li>– To set for outside (CO) line calls</li> <li>– To cancel for outside (CO) line calls</li> <li>– To set for intercom calls/doorphone calls</li> <li>– To cancel for intercom calls/doorphone calls</li> </ul>	731 731 732 732	1 + #/0 0 + #/0 1 + #/0 0 + #/0
<b>1.7.4 Preventing Other People from Joining Your Conversation (Executive Busy Override Deny)</b> <ul style="list-style-type: none"> <li>– To prevent</li> <li>– To allow</li> </ul>	733	0 + #/0 1 + #/0
<b>1.7.6 Protecting Your Line against Notification Tones (Data Line Security)</b> <ul style="list-style-type: none"> <li>– To set</li> <li>– To cancel</li> </ul>	730	1 + #/0 0 + #/0
<b>1.7.8 Clearing Features Set at Your Extension (Extension Feature Clear)</b>	79	#/0
<b>1.7.9 Monitoring a Room (Room Monitor)</b> <ul style="list-style-type: none"> <li>– To set</li> <li>– To cancel</li> <li>– To monitor through a doorphone</li> </ul>	735  31 (#31)	1 + # 0 + # doorphone no. (1–4) <sup>*5</sup>
<b>1.8.1 If a Doorphone/Door Opener is Connected</b> Calling to and from a Doorphone (Doorphone Call)  Opening a Door (Door Open)	31 (#31)  55 (#55)	doorphone no. (1–4) <sup>*5</sup>  door opener no. (1–4) <sup>*5</sup>
<b>1.8.2 If a Host PBX is Connected</b> Accessing External Services (External Feature Access [EFA])	6	
<b>1.8.3 If a Voice Processing System is Connected</b> Forwarding Your Calls to a Voice Processing System (Voice Mail Integration) <ul style="list-style-type: none"> <li>– To set</li> <li>– To cancel</li> <li>– To listen to messages</li> </ul>	71   784	1 (All Calls) or 2 (Busy/No Answer) + voice mail extension no. + #/0  0 (Cancel) + #/0  #/0

Feature (While a dial tone is heard)	Numbering	Additional Number
Screening Calls (Live Call Screening [LCS]) <ul style="list-style-type: none"> <li>– To set the LCS password</li> <li>– To cancel the LCS password</li> </ul>	77*	3-digit LCS password 2 times + # stored LCS password + #
1.9.1 Calling with the Incoming Call Log <ul style="list-style-type: none"> <li>– To erase all caller information in the personal area</li> <li>– To disregard the newest call in the personal area</li> <li>– To overwrite the oldest call in the personal area</li> <li>– To set logging of caller information when answering a call</li> <li>– To cancel logging of caller information when answering a call</li> </ul>	70*  737  737  738  738	#  0 + #  1 + #  1 (Personal area) or 2 (Common area) + #/0  0 (Cancel) + #/0
2.1.2 Switching the Time Service Mode (Time Service)* <sup>6</sup> <ul style="list-style-type: none"> <li>– To set (Day/Night/Lunch)</li> <li>– To cancel</li> </ul>	78	(1/2/3) + # 0 + #
2.1.3 Setting an Alarm for Other Extensions (Remote Timed Reminder [Wake-up Call])* <sup>6</sup> <ul style="list-style-type: none"> <li>– To set</li> <li>– To cancel</li> <li>– To confirm</li> </ul>	764	extension no. + # + 76 + hour/minute + 0 (AM)/1 (PM) + 1 (one time)/2 (daily) + # extension no. + # + 76 + 2 + # extension no. + # + 76 + 3 + #
2.1.4 Erasing All Caller Information in the Common Area (Incoming Call Log in the Common Area—CLEAR ALL)* <sup>6</sup> <ul style="list-style-type: none"> <li>– To erase</li> </ul>	70**	#
2.1.5 Disregarding the Newest Call or Overwriting the Oldest Call in the Common Area Call Log (301st Incoming Call Logged in the Common Area)* <sup>6</sup> <ul style="list-style-type: none"> <li>– To disregard the newest call</li> <li>– To overwrite the oldest call</li> </ul>	737	2 + # 3 + #

## 4.2 Feature Number Table

Feature (While a dial tone is heard)	Numbering	Additional Number
2.1.6 Recording, Playing, or Erasing Common BV Outgoing Messages* <sup>6</sup> <ul style="list-style-type: none"> <li>– To record</li> <li>– To play back</li> <li>– To erase</li> </ul>	722	common BV outgoing message (OGM) no. (01–24) + 1 + #/0 common BV OGM no. (01–24) + 2 + #/0 common BV OGM no. (01–24) + 0 + #/0



- \*<sup>1</sup> For United Kingdom/New Zealand: Plan 1: 200–299; for New Zealand: Plan 2: 200–499, Plan 3: 20–49
- \*<sup>2</sup> For New Zealand: 1 or 9
- \*<sup>3</sup> For United Kingdom/New Zealand: Plan 1: 36; Plan 2/Plan 3: #36
- \*<sup>4</sup> For United Kingdom/New Zealand: Plan 1: 56; Plan 2/Plan 3: #56
- \*<sup>5</sup> When using an optional 2-port doorphone card, select "1" and/or "3" (not "1" and/or "2") as the doorphone/door opener number.
- \*<sup>6</sup> This feature is only available for the operator/manager.

Feature (While a busy tone or DND tone is heard)	Numbering
1.2.4 When the Dialed Party is Busy or There is No Answer	
Sending a Call Waiting Tone to a Busy Extension (Busy Station Signalling [BSS])/ Calling an Extension That Is Refusing Calls (DND Override)	2
Joining an Existing Call (Executive Busy Override)	3
Reserving a Busy Line (Automatic Callback Busy [Camp-on])	6

Feature (While dialling or talking)	Numbering
1.2.5 Switching the Calling Method (Alternate Calling—Ring/Voice)	×
1.3.3 Answering a Call Ringing at Another Telephone (Call Pickup)	
– Call Retrieving from a Telephone Answering Machine (TAM)	4* <sup>1</sup>
1.4.9 Changing the Dialling Mode (Pulse to Tone Conversion)* <sup>2</sup>	×#
1.4.5 Talking to Multiple Parties (Conference)	3
Adding a Third Party During a Conversation (3-party Conference)	(#3)
1.8.1 If a Doorphone/Door Opener is Connected	5
From an extension that is on a call with a doorphone	



- \*<sup>1</sup> Dial after dialling the TAM's extension number and hearing a busy tone.
- \*<sup>2</sup> This feature is not available for users in Australia.

Feature (When the extension is on-hook)	Numbering
1.7.5 Turning on the Background Music (BGM) <ul style="list-style-type: none"> <li>– To set/cancel</li> </ul>	1
1.7.7 Checking the Time Service Mode/2.1.2 Switching the Time Service Mode (Time Service) <ul style="list-style-type: none"> <li>– To confirm the current mode</li> </ul>	#
3.1.2 Changing Personal Settings Using Programming Mode Confirming Your Own Extension Number (Self-extension Number Confirmation) <ul style="list-style-type: none"> <li>– To switch the display between "date (month [day], day [month]) and time", "date (month [day], day [month], year, day of the week)", and "extension number (and extension name if stored)"</li> </ul>	×

## 4.3 Identifying Tones

### 4.3.1 Identifying Tones

#### While On-hook

##### Ring Tone Patterns

The following ring tone patterns can be assigned to incoming call types (outside (CO) line, intercom, or doorphone calls), or are fixed for certain features (Hold Recall [outside (CO) line calls/intercom calls], Timed Reminder, or Camp-on Recall).

##### Single

- Selectable: outside (CO) line calls, intercom calls, doorphone calls
- Fixed: Hold Recall [outside (CO) line calls]



##### Double

- Selectable: outside (CO) line calls, intercom calls, doorphone calls
- Fixed: Hold Recall [intercom calls]



##### Triple

- Selectable: outside (CO) line calls, intercom calls, doorphone calls
- Fixed: Timed Reminder



##### S-Double

- Selectable: doorphone calls
- Fixed: Camp-on Recall

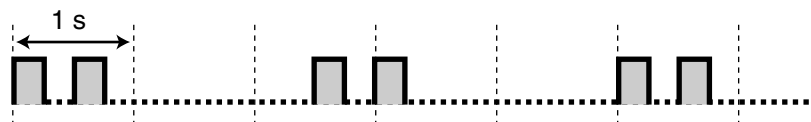

##### Note

The above tone patterns may vary depending on the system programming settings of your PBX.

### Ring Tone Patterns Sent from the Telephone Company (New Zealand only)

The following ring tone patterns sent from the telephone company can be detected for each outside (CO) line.

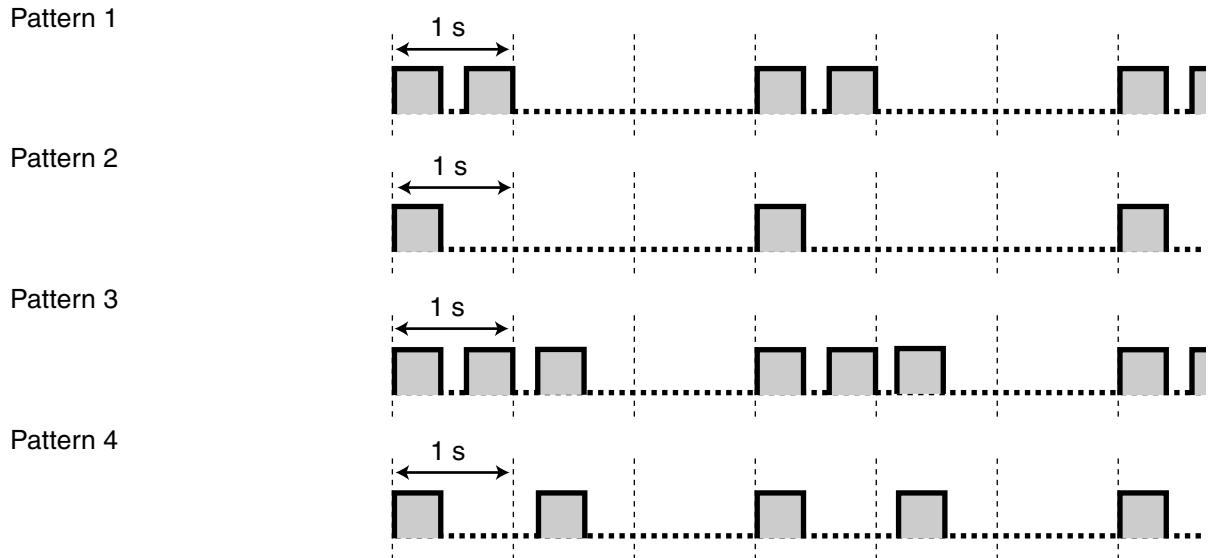

### Doorphone Chime Patterns

The following doorphone chime patterns can be assigned to each doorphone when doorbells and door chimes are connected to the PBX.

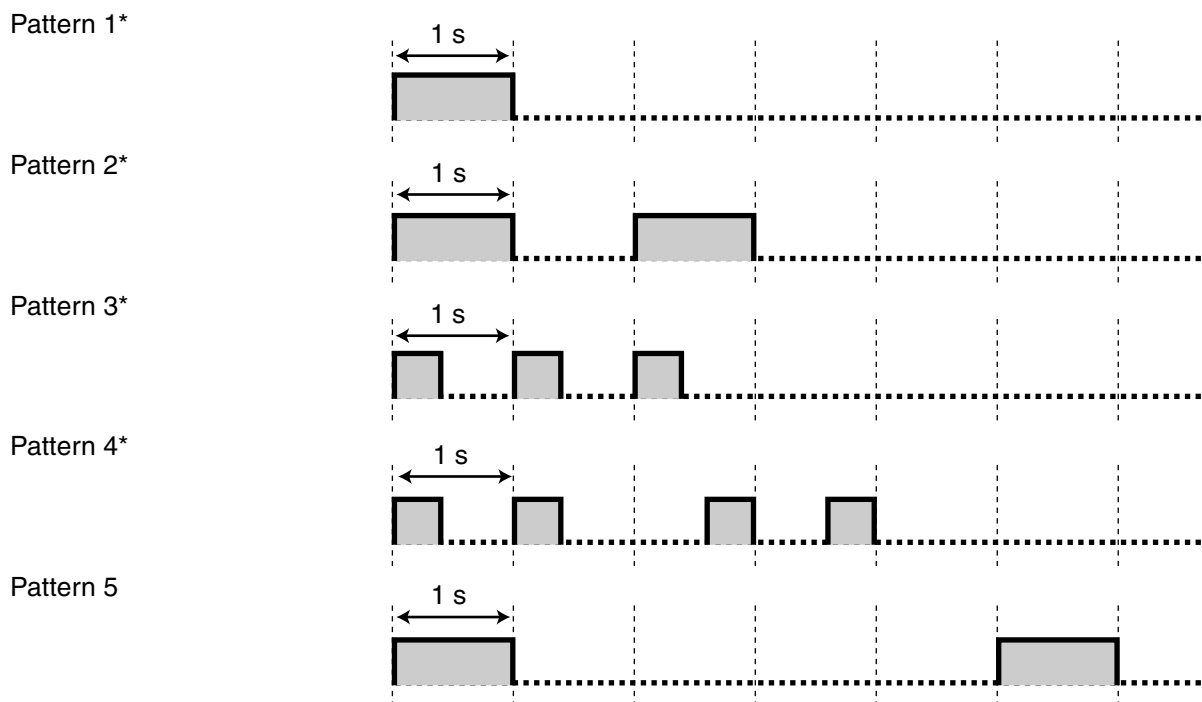

### 4.3 Identifying Tones

---

Pattern 6

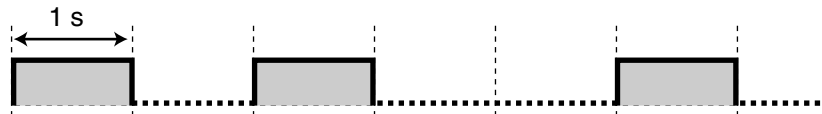

Pattern 7

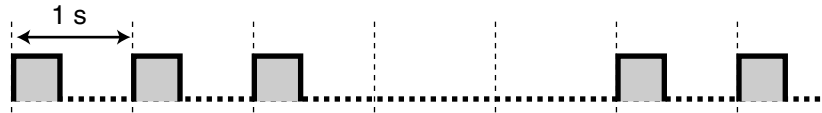

Pattern 8

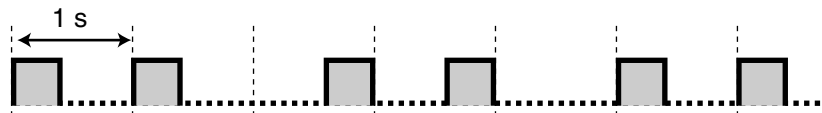

\* Chime patterns 1 to 4 are played only one time during the doorphone ringing time.



## When Going Off-hook

### Dial Tones

#### Tone 1

Normal



[Brazil only]



#### Tone 2

Any of the following features is set:

- Absent Message
- Background Music (BGM) (proprietary telephone [PT] only)
- Call Forwarding (FWD)
- Call Pickup Deny
- Data Line Security
- Do Not Disturb (DND)
- Extension Lock
- Hot Line (single line telephone [SLT] only)
- Message Waiting (PT only)
- Remote Extension Lock
- Timed Reminder



[Brazil only]

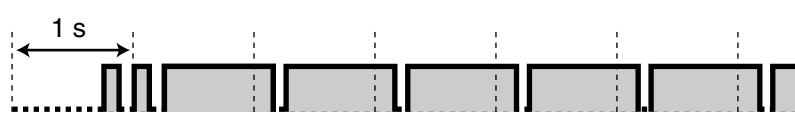

[Czech Republic only]



#### Tone 3

- When going off-hook with an SLT that has messages waiting
- When Account Code Entry is performed
- When answering a call from Timed Reminder



### 4.3 Identifying Tones

---

#### Tone 4

A new voice message has been recorded (Built-in Voice Message [BV]).

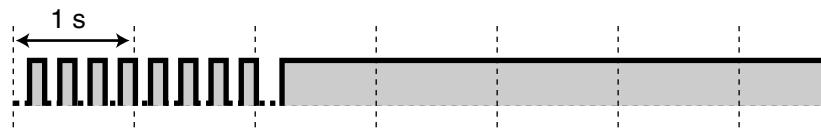

[Brazil only]



#### Tone 5

The remaining voice message recording time is less than 5 minutes or 125 voice messages have been recorded (Built-in Voice Message [BV]).



[Brazil only]



## When Making Calls

### Busy Tones

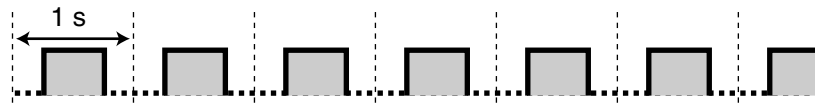

[Australia/New Zealand only]

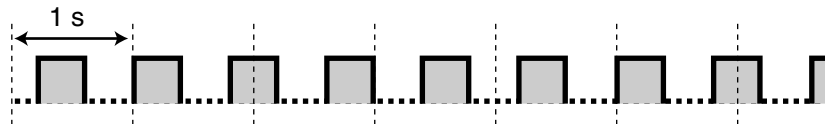

[Brazil only]



[Czech Republic only]

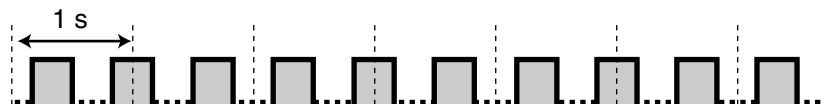

### Reorder Tones

The outside (CO) line you tried to seize is not assigned or was denied.



[Brazil only]



[Czech Republic only]



[Malaysia only]

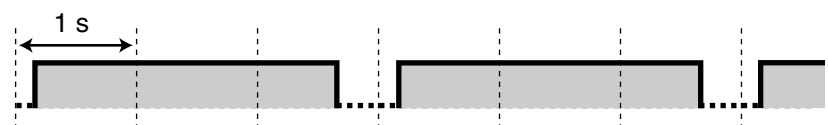

### 4.3 Identifying Tones

#### Ringback Tones

Single (3-s interval)



Double (3-s interval)

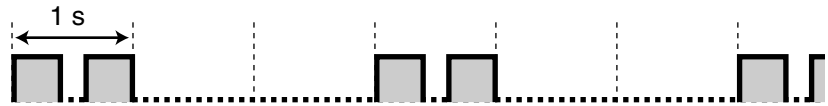

Single (5-s interval)



Double (5-s interval)



#### DND Tone

The dialled extension is refusing incoming calls.



### While Off-hook

#### Indication Tones

**Tone 1 (Call Waiting Tone)**

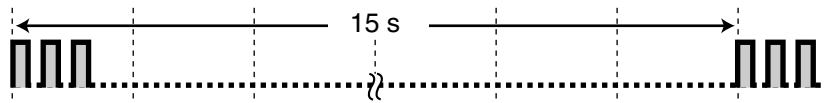

**Tone 2 (Call Waiting Tone)**

Single



Double



Triple



**Tone 3 (Hold Alarm Tone)**

A call has been on hold for longer than the specified time.

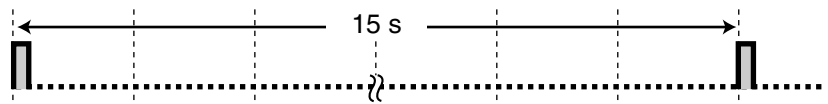

## When Talking to an Outside Party

### Warning Tone

This tone is sent 15 seconds before the specified time for disconnection.



## When Setting the Features or Programming

### Confirmation Tones

#### Tone 1

The feature was set successfully, or the Extension Lock feature was set or cancelled.



#### Tone 2

The new feature setting was the same as the previous setting, or certain features were successfully performed or accessed (e.g., Call Hold, Automatic Callback Busy).



#### Tone 3

Before the following features activate:

- Retrieving a held call
- Picking up another call
- Establishing a conference call
- Paging/Answering a paging announcement



## 4.4 Revision History

### 4.4.1 Version 2.0

#### Changed Contents

- 1.2.1 Basic Calling  
Calling an Outside Party
- 3.2 Managing Call Logs and Call Charges
- 4.1.1 Troubleshooting
- 4.3.1 Identifying Tones

---

# ***Index***

## Numerics

- 2-way Record 17, 105, 133
- 2-way Transfer 17, 106, 133
- 301st Incoming Call Logged in the Common Area 120, 155
- 3-level Automated Attendant 2
- 3-party Conference 58, 156
- 5-party Conference 60, 152

## A

- Absent Message 70, 152
- Accessing Another Party Directly from Outside (Direct Inward System Access [DISA]) 41
- Accessing External Services (External Feature Access [EFA]) 99
- Account Code Entry 24, 150
- Adding a Third Party During a Conversation (3-party Conference) 58
- Alternate Calling—Ring/Voice 39, 156
- Alternate Receiving—Ring/Voice 130
- Answering a Call from Another Telephone (Call Pickup) 46
- Answering a Call Ringing at Another Telephone (Call Pickup) 46
- Answering Call Waiting 55
- Answering Call Waiting from the Telephone Company 57
- Answering Call Waiting in the PBX 55
- Answering Calls 44
- Answering Hands-free (Hands-free Answerback) 45
- Answering/Denying a Paging Announcement 85
- Appendix 145
- AUTO ANS (Auto Answer)/MUTE 15
- AUTO DIAL/STORE 15
- Automated Attendant (AA) 43
- Automatic Callback Busy (Camp-on) 31, 156
- Automatic Callback Busy Cancel 32
- Automatic Line Access 21, 150
- Automatic Redial 29, 30

## B

- Background Music (BGM) 91
- Basic Calling 20
- Before Leaving Your Desk 67
- Before Operating a Telephone 12
- BGM → Background Music (BGM) 91
- BSS → Busy Station Signalling (BSS) 32
- Built-in Voice Message (BV) 2, 74, 153
- Busy Station Signalling (BSS) 32, 156
- Busy Tones 163
- BV → Built-in Voice Message (BV) 74

## C

- Call Forwarding (FWD) 67, 152
- Call Hold 50
- Call Hold Retrieve 51, 151
- Call Park 52, 152
- Call Park Retrieve 53
- Call Pickup 46, 151, 156
- Call Pickup Deny 47, 151
- Call Splitting 54
- Call Transfer 48
- Call Waiting 55, 89, 152, 154
- Call Waiting Tone 164

- Call Waiting Tone Type Selection 130
- Caller ID Indication—Common 17, 133
- Caller ID Indication—Personal 17, 132
- Caller ID Selection—Common 17, 133
- Caller ID Selection—Personal 17, 132
- Calling an Extension That Is Refusing Calls (DND Override) 37
- Calling an Outside Party 21
- Calling Other Extensions 20
- Calling to and from a Doorphone (Doorphone Call) 97
- Calling with the Incoming Call Log 107
- Changing Personal Settings Using Programming Mode 129
- Changing System Settings Using Programming Mode 123
- Changing the Dialling Mode (Pulse to Tone Conversion) 66
- Checking the Time Service Mode 93
- Clearing Features 130
- Clearing Features Set at Your Extension (Extension Feature Clear) 94
- CO 15
- Common BV OGM 74, 121
- CONF 16
- Conference 16, 58, 132
- Confirmation Tones 165
- Confirming Your Own Extension Number (Self-extension Number Confirmation) 131
- Connection Example 19
- Control Features 114
- Customised Buttons 16
- Customising the Buttons 132
- Customising Your PBX (System Programming) 138
- Customising Your Phone & PBX 127
- Customising Your Phone (Personal Programming) 128

## D

- Data Line Security 92, 154
- Date & Time Set 123
- Day 17, 132
- Dial Tones 161
- Dialling a Preset Number by Going Off-hook (Hot Line) 27
- Direct Inward System Access (DISA) 41
- Direct Message 75
- Direct Station Selection (DSS) 16, 132
- DISA Security Code [512] 142
- DISA Security Code Digits [530] 143
- DISA → Direct Inward System Access (DISA) 41
- Display 12
- Disregarding the Newest Call or Overwriting the Oldest Call in the Common Area Call Log (301st Incoming Call Logged in the Common Area) 120
- DND Override 37, 156
- DND Tone 164
- DND → Do Not Disturb (DND) 88
- Do Not Disturb (DND) 88, 152
- Door Open 98, 154
- Doorphone Call 97, 154
- Doorphone Chime Patterns 159
- During a Conversation 48

## E

- Easy Dialling 25
- EFA → External Feature Access (EFA) 99



- Electronic Station Lockout → Extension Lock 72, 152  
 Entering Characters 144  
 Erasing All Caller Information in the Common Area (Incoming Call Log in the Common Area—CLEAR ALL) 119  
 Examples 13  
 Exclusive Call Hold 50  
 Executive Busy Override 36, 156  
 Executive Busy Override Deny 90, 154  
 Extension Feature Clear 94, 154  
 Extension Lock 17, 72, 133, 152  
 Extension Lock—CANCEL ALL 123  
 Extension Password 40, 114, 125  
 Extension Password Set 123  
 External Feature Access (EFA) 99, 154
- F**
- Feature Highlights 2  
 Feature Number Table 150  
 Feature Numbers 12  
 Fixed Buttons 15  
 Fixed Line SMS Terminal Support 3  
 FLASH/RECALL 15  
 For Future Reference 8  
 Forwarding Your Calls (Call Forwarding [FWD]) 67  
 Forwarding Your Calls to a Voice Processing System (Voice Mail Integration) 100  
 Forwarding Your Calls to Built-in Voice Message 77  
 FWD → Call Forwarding (FWD) 67  
 FWD/DND (Call Forwarding/Do Not Disturb) 16, 132
- G**
- General Call Hold 50  
 Group-CO (G-CO) 16, 132
- H**
- Handset/Headset Selection → Headset Operation 64  
 Hands-free Answerback 45  
 Hands-free Operation 20, 23, 44, 65  
 Headset Operation 64  
 HOLD 15  
 Hold Alarm Tone 164  
 Holding 50  
 Holding a Call 50  
 Holding in a System Parking Zone (Call Park) 52  
 Hot Line 27, 150  
 How to Follow the Steps 18
- I**
- Icon Descriptions 13, 139  
 Identifying Tones 158  
 If a Doorphone/Door Opener is Connected 97  
 If a Host PBX is Connected 99  
 If a Voice Processing System is Connected 100  
 Incoming Call Log 107  
 Incoming Call Log Display Lock 72  
 Incoming Call Log in the Common Area—CLEAR ALL 119, 155  
 Indication Tones 164  
 INTERCOM 15
- Intercom Call 20, 150
- J**
- Joining an Existing Call (Executive Busy Override) 36
- L**
- Last Number Redial 29, 150  
 LCS Cancel 17, 133  
 LCS Password Control 123  
 LCS → Live Call Screening (LCS) 102  
 Leaving a Conference Call (Unattended Conference) 59  
 Leaving a Group (Log-in/Log-out) 73  
 Leaving a Message Waiting Indication/Calling Back a Caller Who Left an Indication (Message Waiting) 33  
 Leaving, Playing, or Erasing Voice Messages 78  
 Line Preference—Incoming 129  
 Line Preference—Outgoing 129  
 Live Call Screening (LCS) 17, 102, 133, 155  
 Live Call Screening (LCS) Mode Set 130  
 Locking Other Extensions (Remote Extension Lock) 114  
 Log-in/Log-out 17, 73, 133, 152  
 Lunch 17, 132
- M**
- Making Calls 20  
 Making/Answering a Paging Announcement 83  
 Manager Password 125, 135, 138  
 Managing Call Logs and Call Charges 135, 136  
 MESSAGE 15  
 Message 16, 132  
 Message for Another Extension 16, 133  
 Message Waiting 33, 151  
 Message Waiting for Another Extension Lock 36  
 Microphone Mute 63  
 MONITOR 15  
 Monitoring a Room (Room Monitor) 95  
 Muting a Microphone (Microphone Mute) 63
- N**
- Navigator Key 16  
 Night 17, 132
- O**
- One-touch Dialling 16, 25, 132  
 One-touch Transfer 48  
 Opening a Door (Door Open) 98  
 Operation 11  
 Operator Call 21, 150  
 Operator/Manager Operation 113  
 Originating a 3-party to 5-party Conference Call (5-party Conference) 60  
 Other-CO (O-CO) 16, 132  
 Outgoing Message (OGM) for DISA/UCD 41, 124  
 Outside (CO) Line Group Access 22, 150  
 Outside (CO) Line Ringing Selection 129
- P**
- Paging 83  
 Paging and then Transferring a Call 84

## Index

---

Paging Deny 85  
PAUSE 15  
Personal BV OGM 74, 75  
Personal Programming 128  
Personal Speed Dialling 26, 150  
Pickup Dialling → Hot Line 27, 150  
Preventing Other People from Joining Your Conversation (Executive Busy Override Deny) 90  
Preventing Other People from Picking Up Your Calls (Call Pickup Deny) 47  
Preventing Other People from Using Your Telephone (Extension Lock) 72  
PROGRAM 16  
Programmable Feature (PF) 16  
Programming Information 138  
Protecting Your Line against Notification Tones (Data Line Security) 92  
Pulse to Tone Conversion 66, 156

## Q

Quick Dialling 28

## R

Receiving Call Waiting 89  
Receiving Calls 44  
Recording a Conversation (2-way Record) 105  
Recording or Playing Outgoing Messages used by DISA, UCD, and 3-level AA 124  
Recording, Playing, or Erasing Common BV Outgoing Messages 121  
Recording, Playing, or Erasing Personal BV Outgoing Messages 75  
REDIAL 15  
Redialling 29  
Redialling the Last Outside Number You Dialed (Last Number Redial) 29  
Refusing Incoming Calls (Do Not Disturb [DND]) 88  
Remote Extension Lock 114  
Remote Station Lock Control → Remote Extension Lock 114  
Remote Timed Reminder (Wake-up Call) 117, 155  
Reorder Tones 163  
Requirements 135  
Reserving a Busy Line (Automatic Callback Busy [Camp-on]) 31  
Restrictions 13  
Revision History 166  
Ring Tone Patterns 158  
Ring Tone Patterns Sent from the Telephone Company (New Zealand only) 159  
Ringback Tones 164  
Room Monitor 95, 154

## S

Safety Instructions 4  
Save 16, 132  
Saved Number Redial 30  
Saving an Outside Phone Number for Redialling (Saved Number Redial) 30  
Screening Calls (Live Call Screening [LCS]) 102  
Self-extension Number Confirmation 131  
Sending a Call Waiting Tone to a Busy Extension (Busy Station Signalling [BSS]) 32  
Setting an Alarm for Other Extensions (Remote Timed Reminder [Wake-up Call]) 117

Setting Features 129  
Setting the Alarm (Timed Reminder) 86  
Setting the Telephone According to Your Needs 86  
Short Message Service (SMS) 3  
Showing a Message on the Caller's Telephone Display (Absent Message) 70  
Single-CO (S-CO) 16, 132  
SMS → Short Message Service (SMS) 3  
SP-PHONE 15  
Station Feature Clear → Extension Feature Clear 94, 154  
Station Programme Clear → Extension Feature Clear 94, 154  
Station Speed Dialling → Personal Speed Dialling 26, 150  
Switching the Calling Method (Alternate Calling—Ring/Voice) 39  
Switching the Time Service Mode (Time Service) 115  
System Password 125, 135, 138  
System Programming 138, 141  
System Speed Dialling 27, 150  
System Speed Dialling Name [011] 142  
System Speed Dialling Number [001] 141

## T

Talking to 2 Parties Alternately (Call Splitting) 54  
Talking to Another Party without Lifting the Handset (Hands-free Operation) 65  
Talking to Multiple Parties (Conference) 58  
TAM → Telephone Answering Machine (TAM) 46  
Telephone Answering Machine (TAM) 46  
Time Service 115, 155, 157  
Timed Reminder 86, 153  
Tone 12  
TRANSFER 15  
Transferring a Call (Call Transfer) 48  
Transferring to an Extension within the PBX 48  
Transferring to an Outside Destination 49  
Troubleshooting 146  
Turning on the Background Music (BGM) 91

## U

Unattended Conference 59  
Using a Display Proprietary Telephone 107  
Using a Navigator Key/Volume Key (depending on the type of your PT) 13  
Using a One-touch Button (One-touch Dialling) 25  
Using a Preprogrammed Number (Quick Dialling) 28  
Using an Account Code (Account Code Entry) 24  
Using Numbers Stored at Your Extension (Personal Speed Dialling) 26  
Using Numbers Stored in the PBX (System Speed Dialling) 27  
Using the Headset (Headset Operation) 64  
Using User-supplied Equipment 97  
Using Voice Messaging (Built-in Voice Message [BV]) 74  
Using Your Calling Privileges at Another Extension (Walking COS) 40

## V

Version 2.0 166  
VOICE CALL 16  
Voice Mail (VM) Transfer 17, 101, 133  
Voice Mail Integration 100, 154  
Volume Key 16

**W**

- Walking COS 40, 151
- Warning Tone 165
- What Kind of Telephone Can Be Used? 12
- When the Dialed Party is Busy or There is No Answer 31
- When You Use a Panasonic Proprietary Telephone 15

**Y**

- Your Extension Number 13

**Panasonic Communications Co., Ltd.**

1-62, 4-chome, Minoshima, Hakata-ku, Fukuoka 812-8531, Japan



**Copyright:**

This material is copyrighted by Panasonic Communications Co., Ltd., and may be reproduced for internal use only. All other reproduction, in whole or in part, is prohibited without the written consent of Panasonic Communications Co., Ltd.

© 2004 Panasonic Communications Co., Ltd. All Rights Reserved.